



Adhered



Hot Air Weld



Mechanically  
Fastened



Self-Adhering or  
Peel and Stick



# TPO Roofing Systems

## Commercial Roofing Application Guide



## Table of Contents

### **Section One**

Roof Insulation Application Guide .....	1-1
Roof Insulation Fastener Placement .....	1-3
Roof Insulation Attachment Patterns.....	1-10

### **Section Two**

TPO Membrane Application Guide.....	2-1
-------------------------------------	-----

### **Section Three**

TPO Mechanically Fastened Fastening Patterns .....	3-1
--	-----

### **Section Four**

TPO Flashing Details Code Key and Contents .....	4-1
TPO Flashing Details .....	4-7
Vapor Barrier Flashing Details .....	4-120



Download a free QR Reader app on your smart phone. When you see a QR code, use your phone to scan the code. It will then redirect your phone to a specific video or detail. These codes will allow you to view step by step instructional videos and will allow you to zoom in on details for better readability. If you are viewing this booklet online you can click on these codes to direct you to the online videos and details as well.

#### **Disclaimer:**

The TPO Roofing Systems Commercial Roofing Application Guide is intended as a guide only; actual conditions encountered during installation may vary from jobsite to jobsite. By providing this guidance, Johns Manville assumes no responsibility for quality of installation, field workmanship, building code compliance, or job safety. Johns Manville Material Safety Data Sheets (MSDS) are available with specific product safety information. For information on other Johns Manville thermal insulations and systems, call (800) 922-5922 or visit JM.com.

# 1

## **Roof Insulation Application Guide, and Fastening Patterns**



## Insulation Installation Considerations

It is important to know that all Johns Manville polyiso boards are printed with installation directions of “This side down”. This installation method is required for adhered systems and recommended when used under mechanically attached membranes.

Foam insulation products are combustible and should be properly protected from exposure to fire during storage, transit, and application.

### Storage

JM roof insulations (polyiso, Invinsa<sup>®</sup>, and FESCO<sup>®</sup>) are shipped with plastic shrouds that are intended to temporarily protect the insulation while in transit. JM continues to work on improving the packaging of our JM cover boards and insulation products. There are two packaging methods (plastic wrap or plastic bag) that are used depending upon the product and the manufacturing facility. No matter how packaged, JM insulation should not be stored in or around standing water. Since all packaging is 5-sided, the pallets should be elevated and stored on a finished surface rather than on dirt or grass. Exercise care during handling to prevent insulation damage; avoid pushing pallets off the truck, rolling pallets on the ground or roof, and removing the package support feet. No more insulation should be installed than can be completely covered with membrane on the same day.

- **Plastic Wrap Packaging** is shipped to the job site with tarps. At the job site this packaging is adequate for outside storage without tarps provided the insulation arrives intact with the original undamaged weather-tight plastic wrap, for two weeks or less.



For storage greater than two weeks, JM recommends slitting the plastic shrink wrap prior to covering the pallet with a breathable tarpaulin, to allow for venting. For storage greater than one month, insulation should be stored indoors in a dry, well-ventilated warehouse.

- **Plastic Bag Packaging** is shipped to the job site without tarps as this packaging protects the insulation during shipment. For storage less than two weeks, the packaging is adequate for outside storage without tarps provided the insulation arrives intact with the original undamaged weather-tight plastic bag. For storage greater than two weeks, JM recommends slitting the plastic shrink bag prior to covering the pallet with a breathable tarpaulin, to allow for venting. For storage greater than one month, insulation should be stored indoors in a dry, well-ventilated warehouse.



### Installation

Insulation must be independently fastened to the roof deck in mechanically attached and adhered systems. Adhering certain insulations in hot asphalt or cold adhesives is sometimes acceptable for adhered systems (only for 4x4 boards). For specific requirements, contact the JM Technical Services Group.

Always cut insulation to fit closely around all roof penetrations. Around drains, and primary scuppers, taper insulation a minimum of 36" x 36" (91.44 cm x 91.44 cm) for proper drainage.

Apply rigid insulation directly over fluted steel decks to provide smooth, continuous membrane support. Insulation should be installed with long edges parallel to the direction of the deck and supported by the deck flange. When butting insulation layers, do not allow the edge of either board to overlap an open flute. Cut the

insulation so the edge of the board is about at the center of, and supported by, the flange. Any gaps between insulation greater than 1/4" should be filled.

### Double Insulation Layers.

Installing roof insulation in multiple layers provides the designer with improved thermal performance. It also contributes to the overall performance of the roof system for the following reasons:

- Recent studies indicate that as much as 8% of the thermal efficiency of the insulation can be lost through the insulation joints and exposed insulation fasteners of single layer installations. Insulation joints that are staggered in multiple layer installations block the flow of heat.
- Multiple layer insulation installation reduces the stress accumulation of a thick, single insulation joint and distributes the stress more evenly over the multiple, thinner insulation joints.
- The bottom side of the membrane is protected from physical damage from insulation plates and fasteners by the second layer of insulation if the top layer is adhered.
- Roof decks may be stiffened.



### Asphalt Temperatures

JM endorses the guidelines established by the NRCA and ARMA for heating asphalt for proper insulation applications. Asphalt should be applied at the Equiviscous Temperature (EVT),  $\pm 25^{\circ}\text{F}$  ( $\pm 14^{\circ}\text{C}$ ).

### Cold Weather Application

Hot asphalt chills rapidly at  $40^{\circ}\text{F}$  ( $4^{\circ}\text{C}$ ). To avoid problems associated with "cold" asphalt application, insulation may be applied with mechanical fasteners. Another method when using hot asphalt may be the "mop and flop" method. The "mop and flop" method entails mopping the back of the insulation so that the asphalt retains its adhesive qualities for a longer period. When adhering insulation, including hot asphalt, board size shall not exceed 4' x 4' (1.22 m x 1.22 m). Care should be taken in any application below  $40^{\circ}\text{F}$  ( $4^{\circ}\text{C}$ ).

### Mechanical Application to Steel Decks

Mechanical attachment of insulation to steel decks is the only acceptable attachment method. For current information regarding Factory Mutual requirements over insulated steel decks, please check with a JM Technical Services Specialist, or the current FM Approvals<sup>SM</sup> RoofNav<sup>®</sup>.

### Adhesive Application

JM insulations may be installed in Insulation Adhesives:

- Two-Part Urethane Insulation Adhesive (2P-UIA)
- One-Step Foamable Adhesive
- Roofing Systems Urethane Adhesive

Board sizes shall not exceed 4' x 4' (1.22 m x 1.22 m). Refer to product data sheets for adhesive coverage rates.

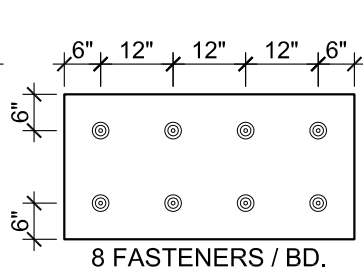
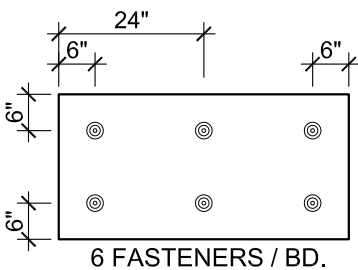
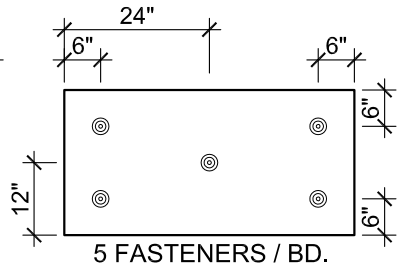
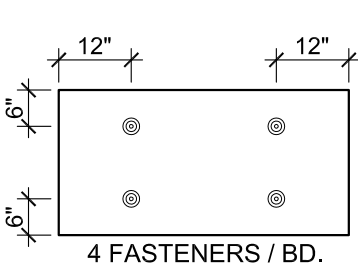
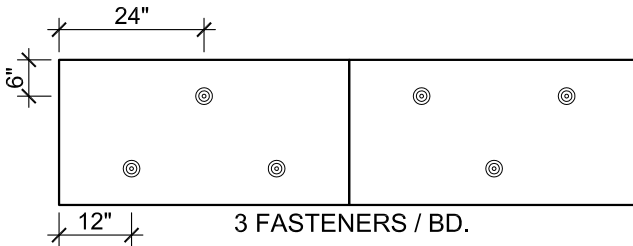
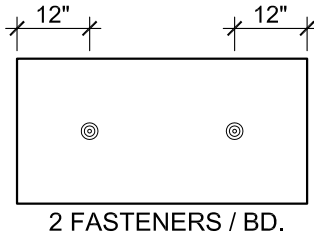

# Roof Insulations Fastener Placement

4' x 4' (1.22 m x 1.22 m) Boards

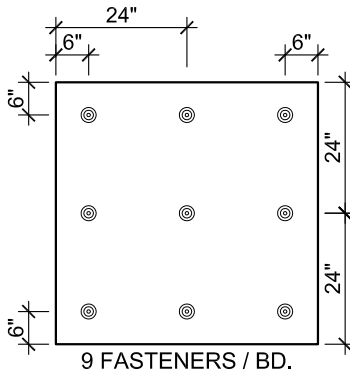
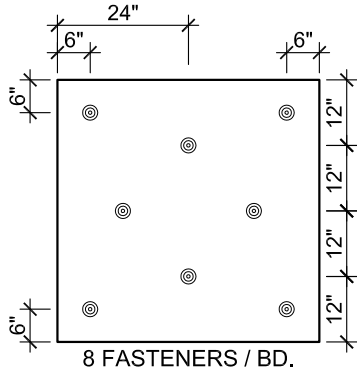
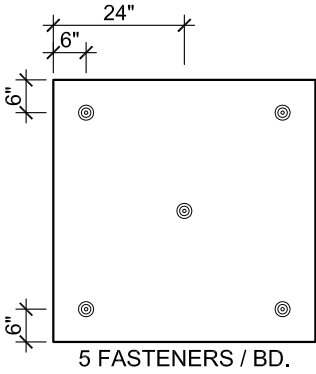
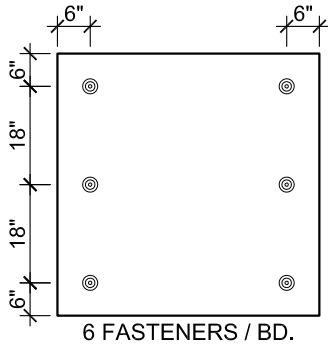
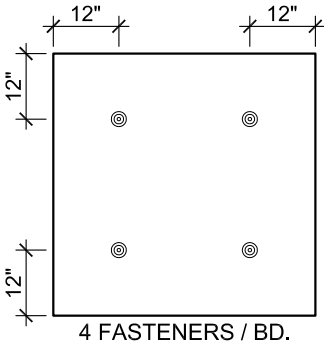

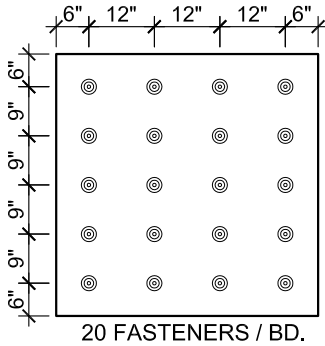
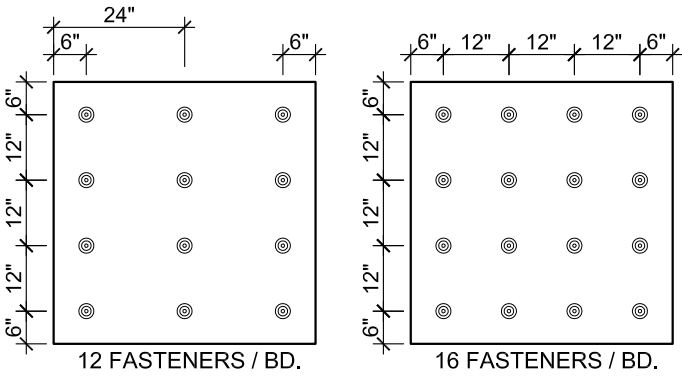
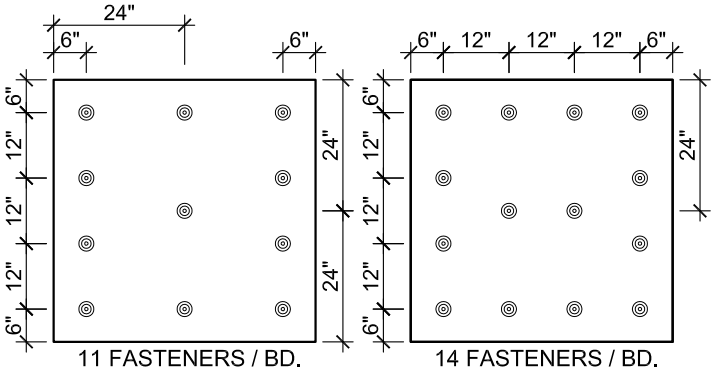

# Roof Insulations Fastener Placement

4' x 8' (1.22 m x 2.44 m) Boards

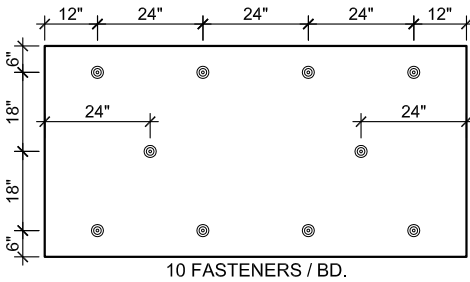
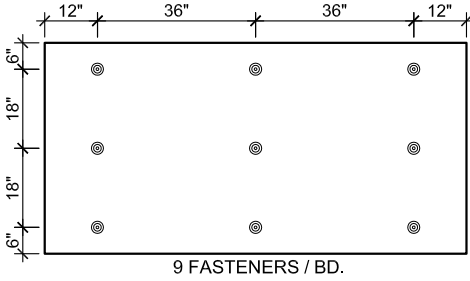
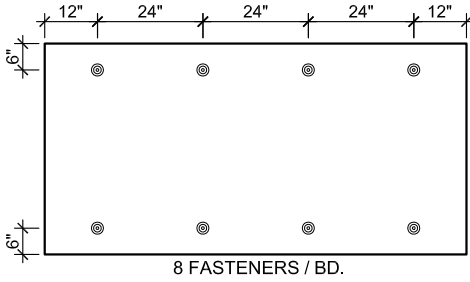
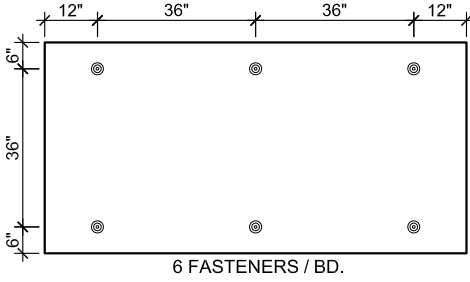
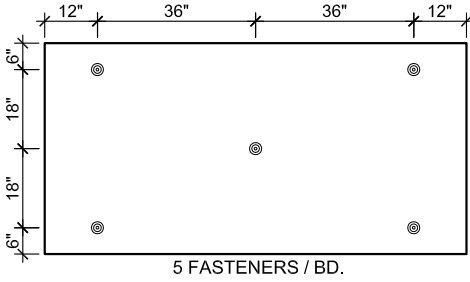

# Roof Insulations Fastener Placement

4' x 8' (1.22 m x 2.44 m) Boards

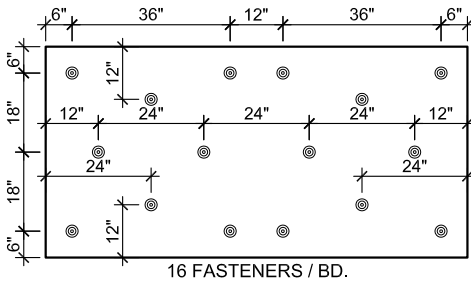
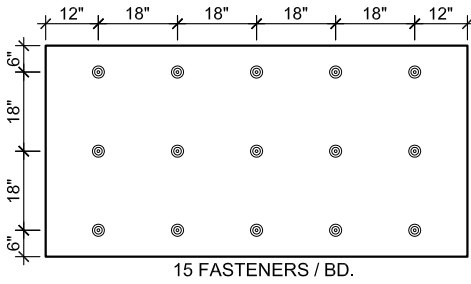
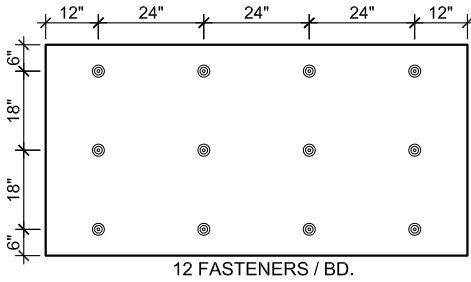
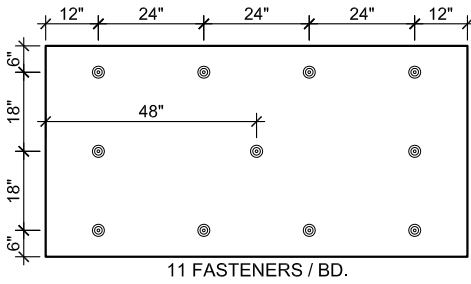

# Roof Insulations Fastener Placement

4' x 8' (1.22 m x 2.44 m) Boards

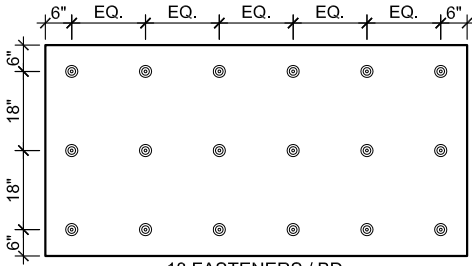

18 FASTENERS / BD.

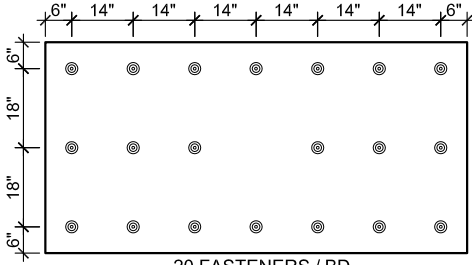

20 FASTENERS / BD.

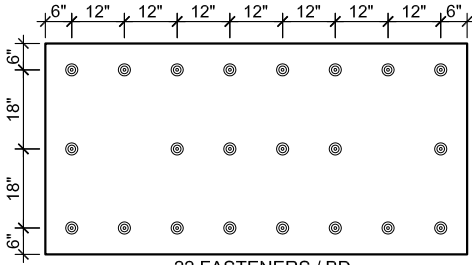

22 FASTENERS / BD.

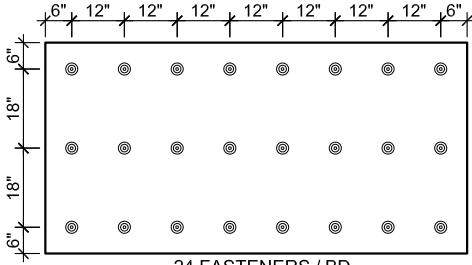

24 FASTENERS / BD.

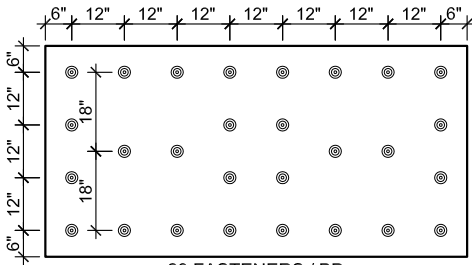

28 FASTENERS / BD.



# Roof Insulations Fastener Placement

4' x 8' (1.22 m x 2.44 m) Boards

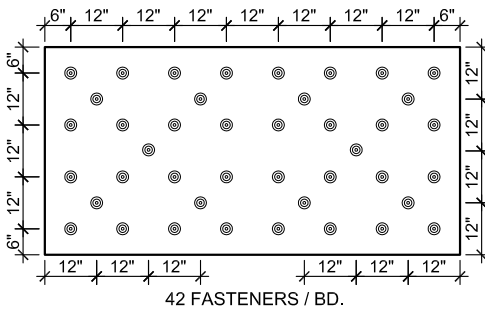
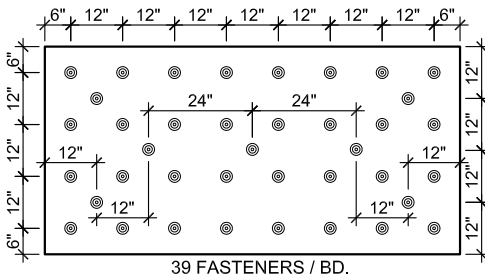
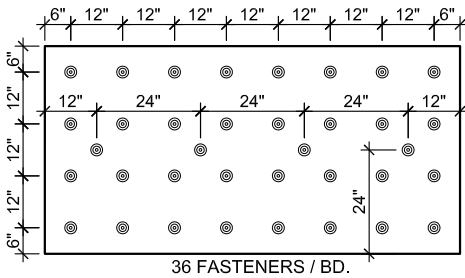
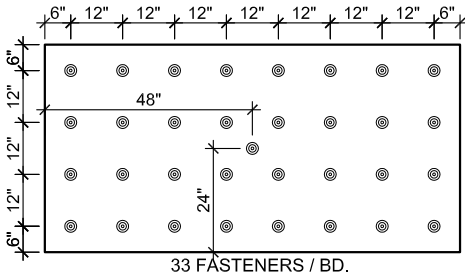
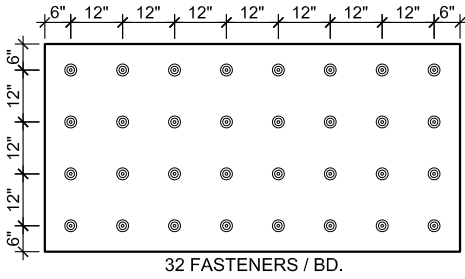

## BOARD LAYOUT

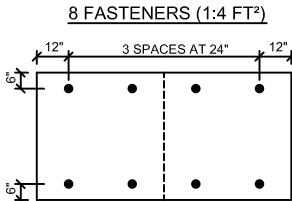
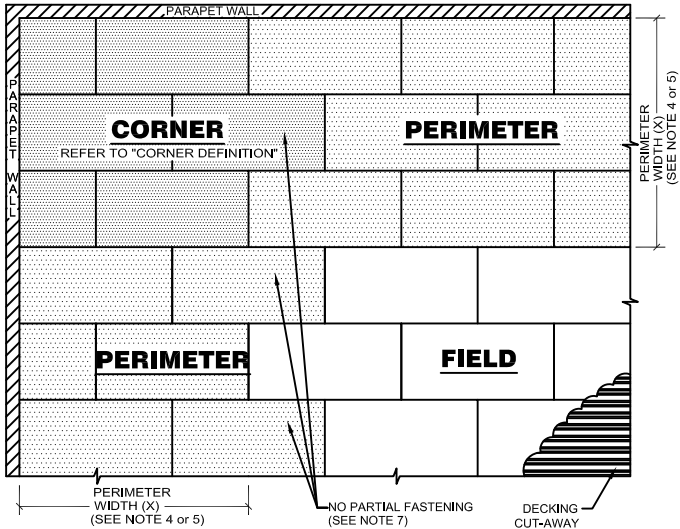

**FIELD**

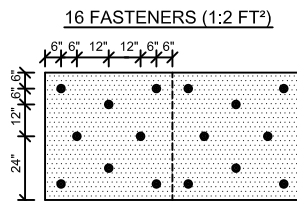

**PERIMETER**

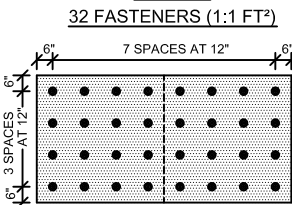

**CORNER**

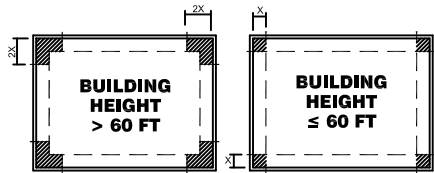

**CORNER DEFINITION**

(SEE NOTES 4, 5 & 6)

### NOTES

1. CALCULATE UPLIFT DESIGN PRESSURES IN ACCORDANCE WITH ASCE-7.
2. INSTALL INSULATION WITH LONG JOINTS IN A CONTINUOUS STRAIGHT LINE WITH END JOINTS STAGGERED.
3. ROOF HEIGHT  $\leq$  60 FT, THE PERIMETER (X) IS THE SMALLER DIMENSION OF:
  - 10% OF THE SHORTEST SIDE (PLAN VIEW)
  - OR
  - 40% OF THE ROOF HEIGHT,
  - BUT
  - NOT LESS THAN 4% OF THE SHORTEST SIDE (PLAN VIEW) OR 3 FT.
4. ROOF HEIGHT  $>$  60 FT, THE PERIMETER (X) IS:
  - 10% OF THE SHORTEST SIDE (PLAN VIEW) BUT NOT LESS THAN 3 FT.
5. THE CORNERS MAY BE TREATED AS PERIMETERS IF THE PARAPET IS GREATER THAN OR EQUAL TO 3 FT ON ALL SIDES ACCORDING TO ASCE-7.
6. IF ANY PORTION OF THE BOARD LIES IN A PERIMETER OR CORNER ZONE, ENHANCE THE FASTENING OF ENTIRE BOARD.

## BOARD LAYOUT

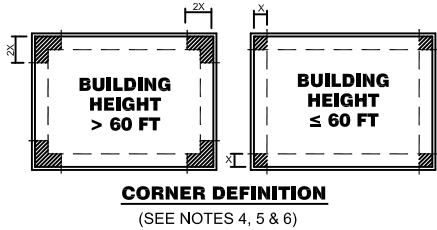
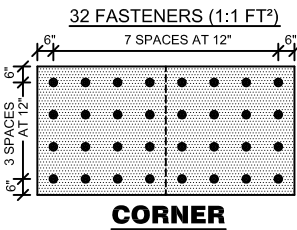
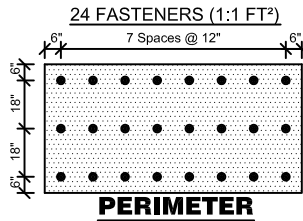
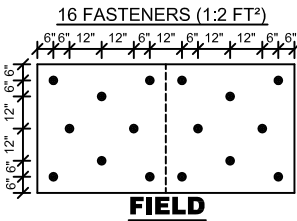
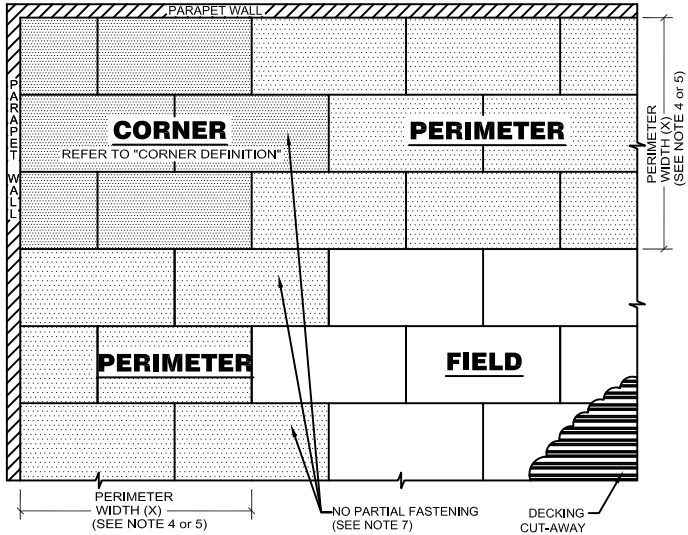

### NOTES

1. CALCULATE UPLIFT DESIGN PRESSURES IN ACCORDANCE WITH ASCE-7.
2. INSTALL INSULATION WITH LONG JOINTS IN A CONTINUOUS STRAIGHT LINE WITH END JOINTS STAGGERED.
3. ROOF HEIGHT  $\leq$  60 FT, THE PERIMETER (X) IS THE SMALLER DIMENSION OF:  
10% OF THE SHORTEST SIDE (PLAN VIEW)  
OR  
40% OF THE ROOF HEIGHT,  
BUT  
NOT LESS THAN 4% OF THE SHORTEST SIDE (PLAN VIEW) OR 3 FT.
4. ROOF HEIGHT  $>$  60 FT, THE PERIMETER (X) IS:  
10% OF THE SHORTEST SIDE (PLAN VIEW) BUT NOT LESS THAN 3 FT.
5. THE CORNERS MAY BE TREATED AS PERIMETERS IF THE PARAPET IS GREATER THAN OR EQUAL TO 3 FT ON ALL SIDES ACCORDING TO ASCE-7.
6. IF ANY PORTION OF THE BOARD LIES IN A PERIMETER OR CORNER ZONE, ENHANCE THE FASTENING OF ENTIRE BOARD.

### INSTALLATION NOTES:

- A. ALL INSULATION/COVER BOARDS SHOULD BE 4'-0" x 4'-0".
- B. WHEN APPLYING MULTIPLE LAYERS OF INSULATION, IT IS REQUIRED TO RUN THE BEADS PERPENDICULAR TO THE PRECEDING LAYER WHEN USING 1-PART JM URETHANE ADHESIVE. IT IS OPTIONAL WITH JM 2-PART URETHANE ADHESIVE.

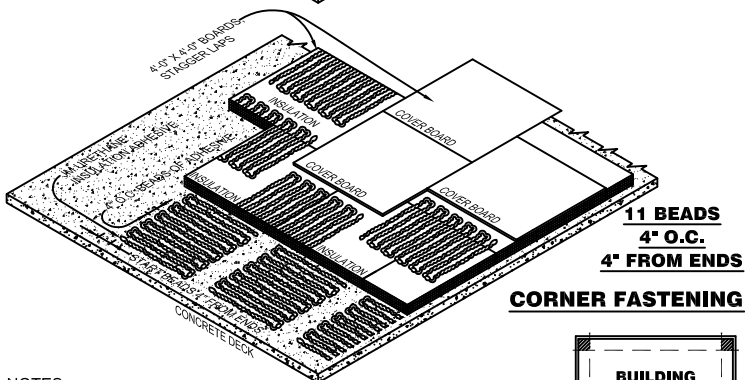
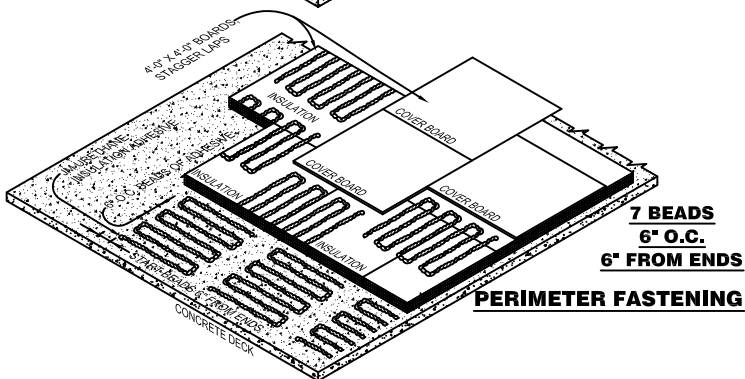
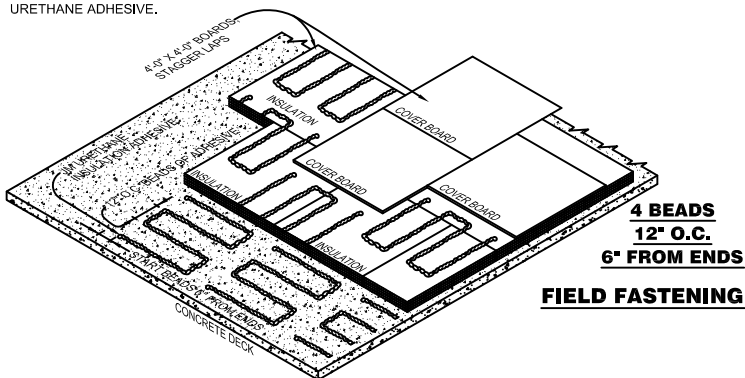

### NOTES:

1. UPLIFT DESIGN SHOULD BE IN ACCORDANCE WITH ASCE-7.
2. UPLIFT RESISTANCE SHOWN IS BASED ON FMG 1-29 REQUIREMENTS AND RECOMMENDATIONS.
3. SYSTEM COMPONENTS AND DESIGN MUST BE VERIFIED TO BE IN ACCORDANCE WITH THIS LAYOUT.
4. ASCE-7 DEFINES THE PERIMETER (X) AS THE LESSER OF 10% OF LEAST HORIZONTAL DIMENSION OR .4 x THE HEIGHT, BUT NOT LESS THAN 4% OF LEAST HORIZONTAL DIMENSION OR 3 FEET FOR BUILDINGS UNDER 60 FT. IN HEIGHT. OVER 60 FEET IN HEIGHT, ASCE-7 DEFINES THE PERIMETER (X) AS THE LESSER OF 10% OF LEAST HORIZONTAL DIMENSION ONLY.
5. THE CORNERS MAY BE TREATED AS PERIMETERS IF THE PARAPET IS GREATER THAN OR EQUAL TO 3 FEET ACCORDING TO ASCE-7.

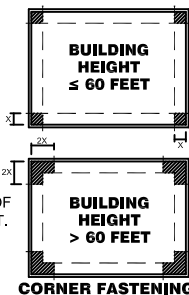

**INSTALLATION NOTES:**

- A. ALL INSULATION/COVER BOARDS SHOULD BE 4'-0" x 4'-0".
- B. WHEN APPLYING MULTIPLE LAYERS OF INSULATION, IT IS REQUIRED TO RUN THE BEADS PERPENDICULAR TO THE PRECEDING LAYER WHEN USING 1-PART JM URETHANE ADHESIVE. IT IS OPTIONAL WITH JM 2-PART URETHANE ADHESIVE.

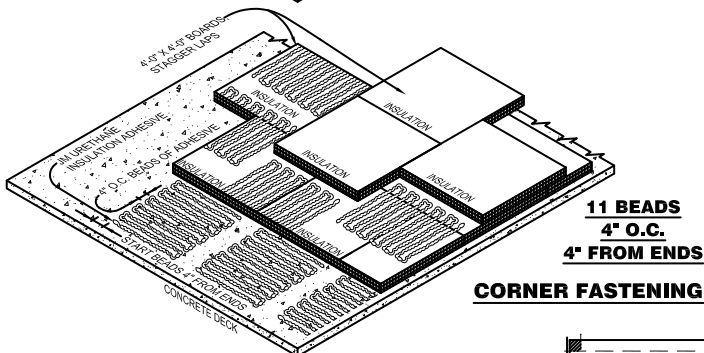
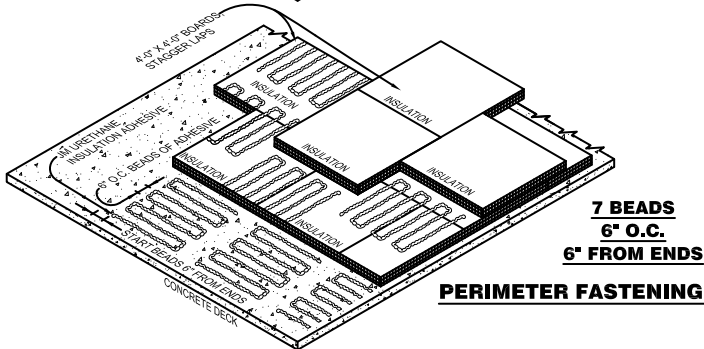
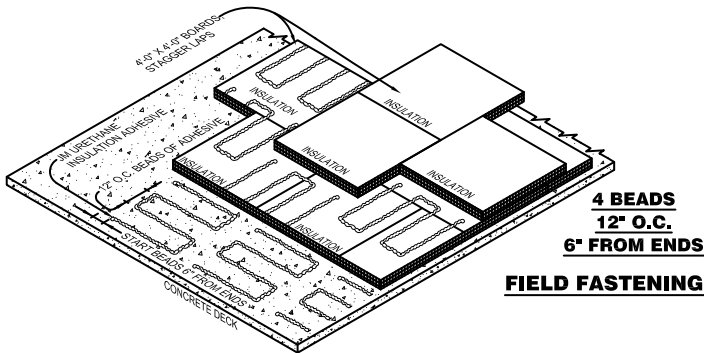

**NOTES:**

1. UPLIFT DESIGN SHOULD BE IN ACCORDANCE WITH ASCE-7.
2. UPLIFT RESISTANCE SHOWN IS BASED ON FMG 1-29 REQUIREMENTS AND RECOMMENDATIONS.
3. SYSTEM COMPONENTS AND DESIGN MUST BE VERIFIED TO BE IN ACCORDANCE WITH THIS LAYOUT.
4. ASCE-7 DEFINES THE PERIMETER (X) AS THE LESSER OF 10% OF LEAST HORIZONTAL DIMENSION OR .4 x THE HEIGHT, BUT NOT LESS THAN 4% OF LEAST HORIZONTAL DIMENSION OR 3 FEET FOR BUILDINGS UNDER 60 FT. IN HEIGHT. OVER 60 FEET IN HEIGHT, ASCE-7 DEFINES THE PERIMETER (X) AS THE LESSER OF 10% OF LEAST HORIZONTAL DIMENSION ONLY.
5. THE CORNERS MAY BE TREATED AS PERIMETERS IF THE PARAPET IS GREATER THAN OR EQUAL TO 3 FEET ACCORDING TO ASCE-7.

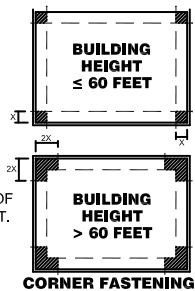



**Section Two:  
JM TPO Membrane Application Guide  
Assembly Plates & Fastening Patterns**

# 2

## **JM TPO Membrane Application Guide**

## Section Two Contents

<b>1.0 Introduction</b> .....	<b>2.2</b>
<b>2.0 Roof Substrate Materials and Deck Preparation</b> .....	<b>2.3</b>
<b>3.0 Mechanically Fastened Systems</b> .....	<b>2.5</b>
<b>4.0 Adhered Systems</b> .....	<b>2.8</b>
<b>5.0 Self-Adhered Systems</b> .....	<b>2.13</b>
<b>6.0 TPO Membrane with Redundant Bituminous Ply Sheets (Hybrid Systems)</b> .....	<b>2.18</b>
<b>7.0 Seaming, T-Joints, Penetrations, and Other Considerations</b> .....	<b>2.25</b>



Download a free QR Reader app on your smart phone. When you see a QR code, use your phone to scan the code. It will then redirect your phone to a specific video or detail. These codes will allow you to view step by step instructional videos and will allow you to zoom in on details for better readability. If you are viewing this booklet online you can click on these codes to direct you to the online videos and details as well.

### Disclaimer:

The TPO Roofing Systems Commercial Roofing Application Guide is intended as a guide only; actual conditions encountered during installation may vary from jobsite to jobsite. By providing this guidance, Johns Manville assumes no responsibility for quality of installation, field workmanship, building code compliance, or job safety. Johns Manville Material Safety Data Sheets (MSDS) are available with specific product safety information. For information on other Johns Manville thermal insulations and systems, call (800) 922-5922 or visit JM.com.

## 1.0 Introduction

This guide is designed for your convenience. These step-by-step instructions and illustrations should answer your installation questions and help you maintain top-quality craftsmanship when applying a JM TPO roofing system.

JM TPO Membranes are manufactured to meet a wide range of roof construction requirements. These membranes are used for mechanically attached, adhered, and induction welded roofing systems and are not intended for ballasted roofs.

Each membrane sheet is marked along the edge with lap lines. These lap lines indicate the minimum overlap required for mechanically fastened systems. A minimum 1½" (3.81 cm) welded seam is required for all systems.

### Equipment

The following equipment may be needed to install JM TPO roofing systems:

#### Power Equipment

- 10,000 - 12,000 Watt Generators
- 100' 120V or 240V Extension Cord
- Screw Guns
- Hand-Held Hot Air Welder
- Robot Welder
- Hammer Drill
- Electric Drill
- Rhinobond Induction Welder and Magnets

#### Required Hand Tools and Equipment

- Brooms (Soft and Stiff)
- Gloves
- Measuring Tape
- Eye Protection
- Caulk Gun
- Scissors
- Silicone Rubber Roller
- Wire Brush
- Chalk Line
- Lawn Or Linoleum Roller
- Drill Bits (Carbide, Steel)
- Seam Probe
- First Aid Kit
- Utility Knives
- Rags
- Writing/Marking Instruments
- Rollers and Brushes
- Site Specific PPE

#### Misc Tools

- Rivet Gun
- Snips
- Hammer
- Pull-Out Tester
- Reciprocal and Circular Saw
- Hand Saw
- Metal Crimpers
- Vise-Grip Pliers
- Pliers
- Ladder
- Screwdriver Set
- Aluminum Tape
- Adhesive Applicator Gun or Cart
- T-Square
- Rubber Mallet
- Stirring Sticks
- Paddle Mixer
- Silicone Rubber Roller
- Shovels
- Tongs

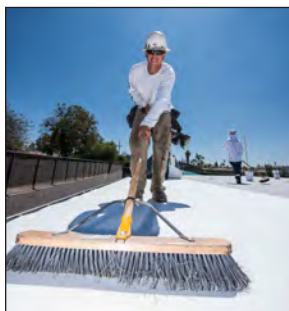



## 2.0 Roof Substrate Materials and Deck Preparation

The primary function of a roof deck is to provide structural support and restraint for the roofing system. The deck must have adequate strength and rigidity to support all anticipated live and dead loads, foot or construction traffic, wind, rain and snow loads. The deck must have adequate strength and rigidity to carry the weight of the roofers and their equipment during construction, without deflecting to the point where roofing components rupture, delaminate or are weakened.

Some decks are designed to furnish inside appearance as well as sound control; however, JM's concern is for the roof deck as a base for the roofing system. To perform this function, the deck must be rigid. It must be smooth and free of large cracks, holes or sharp changes in elevation of the surface. It must be able to receive the roof system by some method which will hold the system securely, either by adhesion, ballast or mechanical fasteners. Before roofing work is started, the deck should be inspected carefully by the roofing contractor, the deck contractor and the owner's representative, to determine that it satisfies these conditions. The roofing contractor and JM are only concerned that the surface of the deck will accept the roofing system. Neither JM nor the roofing contractor have any responsibility regarding the adequacy of the deck from a structural standpoint.

Surface preparation should include filling and smoothing all holes, depressions, irregularities, etc., before the roof is applied.

Roof-mounted equipment should not rest on the deck or roofing system. It should be supported by the structural framing of the building. Leaks resulting from improperly mounted rooftop equipment are excluded from coverage under the JM Peak Advantage® Guarantee.

To be a satisfactory substrate for any roofing system, a roof deck must have:

1. Proper construction, following the deck manufacturer's instructions.
2. Proper design to carry maximum anticipated live and dead loads which may be encountered during and after construction, without excessive deflection.
3. Positive drainage which will not allow water to pond. (See Roof Drainage paragraphs in this section.)
4. Expansion joints to allow for movement of the structure without causing strain on the roofing membrane. To be effective, expansion joints must extend through all elements of the roof and structural system.
5. A smooth, dry and properly cured surface to which the roofing system can be installed.
6. A solid, rigid assembly when using precast deck units. Units must be securely fastened to supporting members to prevent movement.
7. A continuous, uninterrupted surface. Installation of conduits on the top surface of a roof deck is not acceptable, unless the area between the conduits is filled with an acceptable roof insulation, properly secured, and a full thickness of roof insulation is installed over the conduits.
8. A clean surface. Before roofing application is started, the deck should be free of all dust, dirt, debris and foreign material. Only the roofer's tools and equipment should be allowed on the deck during roof application.
9. The proper resistance to wind uplift to prevent rupture of the roof membrane.
10. Adequate means of membrane securement. Provisions for special attachment procedures must be made on steep-slope decks.
11. Appropriate termination details. Under certain conditions, consideration should be given to isolating the roof membrane from stresses caused by deck or structural movement. This can be accomplished by securing base flashing to curbs attached to the structural deck. (See System Application section for flashing details.)

Any decks or substrates not listed in the current JM Commercial Roofing Product Manual must be approved by a JM Technical Services Specialist in writing prior to the installation of a roof which is to receive a Peak Advantage® Guarantee. Such approval only indicates that JM accepts the deck surface to receive a JM roofing system. **By such acceptance, JM accepts no responsibility of the structural adequacy or performance of the deck.**

## Nailers

After properly preparing the roof deck, install wood nailers when required. Place nailers on the perimeter of the roof, along the top of parapet walls and, where required, around roof penetrations and along roof expansion joints. Set the height of the nailers slightly lower than the height of the roof insulation (approx. ¼"). This will promote positive drainage across the edge where necessary and reduce the possibility of ponding at the edge of the building.

Space fasteners for wood nailers per the job specifications, but not greater than 24" (60.96 cm) o.c. with at least three fasteners per nailer, depending on nailer length. Each fastener must resist a minimum pull-out force of 200 lb/ft (298 kg/m) in any direction. Refer to FM data sheet 1-49 for wood nailer securement design considerations.

JM TPO-Coated Metal Flashings are fastened to wood nailers. When using membrane flashings, fasten the field sheet to the deck with a fastener/plate system.

## Vapor Retarders

Vapor retarders prevent moisture or condensation from entering the building or passing from the building into the roof system. To provide an effective shield against water vapor, seal off all vapor retarders at roof edges and penetrations.

## Air Barriers

Air barriers should be considered on jobs where high internal air pressure exists, such as airport hangars or distribution warehouses with many outside openings (such as loading docks), outdoor amphitheaters, etc.

## Insulation

Refer to Roof Insulation Application Guide in Section One for details.

## Slip sheets

When a slipsheet is used under the membrane on a mechanically attached system fasten with the sufficient amount of fasteners to keep all laps and edges secure. It should be neatly cut to fit closely against roof edges and around penetrations.

## Coal Tar Pitch

Coal tar pitch roofs give off vapors which can affect JM TPO roofing membranes. You must separate coal tar pitch roofs from the JM TPO Membrane in the following manner:

- Place insulation with a minimum thickness of 1½" (3.81 cm) atop the roof, with the joints of the insulation butted together at all four sides.

## Roof Preparation (Re-Roofing)

Proper roof substrate preparation is essential to simplify installation and prevent future conditions that may lead to roof leaks.

First, complete a moisture scan and ensure that any wet materials are clean and dry. Provide protection of the adjacent roof areas. Carefully sweep all roof surfaces to remove all debris and dirt. Make sure the roofing area is completely smooth. Be sure to power wash the substrate prior to installation especially in adhered systems. Cut out large blisters on asphalt or coal tar pitch roofs. Repair holes or cracks in concrete, greater than ¼" (6.35 mm) wide with non-shrink grout.



## 3.0 Mechanically Fastened Systems

### Assembly Identification

#### Membrane Thickness

4 = 45 mil (1.14 mm)

6 = 60 mil (1.51 mm)

8 = 80 mil (2.03 mm)

#### Membrane Type

R = Reinforced

P = Polyester Fleece Backed

S = Single Ply

# ST6RM

#### Attachment

M = Mechanically Attached

R = RhinoPlate Attached

TPO Membrane

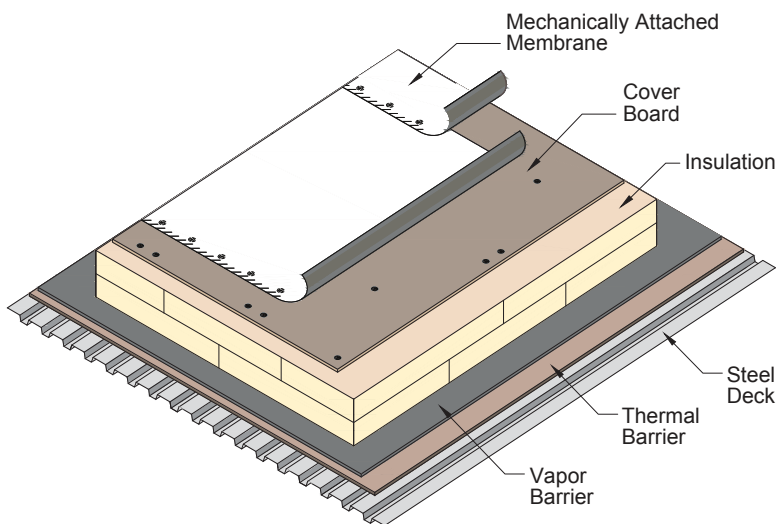

**NOTE:** For additional assembly plate variations, check out our interactive form online.

### Installing Membranes

Unroll the JM TPO Membrane and position without stretching. Allow the membrane to relax at least 15 minutes when the temperature is above 60°F (16°C), or 30 minutes when the temperature is below 60°F (16°C), prior to installation. Inspect for any damaged membrane. Remove sections of the membrane that are creased or damaged. Pay special attention to membrane creasing at temporary tie-ins as this will be permanent.

Install all roof deck materials (vapor retarders, insulation and slip-sheet) in complete sections, and cover with the membrane immediately to produce weather-tight sections each day. **Phased construction is not permitted.**

For mechanically attached systems on steel decks, the membrane sheets must be applied **perpendicular** to the flutes of the deck.

To prevent wind uplift and secure the membrane on mechanically attached roofs, fasten the membrane to the roof deck with metal plates and acceptable fasteners.

## Perimeter Areas

Refer to the local code requirements, project specifications, JM guarantee requirements, or FM Global® requirements when determining fastener rates.

The requirements to calculate perimeter areas are as follows:

1. **Roof Height  $\leq$  60 ft.**, the perimeter is the smaller dimension of: 10% of the shortest side (plan view), or 40% of the roof height, but not less than 4% of the shortest side (plan view) or 3 feet.
2. **Roof Height  $>$  60 ft.**, the perimeter is: 10% of the shortest side (plan view) but not less than 3 feet.
3. For mechanically fastened systems, spacing between fastener rows should be no greater than 60% of the width of the field sheets in the perimeters, and no greater than 40% of the width in the corners.
4. For induction welded systems, fastener rate (contributory area) shall be no greater than 60% of the field fastener rate.

## Corner Areas

All corners shall be the intersections of the perimeter areas. Refer to the local code requirements, project specifications or FM Global requirements when determining corner layouts for perimeter sheets. If parapets are greater than 36" continuous the corners may be treated as a perimeter. Typically, one of the following layouts is used in the corners:

1. The perimeter rolls should be fastened all the way into the corner. The other perimeter sheets are fastened up to the previously installed perimeter sheets, and then the fastener rows are continued to the corner through the top of the previously installed sheets. Install a cover strip of reinforced membrane extending 2" (5.08 cm) on each side over the fasteners for a watertight seal. This method is commonly referred to as "picture framing".
2. The perimeter rolls should be run perpendicular to the flutes in steel deck applications. Additional fasteners should be installed in rows that are no greater than 40% of the width of the field sheets. These fastener rows should then be stripped in with reinforced JM TPO Membrane or JM TPO Reinforced Cover Strip. This method is commonly referred to as the "finger" method.
3. For induction welded systems, fastener rate (contributory area) shall be no greater than 40% of the field fastener rate.

## General Suggestions to Avoid Problems in Cold Weather (Below 50°F [10°C])

1. Store all JM TPO materials in warm 60°F – 80°F (16°C – 27°C), dry area away from sparks and open flames, to avoid condensation problems that could affect weld quality. Protect from freezing.
2. Take at least twice the usual number of seam samples to test for shear strength, since the possibility of inferior welds is greater.
3. Thoroughly dry all weld surfaces prior to welding.
4. **Exercise caution when walking on dew, frost, ice or snow covered roofs, since the membrane may be extremely slippery.**
5. Allow membrane to relax for a longer period of time.
6. Allow for extended adhesive flash off times.

## In-Lap Mechanically Fastening

### The In-Lap Method

1. Roll out one roll of membrane over the acceptable substrate. Let it relax 15 to 30 minutes or as needed to compensate for any residual roll tension.
2. Secure the plate along the edge of the membrane, maintaining at least a ½" (1.27 cm) distance from the edge of the plate to the outer edge of the roll. Fastener and plate spacing is per FM Global requirements and/or job specifications or to meet JM guarantee requirements.
3. Tightly screw down the plates (do not overdrive the fastener) using an appropriate screw gun unit with adjustable clutch. Make certain to drive the fastener perpendicular to the surface of the substrate and to properly penetrate the deck surface. On steel decks, the screws must be fastened into the top flanges of the metal deck.
4. After securing the edge of the first membrane roll, roll out the next adjacent roll of membrane. Position this roll so that its common edge fully overlaps the row of plates and fasteners just installed. Maintain a minimum overlap of 6" (15.24 cm) (depending on plate size) to cover the plates, and leave the required ½" (3.81 cm) minimum for the seam weld.
5. Weld the overlap seam. Apply a bead of liquid JM TPO Edge Sealant along all cut edges of the seam.



## Induction Welding

### Insulation Attachment

Insulation must be fastened to the roof deck in TPO induction welded roof systems per the appropriate fastening pattern details, depending on membrane type and uplift requirements. For specific requirements, contact your JM Technical Services Specialist at (800) 922-5922. **NOTE: JM TPO induction weld plates must be used in JM TPO systems; JM TPO and JM PVC induction weld plates are not interchangeable. Note that TPO induction weld plates are gold.**

**Do not overdrive** the plate and fasteners, as this will lead to poor bonding/adhesion to the membrane when applied.

Take caution to ensure there is **no moisture on the board or membrane** prior to application. Any water or dew will decrease the bonded welding circumference. Induction weld plates are only approved for TPO membranes that are 60 mil thick and greater.

### Induction Weld Method

1. Roll out one roll of membrane over the acceptable substrate. Let it relax 15 to 30 minutes or as needed to compensate for any residual roll tension.
2. Perform calibration and set up as detailed by the induction welder's owner's manual. Refer to the induction welder's owner's manual for setup, calibration and welding.
3. Center the induction welder over the first plate in the pattern and activate the weld. **WARNING:** The induction welder must be centered over the plate to create a 100% bond. If an error occurs during activation, refer to the induction welder owner's manual for corrective action.



4. Immediately place a cooling magnet over the welded plate. **WARNING: Keep magnet in place for at least 45 seconds while the assembly cools.**

5. Repeat process for each plate.

**To increase the pace**, work across the sheet, moving cooling magnets from one row to the next as needed. It is best to work in the direction of the aligned rows.

**To eliminate damage to the membrane**, keep the magnets and surface of membrane clean and free from debris or contamination both prior and during the induction welding process. Always wipe the magnet clean when moving to the next plate. When removing the magnet do not twist it off, as it may damage the membrane.

**To determine if a weld has been made**, place the plunger next to a welded plate and create enough suction to lift the membrane. If welded, you will see a complete round outline of the plate. If the assembly is not welded, the membrane will lift up from the plate. Mark any plates that are not welded as a reminder to complete the weld.

**Safety Guidelines:** Induction welding requires special safety precautions prior to, during and after installation. When working with welding equipment, contractors must use extra care and extreme caution to prevent accidents. Carelessness can lead to loss of life, injury and loss of property. Installers should always reference the manufacturer's user manual for how to properly use the equipment.



## 4.0 Adhered Systems

### Assembly Identification

**Membrane Thickness**

- 4 = 45 mil (1.14 mm)
- 6 = 60 mil (1.51 mm)
- 8 = 80 mil (2.03 mm)

**Membrane Type**

- R = Reinforced
- P = Polyester Fleece Backed

# ST6RA

**S = Single Ply**

**TPO Membrane**

**Attachment**

- A = Adhered
- U = Urethane Adhesive

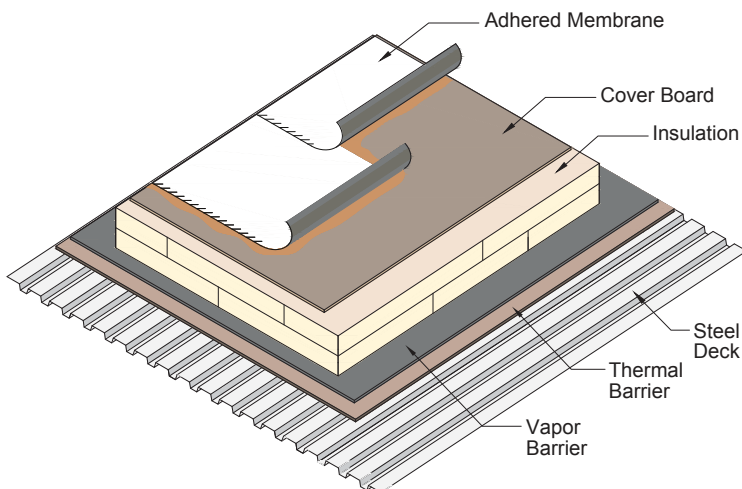

**NOTE: For additional assembly plate variations, check out our interactive form online.**

All membranes and substrates to be adhered must be approved by Johns Manville. Both surfaces must be clean, smooth, dry, compatible and free of contaminants and grease/oil. All fasteners, if required, must be properly seated and plates flush, leaving an acceptable surface to receive adhesive.

1. Roll out one roll of membrane over the acceptable substrate. Let it relax 15 to 30 minutes or as needed to compensate for any residual roll tension.
2. Position the membrane with a minimum 2" (5.08 cm) overlap between sheets. Fold membrane back one-half of the length of the first sheet's length to expose its bottom side.
3. Make sure adhesive container is sealed. Turn upside down and wait a minimum of five minutes then turn containers right side up. Carefully open and vigorously stir until adhesive is a uniform color and all solids are dispersed, with NO SWIRLS.
4. Saturate roller by dipping into can. Roll adhesive onto substrate and membrane for smooth-backed membrane, and substrate only for fleece-backed membrane.
5. When adhesive is ready, carefully roll the membrane into the substrate avoiding wrinkles. Apply even pressure with a broom to ensure good contact between the membrane and substrate. Go back over the membrane with a lawn or linoleum roller (minimum 75 lb [34 kg]) to ensure no air pockets or voids occur.

Do not apply adhesive in the seam area; seams are to remain clean and dry. Avoid puddling of adhesive. With adhesives, more is not necessarily better. "Over-coating" adhesives will lead to poor adhesion.

Do not use in direct contact with polystyrene foam.

Adhesive coverage, open time and dry time rates can vary dramatically depending on the particular substrate and environmental conditions. Coverage rate charts, stated herein, are approximate only. If FM Global or UL® approval is required, please consult the specific RoofNav<sup>SM</sup> or UL Certification Directory for specific application rates.

## General Suggestions to Avoid Problems in Cold Weather (Below 50°F [10°C])

1. Store all JM TPO materials in warm 60°F – 80°F (16°C – 27°C), dry area away from sparks and open flames, to avoid condensation problems that could affect weld quality. Protect from freezing.
2. Take at least twice the usual number of seam samples to test for shear strength, since the possibility of inferior welds is greater.
3. Thoroughly dry all weld surfaces prior to welding.
4. **Exercise caution when walking on dew, frost, ice or snow covered roofs, since the membrane may be extremely slippery.**
5. Allow membrane to relax for a longer period of time.
6. Allow for extended adhesive flash off times.



Use our Roof TechXpert app on your phone to get more accurate flash time estimates based on your current location.

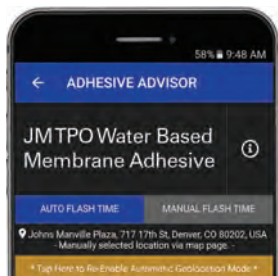

DOWNLOAD THE FREE APP



Suggested Coverage Rate Ranges				
Adhesive	Ft <sup>2</sup> /gal (gal/sq)			
JM Membrane Bonding Adhesive (TPO & EPDM)	90 (1.11)	80 (1.25)	70 (1.43)	60 (1.67) 50 (2.0)
JM TPO Water Based Membrane Adhesive	180 (0.56)	160 (0.63)	140 (0.71)	120 (0.83)
Insulation & Cover Boards	← Less Adhesive / More Adhesive →			
	Invisa/CGF			
	Gypsum*			
	ENRGY 3 (glass reinforced facer)			
				RetroPlus

\*Gypsum includes SECUROCK Gypsum-Fiber, DensDeck Primed, and DEXcell FA

**Notes:** 1. Listed rates are for finished areas 2. See JM requirements for correct application method. 3. One-sided Applications (water based): Apply the full amount to the substrate only 4. Two-sided Applications (all adhesives): Apply approximately half the listed rate to the membrane and the remaining amount to the substrate. For porous substrates such as wood and gypsum, apply more adhesive on the substrate.



## Solvent and Low VOC/Solvent-Based, Two-Sided Application for Plain-Backed (Smooth-Backed) Membranes

Apply solvent-based adhesive in a smooth, even, thin coat to both membrane and approved substrate at the rates listed on specific product data sheets. Most applications apply approximately half the listed rate to the membrane and the other half to the substrate.



For porous substrates such as wood and gypsum, apply more adhesive on the substrate.

**Do not allow adhesive on both sides to dry completely; if no longer tacky it cannot be used.** TPO systems require adhesive to become tacky to the touch on both surfaces without stringers. Time will vary depending on the ambient temperature and humidity.

### Cold Weather Application

Solvent and Low VOC/Solvent-Based Adhesives Cautions below 40°F

- **JM Membrane Bonding Adhesive should NOT be applied**
  - When ambient temperatures are 25°F (-3.8°C) or colder.
  - Adhesive temperature is at/below 32°F (0°C).
  - Adhesive containers must be stored in a warming hut 60°F – 80°F (16°C - 27°C) when ambient temperatures are at or below 40°F (4.4°C). Protect from freezing.



- Opened adhesive being installed in cold weather applications that drops in temperature to the freezing point shall be restored to room temperature prior to continued use.
- In high relative humidity or when the dew point is within 10° degrees of ambient temperature.



## Water-Based, Two-Sided Application for Plain-Backed (Smooth-Backed) Membranes

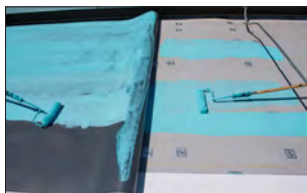

Apply water-based adhesive in a smooth, even, thin coat to both the membrane and approved substrate at the rates listed on specific product data sheets. Most applications apply approximately half the listed rate to the membrane and the other half to the substrate. For porous substrates such as wood and gypsum, apply more adhesive on the substrate.

Bright Blue

Dark Green

Wet

Ready to Adhere

Adhesive should be tacky at point of assembly; approximate time will vary depending on the environmental conditions. Once the adhesive begins to change color (bright blue to dark green) and feels tacky, but with no stringers (as with the solvent adhesive), carefully roll the membrane to the

substrate. Avoid capturing air or creating wrinkles during this process. If adhesive is completely dry or too wet (still bright blue), adhesion will be compromised. Apply even pressure to ensure good contact between the membrane and substrate.



## Water-Based, One-Sided Application for Fleece-Backed and Smooth-Backed Membranes Only

Apply the full rate of water-based adhesive to the substrate ONLY. Do not apply adhesive to the membrane. DO NOT apply to the membrane or in the weld area; keep both surfaces clean and dry. Assemble membrane and substrate while adhesive on the substrate is still wet. Apply even pressure with a lawn or linoleum roller (minimum 75 lb [34 kg]) to ensure good contact between the membrane and substrate.

Bright Blue

Wet

### Water-Based Adhesives Cautions

JM TPO Water Base Membrane Adhesive should be blue when laying the membrane into a one sided application.

#### • Water-based adhesives should NOT be applied:

- At temperatures below 40°F (or 5°C).
- At very high (>90%) relative humidity or when rain is expected.
- When the dew point\* and the ambient temperature does not have a separation of more than 10° F and is not expected to be more during application time.
- When temperatures can be expected to fall below the dew point during application and/or up to 6 hours post application.
- When temperatures are expected to fall below freezing within 48 hours of application.

\* Dew point definition - the temperature below which the water vapor in a volume of humid air at a given constant barometric pressure will condense into liquid water at the same rate at which it evaporates. Condensed water is called dew when it forms on a solid surface. The dew point is a water-to-air saturation temperature.

- Do not over apply. Use the coverage rate chart in this section; too much adhesive will result in curing issues.



## JM Roofing System Urethane Adhesive (RSUA) Installation Instructions

All applications must be approved by Johns Manville.

All surfaces must be clean, smooth, dry, compatible and free of dirt, debris, oil/grease and gravel. All fasteners, if required, must be properly seated and plates flush, leaving an acceptable surface to receive adhesive.

### JM RSUA Packaged in 1,500 ml Cartridges

Remove the molded cap at the top of the cartridge and attach the supplied static-mixing nozzle to the threaded mixing head. Place the cartridge into the appropriate JM RSUA applicator.

### JM RSUA Packaged in 5-Gallon Bladder

Remove bladder from box. Remove the white disc closure from the top of the packaging and extend quick-connect spouts in both Part 1 and Part 2 boxes. Invert bladder and place in appropriate tray on the Garlock Cyclone (or similar).

**Box labeled "Part 1" must be in area of tray labeled "Part 1" and box labeled "Part 2" in area labeled "Part 2."**

- Connect the black Part 1 fitting to the black inlet hose fitting
- Connect the gray Part 2 fitting to the gray inlet hose fitting
- Operate pump according to manufacturer's instructions
- On a scrap piece of material, dispense a small amount of RSUA. Let rise to ensure equipment and adhesive are on-ratio

### For Membrane Application

1. Unroll the membrane and allow it to relax at least 15 minutes before applying adhesive; longer time may be necessary in colder weather.
2. Position the membrane with a minimum 2" (5.08 cm) overlap between sheets.
3. Fold membrane back one-half of the length of the first sheet's length to expose its bottom side.

### For Board and Membrane Application

Apply JM RSUA directly to the substrate and allow it to begin to rise and build body before placing fleece-backed membrane or board stock into the adhesive.

- **Membrane attachment requires the membrane be rolled with a 150 lb roller to ensure positive contact between membrane, adhesive and substrate.**
- Board stock attachment requires the board stock to be walked in to ensure positive contact between the board stock, adhesive and substrate.
- Do not allow the adhesive to skin over. Eliminate uneven surfaces to ensure positive contact between the insulation board/ membrane and substrate.

### Typical Lock-Down/Tack-Free Times

Ambient Temperature	Lock Down/Tack Free Time
40°F	9-10 minutes
60°F	6-7 minutes
80°F	4-5 minutes
100°F	3-4 minutes

Unused material can be applied at a later date by simply plugging the cartridges (with provided caps) and using a new static mixing nozzle. When using the box packaging, properly clean dispensing wand and pump unit according to the pump manufacturer's recommendation.

## Coverage — Fleece-Backed Membranes

Bead spacing: 12" o.c. • Applied bead size: 3/4" min.

Packaging	Typical Coverage Rates		
	per package*	ft <sup>2</sup> /gal	gal/100 ft <sup>2</sup> *
Cartridge	600 ft <sup>2</sup> /case	189	0.5
5 gal	2,000 ft <sup>2</sup> /set**	200	
15 gal drum	6,000 ft <sup>2</sup> /set**		
50 gal drum	20,000 ft <sup>2</sup> /set**		

## Coverage — Fleece-Backed Membranes

Bead spacing: 6" o.c. • Applied bead size: 3/4" min.

Packaging	Typical Coverage Rates		
	per package*	ft <sup>2</sup> /gal	gal/100 ft <sup>2</sup> *
Cartridge	300 ft <sup>2</sup> /case	94	1.1
5 gal	1,000 ft <sup>2</sup> /set**	100	1.0
15 gal drum	3,000 ft <sup>2</sup> /set**		
50 gal drum	10,000 ft <sup>2</sup> /set**		

## Coverage — Fleece-Backed Membranes

Bead spacing: 4" o.c. • Applied bead size: 3/4" min.

Packaging	Typical Coverage Rates		
	per package*	ft <sup>2</sup> /gal	gal/100 ft <sup>2</sup> *
Cartridge	200 ft <sup>2</sup> /case	63	1.59
5 gal	667 ft <sup>2</sup> /set**	67	1.49
15 gal drum	2,000 ft <sup>2</sup> /set**		
50 gal drum	6,667 ft <sup>2</sup> /set**		

\* Coverage rates are approximate and may vary based on substrate type and application. Approved substrates include structural concrete decks, JM Vapor Barrier SA, ENRGY 3, RetroPlus, DuraBoard, Invinsa, Securock, DensDeck, DensDeck Prime, smooth modified asphalt membranes and granulated asphalt membranes. Please contact JM Technical Services for other approved substrates.

\*\* A set is defined as an equal Part 1 and Part 2.

## 5.0 Self-Adhered Systems

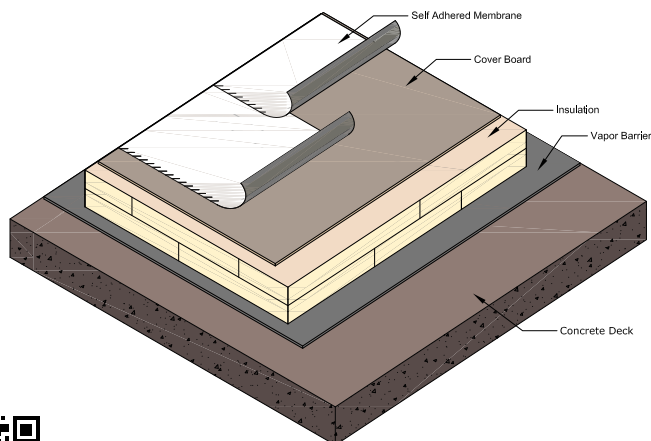
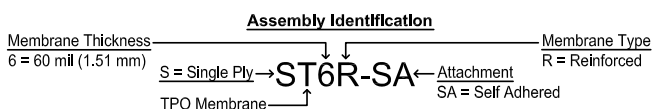

**NOTE:** For additional assembly plate variations, check out our interactive form online.

## General Information

The following section provides the application specifications currently available from Johns Manville (JM) for thermoplastic polyolefin membranes with self-adhering capabilities (TPO SA- Self-Adhered Membrane).

## Membrane Substrate

The surface on which the self-adhering thermoplastic membrane (TPO –SA) is to be applied shall be a JM approved roof insulation or cover board: ENRGY 3<sup>®</sup>, ENRGY 3<sup>®</sup> CGF, SECUROCK<sup>®</sup> Gypsum-Fiber Roof Board, DEXcell<sup>®</sup> FA Glass Mat Roof Board, DensDeck<sup>®</sup> Prime and Invinsa<sup>®</sup> Roof Board.

The surface must be clean, smooth, flat and dry. Any surface contamination should be removed to promote proper membrane adhesion.

## General Guidelines for Application of Materials

The proper application of roofing materials is as important to the satisfactory performance of the roof system as the materials themselves.

JM suggests the following guidelines for application of all roofing materials.

1. Don't use wet or damaged materials.
2. Never apply any roofing materials during rain or snow, or to wet surfaces. Moisture trapped within the roofing system as a result of this can cause severe damage to the roof membrane and insulation. Any product that has moisture contamination or is wet should be removed and discarded.
3. Review the guidelines for application for roof insulations, coatings and accessories shown in the current JM Commercial Roofing Product Manual.
4. Always start application at the low edge of the roof per the individual specification diagram.
5. Membrane can be installed when substrate and ambient temperatures are 20°F (-6.7°C) and above. Membrane can be adhered on the field without the use of additional VOC-containing adhesives. Heed the cold weather application procedures in **Cold Weather Installations** section below.

## Application

1. Lay and cut all membranes to the desired length, starting with the weldable selvage edge aligned with the low slope roof edge.
2. Align the weldable selvage edge with the lap line of the previously installed sheet.



3. Align the sheet ends of consecutive membranes. The end laps will be stripped with 8" JM TPO Reinforced Cover Strip at the end (see **Membrane Seaming** on next page).
4. Allow the membrane to relax 15-30 minutes (colder temperatures might require longer relaxation times).

5. Start adhering by folding the first membrane in half, along the length of the membrane, then peel the release liner at a 45 degree angle. Start with the membrane closer to the low slop roof-edge and with the weldable edge. Always step on the membrane surface to prevent contamination of the adhering surface. An electrostatic charge may develop when peeling the release liner. Keep all flammable materials away while peeling the release liner.



6. Lightly fluter the membrane and roll the exposed side down smoothing with your hands to promote adhesion. Watch for wrinkles in the material, adjust speed and tension as needed.

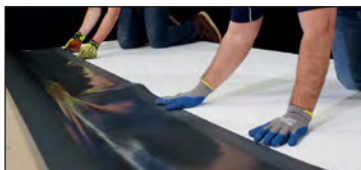

7. Repeat steps 5 and 6 on the other side of the membrane.



8. Broom in once both sides are down to promote adhesion and remove air pockets utilizing a stiff broom, starting from the middle out to the edges.



9. Roll-in the adhered membrane with 100lb split steel roller completely. Ensure the surface of the roller is clean and free of foreign material to prevent damage to the membrane.



10. Attached the membrane at parapet walls, penetrations and any angle changes using JM approved fasteners and plates. Install all appropriate flashings as necessary.



## General Instructions for Cold Weather TPO SA Installations

### (Below 40°F [4.5°C])

Roof applications utilizing TPO SA membranes between 40°F (4.5°C) to 20°F (-6.7°C) require special measures to ensure proper performance of the roofing system. JM requires that the following guidelines be followed:

Use extra care to ensure that any moisture is removed from the deck surface. The presence of moisture may cause poor adhesion or voids in the self-adhering membrane which in turn can entrap moisture within the roofing system.

- Membranes must maintain temperatures above 20°F (-6.7°C) all times during installation.
- **The use of primers is not required for membrane field installation. The use of SA Primer or SA LVOC Primer is required for flashing applications on curbs and parapet walls for temperatures below 40°F (4.5°C). Allow adequate primer flash dry times at these cold temperatures. Please refer to Section 3.4 for additional details.**
- Store SA Primer or SA LVOC Primer within 60°F to 80°F (16°C to 27°C) to protect product from freezing. Apply primer between 20°F and 100° F (-6.7°C and 38°C).
- Broom-in and roll-in the membrane thoroughly to ensure adhesion.
- Install only as much roofing material as can be completed and covered in one day.
- Thoroughly dry all weld surfaces prior to welding.
- Exercise caution when walking on dew, frost, ice or snow covered roofs since the membrane may be extremely slippery.
- The use of temporary roofs should be strongly considered if construction schedules require roof applications in cold or rainy weather.
- **Always comply with published safety procedures for all products being used. See the "Introduction" section of the current JM Commercial Roofing Product Manual, SDS & SIU and container labels for health and safety recommendations.**

### Membrane Seaming

Membrane Seaming for side laps is achieved by employing an approved automatic heat welder or hand held heat gun with a hand-held roller. Continuously weld a minimum 1½" (38.1 mm) wide seam following standard welding and inspection practices. End laps are seamed



by stripping with 8" JM TPO Reinforced Cover Strip following standard practices. [See Detail T-MS-11.](#)

### Membrane Flashings

(T-FW details): JM standard flashing and self-adhering (SA) flashing membranes can be used with TPO self-adhered roof installations. Refer to the paragraph below for specific instructions for self-adhering flashing membranes. Install all membrane flashings at the same time as the roof membrane. Do not use temporary flashings. If water penetrates the flashings, immediately replace all affected materials. Use only JM TPO SA, adhered or mechanically attached flashings or prefabricated flashings, depending on job circumstances. Follow standard recommendations and practices for adhered or mechanically attached flashings.

Terminate all JM Membrane flashings per the applicable detail. Reference details [T-FW-B1](#), [B2](#), [B3](#), [B4](#), [B5](#) and [B6](#) for approved base tie-in conditions.

### Self-adhering Membrane Flashings

Self-adhering Membrane Flashings can be installed directly to smooth approved substrates when substrate temperatures are 40°F (4.5°C) and rising. The use of

SA Primer or SA LVOC Primer is required for flashing applications on curbs and parapet walls for temperatures below 40°F (4.5°C).

Allow adequate primer flash dry times at these cold temperatures. Heed the cold weather application procedures on page 2-13 of this section.

- Approved smooth substrates are wood, APA OSB, SECURROCK® Gypsum-Fiber Roof Board, and Invinsa® Roof Board.
- All surfaces must be swept clean and free from oil, grease, rust, scale, loose paint and dirt.
- Prime smooth approved substrates with SA Primer or SA Primer LVOC when substrate temperatures are between 20°F and 40°F. Allow for primer to flash off, then apply the SA flashing membrane.
- For approved substrates with a porous and rough surface, including DensDeck® Prime, DensDeck®, and Concrete, prime with SA Primer or SA Primer LVOC prior to installation of flashing membrane.
- For approved substrates with a porous and rough surface, including DensDeck® Prime, DensDeck®, DEXcell®, concrete and smooth faced CMU, prime with SA Primer or SA Primer LVOC prior to installation of flashing membrane.
- Do not install JM TPO SA-Flashing Membrane in direct contact with asphalt.
- Refer to JM TPO applicator guides or detail drawings for instructions.

Secure adhered flashings to the parapet wall at 60" (152.4 cm) vertical intervals. Reference the [T-FW-I](#) Flashing Details. All adhered surfaces must be compatible with JM TPO roofing membranes. Extend all flashings a minimum of 8" (20.32 cm) above the roof level. Contact JM Technical Services for recommendations if this cannot be done.

Terminate all JM Membrane flashings per the applicable detail. Reference details [T-FW-B9](#), [B10](#), [B11](#) and [B12](#) for approved base tie-in conditions.

## Thermoplastic Olefin Self-Adhered Membrane (TPO SA)

- JM TPO SA membranes have a factory applied adhesive on the back side of the roofing membrane for self-adhering capabilities.
- JM TPO SA is available in 60 mil thickness and delivered in 10' (3.05 m) width for field application.
- JM TPO SA - Flashing membrane is available in 60 mil thickness of reinforced membrane, with weldable selvage edges on each side of the roll and delivered in 5' (1.52 m) width for curbs and parapet walls.
- Long-term Storage: TPO SA membrane should be stored between 60°F (16°C) and 90°F (32°C).
- Shelf-life: 12 months from manufacturing date, and based on standard storage conditions.

## Health and Safety

**JM develops and maintains Safety Data Sheets (SDS) and Safety Use Instructions (SUI) for all of its products. These SDS & SUI contain health and safety information for development of appropriate product handling procedures to protect the users of our products. These SDS & SUI are available on the JM Web site, [www.jm.com/roofing](http://www.jm.com/roofing) and should be read and understood by all involved personnel prior to using and handling JM materials. In addition to the SDS & SUI, JM products have health and safety precautions printed on the product label or packaging. The user is strongly urged to become familiar with this information prior to using the product, and observe certain precautions during use.**



## 6.0 TPO Membrane with Redundant Bituminous Ply Sheets (Hybrid Systems)

### Assembly Identification

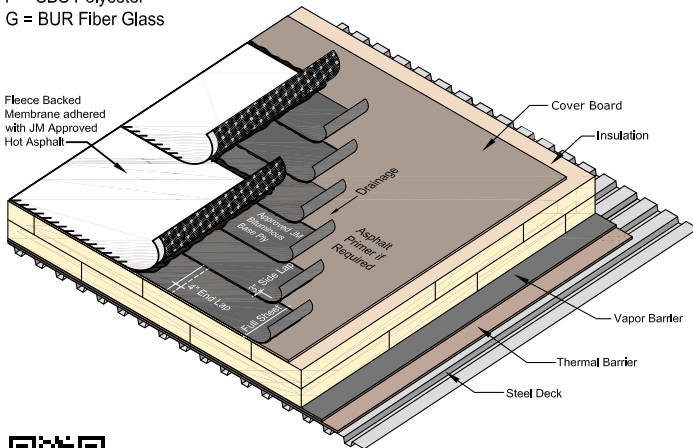
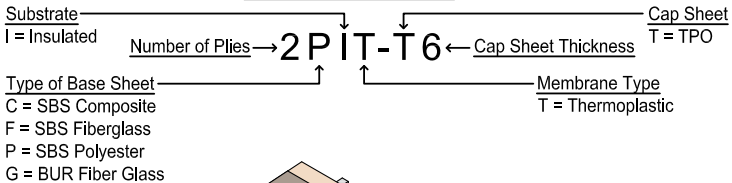

**NOTE:** For additional assembly plate variations, check out our interactive form online.

### General Information

The following section provides the application specifications currently available from Johns Manville (JM) for TPO fleece backed membranes with redundant built-up and SBS (Styrene-Butadiene-Styrene) modified bitumen plies for hot asphalt applications.

### Membrane Substrate

The surface on which the built-up, SBS modified bitumen, and/or TPO fleece backed roofing membrane is to be applied should be one of JM's roof insulations (Fesco®, Tapered Fesco®, Fesco® Foam, Tapered Fesco® Foam, ENRGY 3®, Tapered ENRGY 3®, or ½" [13 mm] Retro-Fit™ Board) or an approved structural substrate. The surface must be clean, smooth, flat and dry. (Built-up roofing and SBS modified bitumen should not be applied directly to foam plastic insulations, as referenced in the National Roofing Contractors Association [NRCA] Bulletin #9 of September 1988 and September 1998).

### TPO Membrane with Redundant Bituminous Systems Over Non-Nailable Decks

These specifications are for use over any type of structural deck which is not nailable and which offers a suitable surface to receive the roof. Poured and precast concrete require coating with JM Concrete Primer prior to the application of hot asphalt. Precast concrete panels also require a layer of approved roof insulation prior to installing a roof membrane.



These specifications are also for use over JM roof insulations (Fesco<sup>®</sup>, Tapered Fesco<sup>®</sup>, Fesco<sup>®</sup> Foam, Tapered Fesco<sup>®</sup> Foam, ENRGY 3<sup>®</sup>, Tapered ENRGY 3<sup>®</sup> and ½" [13 mm] Retro-Fit<sup>™</sup> Board) or other approved insulations that offer a suitable surface to receive the roof. These specifications are not to be used over lightweight insulating concrete decks or over a fill made of lightweight insulating concrete. Non-nailable specifications are denoted by an "I" as the third character in the specification designation (e.g., 4GIT).

## TPO Membrane with Redundant Bituminous Systems Over Nailable Decks

These specifications are for use over any type of structural deck (with or without insulation) which can receive and adequately retain nails or other types of mechanical fasteners recommended by the deck manufacturer. Examples of such decks are wood and plywood. Certain specifications are eligible for use over lightweight insulating concrete decks or over fill made of lightweight insulating concrete. Contact a JM Technical Services Specialist for approval of the light-weight fill to be used.

### General Guidelines for Application of Materials

5.1 The proper application of roofing materials is as important to the satisfactory performance of the roof membrane as the materials themselves. JM suggests the following guidelines for application of all roofing materials.

1. Don't use wet or damaged materials.
2. Never apply any roofing materials during rain or snow, or to wet surfaces. Moisture trapped within the roofing system as a result of this can cause severe damage to the roof membrane and insulation. Any product that has moisture contamination or is wet should be removed and discarded.
3. Review the guidelines for application of roofing, roof insulations, coatings and accessories shown in the current JM Commercial Roofing Product Manual.
4. Always start application at the low edge of the roof per the individual specification diagram.
5. Good roofing procedure restricts the application of hot asphalt to a maximum of 6' (1.83 m) in front of the roll.
6. When using mechanical felt laying equipment, be sure that all orifices are open.
7. All roofing ply felts should be well broomed into the hot asphalt utilizing a broom or some other device.
8. Take special care when applying BUR coated felts in cold weather. Check the temperature of the asphalt at the mop, asphalt spreader, and cart to determine that it is at the proper application temperature.
9. Roll or scroll SBS modified bitumen sheets into a full mopping of hot asphalt. Back mopping and flopping into a full coating of asphalt is also acceptable for certain SBS products. SBS base sheets with polyester reinforcement must be allowed to relax in an unrolled position prior to installation.
10. Roll out and cut all thermoplastic fleece backed membranes to specified lengths and allow them to relax.
11. Do not mix different grades of asphalt or dilute asphalt with any material.
12. Heat the asphalt according to the manufacturer's recommendations. Check the temperature of the asphalt at the kettle and at the point of application. Have accurate thermometers on all roofing kettles. Adhere to the guidelines for the heating of asphalts in this section of the manual.
13. Always install water cutoffs at the end of each day's work to prevent moisture infiltration into the completed work area. Water cut-offs should be completely removed prior to resuming work.
14. Heed the cold weather application procedures on page 2-22 of this section.

15. It is essential that traffic be minimized on a freshly laid roof, while the asphalt is still fluid. Asphaltic displacement through the porous fiber glass ply felts, SBS modified bitumen, and under the thermoplastic fleece backed membrane can result from rooftop traffic during asphalt "set" time. Depending on specific job factors, this set time can be as little as 45 minutes. Asphaltic displacement can result in "phantom" leaks and blistering of the membrane.
16. **Always comply with published safety procedures for all products being used. See the "Introduction" section of the current JM Commercial Roofing Product Manual, MSDS and container labels for health and safety recommendations.**

## Roofing Felts (Base and Ply Sheets)

JM manufactures different fiber glass roofing felts for a variety of roofing needs: vapor retarders, roof plies, base sheets and special felts for venting.

Roofing felts are furnished in rolls consisting of one or more squares. A "factory" square of roofing contains sufficient material to cover 100 ft<sup>2</sup> (9.29 m<sup>2</sup>) of roof surface accounting for nominal side and end laps.

For more information on these products, refer to Section 2 of the current JM Commercial Roofing Product Manual.

## TPO Fleece-Backed

JM TPO Fleece Backed for hot asphalt application has a 8oz polyester fleece for staining protection against the asphalt. The membrane is furnished in 60 and 80 mil thickness and delivered in 10' (3.05 m) widths. 60 mil membrane is 75' (22.86 m) long, and the 80 mil membrane is 50' (15.24m).

## Roofing Asphalts

JM BUR, SBS modified bitumen, and thermoplastic fleece back products are designed to be installed with hot asphalt (refer to the table on page 2-19).

PermaMop<sup>®</sup>, coal tar pitch and coal tar asphalt are not permitted.

Asphalt can come from a variety of crude sources. Many of these sources produce high-quality mopping grade asphalts and many do not. Various physical properties of asphalts can affect the performance of the roofing system. For this reason, JM qualifies asphalt sources throughout the country and requires that only these asphalts be used to assure good performance and compatibility with the roofing products being used.

JM requires the use of approved asphalt within systems which require a JM Peak Advantage<sup>®</sup> Guarantee. These approved asphalts are periodically tested to assure conformance to both ASTM and JM asphalt specifications. For the names of approved asphalt suppliers in your area, contact a JM sales representative.

## Health and Safety

See Section 1 of the JM Commercial Roofing Product Manual for health and safety information.

JM recommends the use of only two grades in BUR and SBS modified bitumen with thermoplastic fleece backed specifications — Type III and Type IV. The slope of the roof, as well as the climate, governs the grade of asphalt to be used. The success or failure of a roofing system depends greatly on the use of the proper grade of asphalt, as called for in the roofing specification.

## Heating

Asphalts are susceptible to damage from overheating. Overheating, even for short periods, can "crack" or degrade the asphalt (a drop in softening point and slight oiliness is a symptom). Fall back in softening point can result in slippage of felts in the roofing system. As the softening point decreases, the viscosity or "holding power" of the interply asphalt decreases, resulting in slippage. If the overheating is more gradual, the asphalt may "age" prematurely, losing the beneficial light oils that help

the roofing system weather and stay waterproof. Since asphalts are thermoplastic, their viscosity varies with temperature. Application temperature must be in the range which will permit an adequate film of asphalt, whether applied by mop or machine. The JM Technical Center, in conjunction with the National Roofing Contractors Association (NRCA) and the Asphalt Roofing Manufacturing Association (ARMA), has been involved in considerable research developing guidelines for the proper heating and application of hot asphalt. These guidelines use the principle of Equiviscous Temperature (EVT).

In conjunction with these guidelines, the following information is printed on the cartons of asphalt, or on the bill of lading for asphalt shipments.

1. The Softening Point as determined by ASTM D 312.
2. The Minimum Flash Point (FP) of the asphalt as determined by ASTM D 92.
3. The Equiviscous Temperature. As currently defined by ASTM, this is the temperature at which the asphalt viscosity is 125 centistokes. Asphalt applied within  $\pm 25^{\circ}\text{F}$  ( $\pm 14^{\circ}\text{C}$ ) of the EVT at the point of application will provide a nominal 23-25 pounds of asphalt per 100 ft<sup>2</sup> (1.12 - 1.22 kg/m<sup>2</sup>).
4. The Finished Blowing Temperature (FBT). This is the temperature at which the blowing of the asphalt is completed.

**NOTE:** Work done by NRCA has shown that different EVT values should be used for mop-applied asphalt and machine-applied asphalt. Mop applied asphalt should be applied at an EVT based on 125 centipoise, while machine-applied asphalt should be applied using an EVT based on 75 centipoise. ASTM is currently evaluating incorporating this information into its specifications. Some asphalt suppliers are now including both EVT values on their product. If only the 125 centipoise (centistokes) value is provided, then for machine application, the asphalt should be applied at a 25°F (14°C) higher temperature than the 125 centipoise values.

JM requires adherence to the following guidelines when the above information is furnished:

1. Use the proper softening point asphalt as specified for the roof slope, type of roofing system and climate.
2. For optimum application, the asphalt should be at the Equiviscous Temperature,  $\pm 25^{\circ}\text{F}$  ( $\pm 14^{\circ}\text{C}$ ), at the point of application. **However, SBS modified bitumen products require installation in asphalt with a minimum temperature of 400°F (204°C) at point of application.**
3. Never heat the asphalt to or above the Flash Point, to avoid danger of fire.
4. Heating above the Finished Blowing Temperature shall be strictly regulated, never for longer than four hours to preclude excessive asphalt degradation.

The characteristics per ASTM D 312 of the various grades of asphalt are as follows:

Product	ASTM Type	Softening Point		Flash Point
		Min.	Max.	C.O.C.** Min.
140°F (60°C) (dead level)	I	135°F (57°C)	151°F (66°C)	475°F (246°C)
170°F (77°C) (flat)	II	158°F (70°C)	176°F (80°C)	475°F (246°C)
190°F (88°C) (steep)	III	185°F (85°C)	205°F (96°C)	475°F (246°C)
220°F (104°C) (special steep)	IV	210°F (99°C)	225°F (107°C)	475°F (246°C)

\*\* Cleveland Open Cup Method.

### Penetration (dmm)

Product	32°F (0°C) 60 Sec. 200g.		77°F (25°C) 5 Sec. 100g.		115°F (46°C) @ 5 Sec. 77°F 50g.		Ductility (25°C) 5 cm/Min.
	Min.	Max.	Min.	Max.	Min.	Max.	
140°F (60°C)	3	—	18	60	90	180	10.0
170°F (77°C)	6	—	18	40	—	100	3.0
190°F (88°C)	6	—	15	35	—	90	2.5
220°F (104°C)	6	—	12	25	—	75	1.5

If Equiviscous Temperature is not available, nominal heating temperature guidelines of the asphalt are as follows:

### Recommended Temperatures

Asphalt Type	Heating	Application for BUR
140°F (60°C)	425°F (218°C)	335°F to 405°F (168°C to 207°C)
170°F (77°C)	450°F (232°C)	350°F to 415°F (177°C to 213°C)
190°F (88°C)	500°F (260°C)	365°F to 435°F (185°C to 224°C)
220°F (104°C)	500°F (260°C)	400°F to 475°F (204°C to 246°C)

Use of insulated buckets, high boys, and circulating lines for cold weather application can help maintain a proper EVT when temperatures are low and the distance from the asphalt source to the point of application is great.

When asphalts are applied within the EVT temperature ranges, the proper amount of asphalt will be placed between the plies. The recommended quantity of asphalt has been indicated on each specification in the current JM Commercial Roofing Product Manual. Regardless of the exact quantity of asphalt applied, it is important that the asphalt be continuous, so felt does not touch felt, and that there be full adhesion between all plies of the system. JM considers a  $\pm 25\%$  deviation from the asphalt quantity of 22 pounds per square listed to be acceptable.

## Hot Asphalt Application

The BUR and SBS Modified Bitumen sheets must be firmly and uniformly placed in a full mopping of hot asphalt, without voids, and with all edges well sealed.

The thermoplastic fleece backed membrane must be firmly and uniformly placed in a full mopping of hot asphalt, without voids. **Asphalt must not be applied to the selvage edges of the thermoplastic fleece back membrane to allow a minimum 1.5" (38.1 mm) weld.** If the weld is not 1.5" (38.1 mm), then the entire seam must be stripped-in using a detail strip.

## Mop-Applied Asphalt

There are several application techniques that can be used when the asphalt is installed by mopping. The modified bitumen sheet can be rolled, scrolled or flopped into the asphalt. Regardless of the application technique employed, the crucial factor is that the SBS modified bitumen sheets and thermoplastic fleece backed membrane make complete contact and embed in the hot asphalt. This can be accomplished by lightly brooming the modified bitumen sheet immediately after it has been

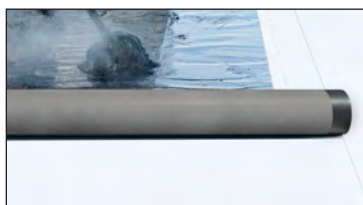

installed. It is also good roofing practice to “scuff in” the side and end laps to assure that they are completely sealed.

## Rolling Technique

When rolling the modified bitumen sheet or the thermoplastic fleece backed membrane into the asphalt, the mechanic should mop no more than 6' (1.83 m) in front of the roll to ensure that the temperature of the asphalt does not cool and fall below the temperature necessary for good embedment. If the asphalt is allowed to cool too much, an inadequate bond may result. In addition, the viscosity of the asphalt increases, which can result in a wavy appearance or excessive quantities of asphalt. Excessive asphalt can increase the potential for slippage of the membrane. When using this application technique, brooming of the modified bitumen sheet and thermoplastic fleece backed membrane is especially important at the end of the sheet where there may not be sufficient weight from the roll to provide the necessary pressure to embed the sheet into the asphalt. Thermoplastic fleece backed roll is aligned and installed using typical hot asphalt technique.

## Scrolling Technique

The scrolling technique is also used by many roofing mechanics. This technique was originally used to allow the modified bitumen and thermoplastic fleece backed sheets to relax. Although this is not required with fiber glass and fiber glass/polyester composite-reinforced SBS modified bitumen products, this method is occasionally used. The modified bitumen roll is completely unwound, usually turned upside down, and allowed to “relax.” After the sheet has warmed, it is then turned right-side-up, placed on the roof in the area where it is to be installed and rerolled or scrolled from both ends. The product is then mopped into place using the same mopping techniques and precautions described for rolling the product into place. The Thermoplastic fleece-backed roll is then aligned and installed using the typical hot asphalt technique.

## Mechanically Applied Asphalt

The asphalt can be applied using a mechanical asphalt spreader, which can increase productivity. Some contractors have found that installing the material with a felt layer can also improve production.

## Heat Welding Thermoplastic Fleece Backed Seams

This section describes welding and fastening methods used to install JM TPO roofing systems. Included: hot-air welding membrane sections, prefabricated JM TPO Coated Metal parts, and asphalt application of the membrane.

Before welding, ensure area is clean and dry. Remove dirt or contamination before welding by using low sudsing soap and water followed by membrane cleaner, or just membrane cleaner. As a last resort, cut away the affected sheet section and replace with new material. Hot air welding equipment is required to make all field seams. Welding speeds will be slower in high humidity conditions or at low temperatures.

Hot air welding works by applying very hot air to the membrane surfaces, softening and fusing the surfaces together, thereby creating a permanently fused, bonded sheet. One of the major advantages of hot air welding is the fact that the seam comes to full weld strength immediately.

Membranes can be hot air welded in many different conditions, including cold weather. A hand-held hot air welder is especially useful when welding membrane sections at corners or on vertical surfaces. Hand-held hot air welders are also used to weld membrane sections together or to weld membrane to JM TPO Coated Metal, which has factory-laminated TPO membrane on its top side and a protective coating on the back.

With either method, perform a test weld before beginning each day's application and any time the hot air welder has been turned off for any length of time to check

peel strength, consistency, weld width, etc. and to adjust the welder. First, adjust the temperature of the hot air welder to produce a shiny membrane surface without burning the membrane. Fully insert the nozzle tip of the hot air welder into the seam, moving it slowly backwards. As the membrane softens, press the membrane surfaces together with a silicone rubber roller from the inside edge to the outside edge of the seam. Take care to produce a continuous weld with no air pockets.

If the membrane surface is overheated, a good weld cannot be achieved. The burned or discolored membrane must be patched. To repair a burned section, cut away the damaged material at least 1" (2.54 cm) beyond the burned edges. Patches should be cut to extend at least 3" (7.62 cm) beyond all damaged edges. Allow for a minimum 1½" (3.81 cm) weld width on all sides. Center the patch over the cut area and weld to the membrane, using normal welding procedures. Cut all patches in a square or rectangular shape with round corners for a neat, finished roof appearance.

The t-joint occurs where three layers of membrane overlap. Voids may occur along the edge of the middle layer of membrane. To close the void, gently lift the upper membrane sheet and apply sufficient hot air to heat the membrane surfaces. Then, using the edge of a silicone rubber roller, roll and fuse the upper membrane surface into the lower membrane. A crease developed along the intersection of the two surfaces indicates a proper weld. JM recommends patching all t-joints – to include base flashing – using a JM TPO T-Joint Patch.

Hot air welded seams may be tested as soon as the seams cool. After welding, carefully test every seam and t-joint along its entire length. Do this by running a blunted scratch awl, cotter key puller, or other round-tipped blunted tool along the seam edge while applying firm, steady pressure. It is imperative to avoid scoring the membrane that has just been welded. Any penetration of the probe into the seam indicates a void in the weld which must be repaired.

Continuous seam probing will tend to sharpen the tip of the probe, so it is important to blunt the tip of the probe regularly. Test all welded seams for integrity and continuity before the end of each work day. In addition to probing, take seam samples to verify seam quality as necessary. Cut the samples across the seam 6" (15.24 cm) on each side of the seam and 2" (5.08 cm) wide. Peel these samples by hand to test seam strength. Good seams will be virtually impossible to peel and should delaminate the TPO film from the reinforcing scrim. Cut and test a minimum of one sample in the morning and when weather conditions change or after work interruptions when the automatic hot air welder has been shut off.

## Cold Weather Application (Below 45°F [7°C])

### General Instructions for Cold Weather Bituminous Installations

Roof applications utilizing asphalt below 45°F (7°C) require special measures to ensure proper performance of the roofing system. JM strongly recommends that the following guidelines be followed when applying built-up or SBS Modified bitumen roofing systems in cold weather:

1. Use extra care to ensure that any moisture is removed from the deck surface. The presence of moisture may cause poor adhesion or skips in the mopping asphalt which in turn can entrap moisture within the roofing system.
2. Store materials in a heated warehouse or closed and heated trailer immediately prior to installing.

3. Do not overheat the asphalt. Insulated asphalt lines and insulated rooftop equipment should be used. Set up job site equipment to minimize the distance between asphalt heating source and application point.
4. Do not mop more than 4' (1.22 m) ahead of the roll. Embed the rolls into the hot asphalt immediately.
5. Squeegee all fiber glass ply felts to ensure adhesion.
6. Install only as much roofing material as can be completed and covered in one day.
7. The use of temporary roofs should be strongly considered if construction schedules require roof applications in cold or rainy weather.

## General Suggestions for Cold Weather TPO Fleece Backed Installation

1. Store all JM TPO materials in warm, dry area away from sparks and open flames, to avoid condensation problems which could affect weld quality.
2. Take at least twice the usual number of seam samples to test for peel resistance since the possibility of inferior welds is greater.
3. Thoroughly dry all weld surfaces prior to welding.
4. Exercise caution when walking on dew, frost, ice or snow covered roofs since the membrane may be extremely slippery.

## 7.0 Seaming, T-Joints, Penetrations, and Other Considerations

### Membrane Seaming Methods

#### Before Welding

Visually inspect all hot air welders, both hand-held and robotic, for damage, loose parts or screws, and cleanliness. Check drive wheel and drive belt, pressure wheel, rear guide wheel, and all other mechanical parts. Motion testing of the robotic welder to ensure it is tracking straight should also be done before welder is used for membrane seaming.

Ensure you have a clean consistent power source for your hot air welders. Generators should not be used to power other tools when hot air welders are in use. The surging created by other power tools cycling on and off can cause inconsistencies in the final welded product. Often times a job site/facility power source is preferred. However, it is recommended that extension cord length does not exceed 100', which means generators may be required on some job sites.

Cut pieces of membrane to create test welds to ensure the settings of the robotic and hand-held welders are correctly configured to the current membrane and environmental conditions. Perform a 4' or 5' (1.22 m or 1.52 m) test weld before beginning each day's application and any time the hot air welder has been turned off for any length of time, to check peel strength, consistency, weld width, etc. Adjust the welder accordingly.

Make sure the membrane is clean and dry on both sides of the membrane to be welded. If dirt and/or contaminants are not removed by wiping membrane with a clean dry cotton cloth, JM Single Ply Membrane Cleaner may be used. If cleaner is used, give an appropriate amount of time for the solvents to completely flash off, approximately 5 minutes.



## Hand-Held Hot Air Welding

After verifying the areas to be welded are clean and dry, seams are aligned with the minimum required overlap, and the welding equipment is set to the calibrated temperature setting; welding of the seam or flashing may begin.

1. Lift the top layer of membrane to insert the nozzle of the hand-held welder underneath with the end of the nozzle at a 45° angle to the seam.
2. Apply pressure with the 2" rubber/silicone roller, moving back and forth, parallel to the end of the nozzle, extending ½" past the nozzle in each direction.
3. Follow the hand-held hot air welder approximately ¼" – ½" behind the nozzle end as you continue down the weld in a smooth and consistent movement.



If you must stop in the middle of a weld for any reason make sure to pull on the last section of weld to release any cold or false welds. Then insert the nozzle back into the weld and continue as described above.

## Robotic Hot Air Welding

Robotic hot air welders provide many performance advantages over hand-held hot air welders but their larger size and directionality do not make them applicable in all situations. Several advantages are consistent speed of weld, constant pressure on welded area, higher powered heating element, built-in air damn, and



repeatability. Field seams must be completed by a robotic hot air welder.

JM TPO in standard conditions (70°F and 50% humidity) responds well to settings of 1050°F and 10.5' per minute.

After verifying the areas to be welded are clean and dry, seams are aligned with the minimum required overlap, and the welding equipment is set to the calibrated temperature setting; welding of the seam or flashing may begin.

To begin the welding process, align the drive wheel of the welder onto the edge of the top layer of membrane, move the rear guide wheel onto the same edge of the top layer of membrane, and insert the 2" nozzle into the lap to be welded. Fully seating the nozzle in the lap should activate the automatic movement function of the robotic hot air welder.

**NOTE: Use caution as the robotic hot air welder's direction of movement usually is in the backward walking direction for the operator. The assistance of a spotter and cord person is recommended.**

Surface irregularities can cause the pressure wheel to move slightly away from the seam. If this happens, apply light pressure on the machine's upper handle to maintain travel in a straight line and keep even pressure of the drive wheel on the welded seam area. As the hot air nozzle moves along the weld area, the wide drive wheel behind the nozzle (relative to the direction of movement) applies immediate and uniform pressure to the heated seam area. Check all robotic hot air welded seams for voids and repair with a hand-held hot air welder before the end of each working day.



## T-Joints

T-joints occur where three layers of membrane intersect. Voids may occur along the edge of the middle layer of membrane between the upper and lower layers of membrane. After the lower and middle layer of membrane have been welded:



### In the case of hand welding:

1. To seal the void, gently lift the upper membrane sheet and apply sufficient hot air to heat both membrane surfaces.
2. Then, using the edge of a silicone rubber roller, roll and fuse the upper membrane surface into the lower membrane. A crease developed along the intersection of the two surfaces indicates a proper weld.

### In the case of robotic welding:

1. To seal the void, when the robotic welder passes over the T-joint and the pressure wheel clears, use the edge of a silicone rubber roller to roll and fuse the upper membrane surface into the lower membrane. A crease developed along the intersection of the two surfaces indicates a proper weld.

**Applying heat to the top side of the upper membrane sheet will not effectively fuse the two membranes together and will only damage the upper membrane sheet. JM recommends patching all t-joints — including base flashing — using a 4.5" (11.43 cm) rounded piece of detail membrane or JM TPO T-Joint Patch.**

## Repairing Scorched Membranes

If a section of the membrane surface is overheated, the burned or discolored membrane must be patched, as a good weld cannot be achieved.

1. To repair a scorched section, cut a patch in a square or rectangular shape with rounded corners. Patches should be cut to extend at least 3" (7.62 cm) beyond all damaged area. Allowing for a minimum 1.5" (3.81 cm) weld width on all sides.
2. Center the patch over the cut area and weld to the membrane, using normal hand-held hot air welder procedures.

Reinforced membrane is to be used for patches on field membrane; non-reinforced membrane is to be utilized at areas requiring a tight contour or change in direction.

## Probing Seams

Test all welded seams for integrity and continuity before the end of each work day.

Hot air welded seams may be tested as soon as the seams cool, testing prior to the cooling of the seam will cause damage to the membrane and the weld.

After the weld has cooled, carefully test every seam, t-joint, and patch along its entire length. Do this by running a blunted scratch awl, cotter key extractor or other round-tipped, blunted tool along the seam edge while applying firm, steady horizontal pressure. It is imperative to avoid scoring the membrane that has just been welded. Any penetration of the probe into the seam indicates a void in the weld, which must be repaired. Continuous seam probing will tend to sharpen the tip of the probe, so it is important to blunt the tip of the probe regularly.



## Testing Seams

In addition to probing, take seam samples to verify seam quality as necessary.

Cut the samples across the seam 6" (15.24 cm) on each side of the seam and 2" (5.08 cm) wide. Peel these samples by hand to test seam strength. Good seams will be virtually impossible to peel, and should delaminate the TPO film from the reinforcing scrim. Cut and test a minimum of three seam samples each day — in the morning, at mid-day, and at day's end. Take additional test cuts when weather conditions change or after work interruptions when the automatic hot air welder has been shut off.

## Sealing Tested Seams

Seal all cut seam edges with JM TPO Edge Sealant after testing and repairing. This prevents water from entering the welded area through wicking or capillary action. Weld and seal seams at all cut edges on the same day. Clean and dry any edges that stand overnight to ensure good sealant adhesion. Apply sealant with a squeeze bottle. Draw the tip smoothly along the cut edge of the membrane to produce a uniform 1/8" (3.18 mm) bead.

## Flashings and Penetrations

### Drains

There are several methods for flashing drains with JM TPO roofing membrane. The most common method is to taper insulation to the drain bowl creating a sump. A proper sump is created by using tapered panels, not shaving the edge of the insulation board around the drain..

1. Apply one tube of JM Single Ply Sealing Mastic around the drain bowl. Cut JM TPO Flashing Membrane to overlay drain area, and cut out hole in center area at least the same diameter as the drain leader. Cut holes one-half the size of bolt diameter at drain bolt penetrations. **Make sure there are no seams or fasteners through the drain clamping ring. Ideally, there should be no seams or fasteners in the drain sump. Add target patch if necessary.**
2. Carefully press membrane drain flashing over drain bowl area and work into the mastic to form seal. Place metal clamping ring over membrane flashing so that bolt holes line up, and then tighten the bolts [See detail T-DV-07](#). Do not run fleece back membrane into the drain bowl. [See detail T-DV-09](#). The drain flashing membrane shall not be installed under tension or showing signs of ridging or deformation.

### Vent Pipes

There are two primary methods for installing vent pipes in JM TPO roofing systems:

#### Method A. Installing Prefabricated Vent Pipe Boots:

[See Detail T-FP-01](#) JM TPO Pipe Boots are available to accommodate various diameters for installation over pipes. They are available with a peel-and-stick adhesive or in a heat-weldable style.

Prior to pipe boot installation, remove any asphaltic deposits from vent pipes. Completely wrap any remaining asphalt with aluminum tape before plastic boot comes into contact with pipe. Bring the JM TPO field sheet up to the base of the pipe and fasten or secure with a minimum of four fasteners around the vent stack. If using the peel-and-stick pipe boot, first prime the field area, then place the boot over the pipe and remove the peel-and-stick tape then roll with a silicone roller to make sufficient contact. If using the prefabricated pipe boot, place the boot over the pipe and weld continuously around the bottom lip of the boot. Ensure that pipe boot extends past outside edge of all fasteners by a minimum 1/2" (3.81 cm).

Apply JM Single Ply Sealing Mastic behind the top of the pipe boot membrane before pulling draw band tight around the vent pipe. Apply JM Single Ply Caulk to the top of the draw band to seal against water intrusion.

See details [T-FP-04](#), [T-FP-05](#), and [T-FP-06](#) for pre-fabricated split pipe boots.

## Method B, Sealing Pipe Base with JM TPO Flashing: [See Detail T-FP-07](#)

1. Prepare a square JM TPO Detail Membrane target patch to overlap the securement plate edges by at least 4" (10.16 cm), to accommodate sheet movement and a 1½" (3.81 cm) weld width. Round off all corners. Cut a hole in the center of the membrane that is about two-thirds of the diameter of the pipe. Center hole over the pipe; heat area around the hole with a heat welder, and stretch fit membrane over the pipe to create a 1" (2.54 cm) turn-up, with the collar seated flush on the deck.
2. Weld the membrane collar continuously to the field sheet and/or the metal collar. Field wrap JM TPO Detail Membrane around the pipe stand and adhere to the vent pipe, while flanging the bottom of the field wrap. Extend field wrap flange at least 1" (2.54 cm) onto the membrane stretch collar and weld continuously to the collar. If the pipe has asphalt or other contaminants on it, it must be cleaned and wrapped completely with aluminum tape before installing the flashing.

## Penetration Pockets

Penetration pockets are used to seal around irregular shaped penetrations through the roofing system that do not allow for previously mentioned flashing methods.



[See Detail T-FP-02](#) JM Penetration Pockets are two-piece molded pockets with a rigid vertical wall and preformed flange. Field-fabricated penetration pockets are also available, typically fabricated from JM TPO-Coated Metal. [See Detail T-FP-03.](#)

Leave an open, overlapped seam at the center of one side so the penetration pocket may be spread around penetrations before final riveting. Minimum Field Fabricated TPO Clad penetration pocket height is 4" (10.16 cm).

Fasten penetration pocket flanges at the outside to the deck or nailer. The overlap or opening must be covered with aluminum tape and detail membrane prior to stripping flange. With strips of JM TPO Detail Membrane, strip in penetration pocket around all four sides, and weld continuously to JM TPO-Coated Metal as you would a field sheet. Seal all cut edges with JM TPO Edge Sealant. JM TPO Primer must be applied to the inside surfaces of the JM penetration pocket or fabricated pitch pan.

Using JM TPO Pourable Sealer, fill until mounded above penetration pocket and slope from pipe to penetration pocket edges to shed water (no ponding water should be present in penetration pocket). Fasten penetration pockets greater than 18" x 18" (45.72 cm x 45.72 cm) to nailers securely anchored to the deck.

## JM TPO-Coated Metal Flashing

[Reference details T-FE-CM for coated metal perimeter edge flashings.](#) Preformed JM TPO-Coated Metal Flashing is fastened around the roof perimeter edge. Welding the membrane to JM TPO-Coated Metal Flashings at these points provides a watertight seal.

JM TPO-Coated Metal Flashing is manufactured in 10' (3.05 m) lengths. Leave a ¾" to ½" (9.53 mm to 1.27 cm) maximum gap between each length to allow for thermal expansion. Aluminum tape should be applied over all joints in JM TPO-Coated Metal prior to heat welding the joint covers and membrane in place.

[Reference detail T-FE-CM6.](#)

## Gravel Stops and Drip Edge

[Reference T-FE-CM1 for drip edge,](#) and [T-FE-CM3 for gravel stop.](#) The top of the gravel stop must be at least 1½" (3.81 cm) above the nailer height. This may vary, depending on roof conditions. The bottom edge of the flashing should extend at least 1" (2.54 cm) below the nailer on the vertical fascia surface.

If the vertical gravel stop face exceeds 4" (10.16 cm), fasten per the job specifications, but not less than a 20-gauge to 24-gauge (0.91 mm to 0.61 mm), continuous galvanized steel clip on the fascia.

Use lengths of gravel stop to quickly position each cleat. Fasten the gravel stop to the wood nailer with roofing nails spaced 6" (15.24 cm) o.c. and staggered. Leave a  $\frac{3}{8}$ " to  $\frac{1}{2}$ " (9.53 mm to 12.7 mm) gap for expansion between gravel stop lengths. Apply aluminum tape to the joint prior to heat welding the joint covers and membrane in place.

## Membrane Flashings

Install all membrane flashings at the same time as the roof membrane. Do not use temporary flashings. If water penetrates the flashings, immediately replace all affected materials.

Use only JM TPO adhered, mechanically attached, or prefabricated flashings, depending on job circumstances. Secure the mechanically attached flashings to the parapet wall at a maximum vertical distance of 18" (45.72 cm) o.c., and horizontally to the parapet at maximum spacing of 12" (30.48 cm) o.c. Reference detail [See detail T-FW-B8](#). All adhered surfaces must be compatible with JM TPO roofing membranes. [See detail T-FW-M11](#) to view which substrates are compatible. If existing asphalt flashing remains, then  $\frac{1}{4}$ " Invinsa<sup>®</sup>,  $1\frac{5}{32}$ " (1.91 cm) thick plywood,  $\frac{5}{16}$ " (1.43 cm) OSB, or 9 oz./yd<sup>2</sup> (0.31 kg/m<sup>2</sup>) polyester fleece must be secured to the asphaltic surface as a barrier before applying JM TPO Membrane Flashings.

**Paper slip sheets are not acceptable for use as asphalt barriers.** Apply adhesive as noted in "Adhered Systems" in section 4.0 of this guide. **Do not apply adhesive to any flashing areas that will be welded.**

**Do not use fleece back membrane for flashings. One-sided water-based adhesive applications are not approved for vertical surfaces.**

Extend all flashings a minimum of 8" (20.32 cm) above the roof level. Contact your JM Technical Services Specialist for recommendations if this cannot be done. Terminate all JM TPO Membrane Flashings per the applicable detail.

## Walkpads

If pavers are used as permanent walkways for maintaining rooftop equipment, use an additional layer of JM TPO Membrane or a layer of JM 9 oz./yd<sup>2</sup> (0.31 kg/m<sup>2</sup>) Polyester Mat Protection Slipsheet under paver blocks to protect the membrane.

Another walkway option on a mechanically fastened or adhered roof is to weld strips of JM TPO Walkpad or Heavy-Duty Walkpad material directly to the membrane. [See details T-PT-05, 06, & 07](#) and note that walkpads **must not be installed over field seams**. This material provides an almost continuous walkway, and is embossed for a skid-resistant surface. JM TPO Walkpad should be continuously welded to the membrane and checked for voids, which must be repaired with a heat welder. Continuously welding the walkway material will seal against water entry.

**Adhered systems require walkpads to also be adhered.**

## Night Tie-Off

Apply water cutoffs to seal the edge of roofing layers at the end of the work day. If a cutoff is required on an existing gravel-surfaced roof, completely spud off the gravel for a watertight connection.

If JM TPO Membrane has been exposed for a period greater than 24 hours and/or compromised by dirt or debris, the area shall be removed or cleaned with JM Single Ply Membrane Cleaner prior to welding to ensure full weld strength.

# 3

## **JM TPO Mechanically Fastened Membrane Fastening Patterns**



**Section Three:  
JM TPO Mechanically Fastened  
Membrane Fastening Patterns**

# 3

## **JM TPO Mechanically Fastened Membrane Fastening Patterns**

## Mechanically Attached JM TPO - 6" O.C. (Using Perimeter Sheets)

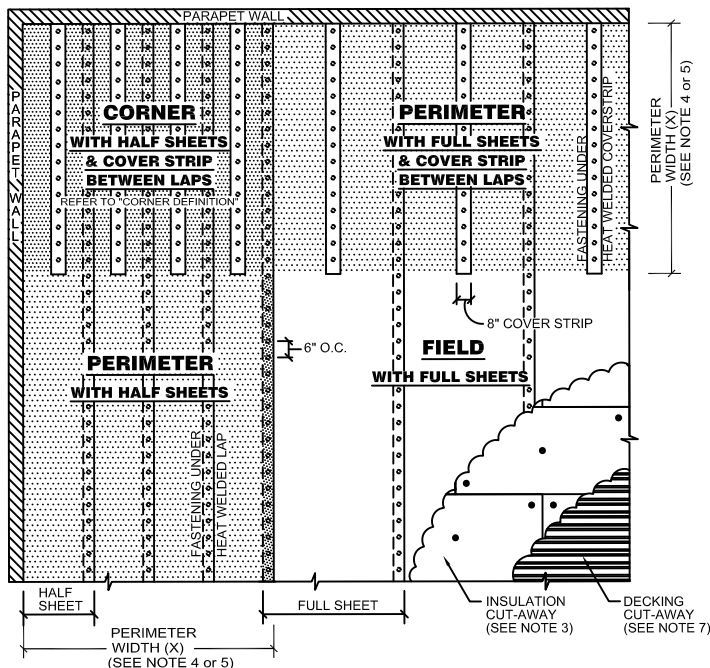

### NOTES

- CALCULATE UPLIFT DESIGN PRESSURES IN ACCORDANCE WITH ASCE-7.
- FASTENING DIAGRAM IS BASED ON FM GLOBAL DATA SHEET 1-29.
- INSTALL INSULATION WITH LONG JOINTS IN A CONTINUOUS STRAIGHT LINE WITH END JOINTS STAGGERED.
- ROOF HEIGHT  $\leq 60$  FT , THE PERIMETER (X) IS THE SMALLER DIMENSION OF:  
10% OF THE SHORTEST SIDE (PLAN VIEW)  
OR  
40% OF THE ROOF HEIGHT,  
BUT  
NOT LESS THAN 4% OF THE SHORTEST SIDE (PLAN VIEW) OR 3 FEET.
- ROOF HEIGHT  $> 60$  FT , THE PERIMETER (X) IS:  
10% OF THE SHORTEST SIDE (PLAN VIEW) BUT NOT LESS THAN 3 FEET.
- THE CORNERS MAY BE TREATED AS PERIMETERS IF THE PARAPET IS GREATER THAN OR EQUAL TO 3 FT ON ALL SIDES ACCORDING TO ASCE-7.
- MEMBRANE SIDE LAPS MUST RUN PERPENDICULAR TO METAL DECK FLUTES.

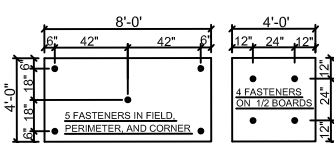

**INSULATION FASTENING**

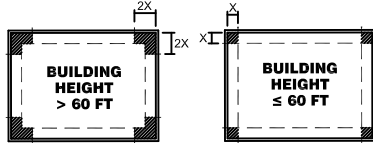

(SEE NOTES 4, 5 & 6)  
**CORNER DEFINITION**

Johns Manville is a manufacturer of commercial roofing products and offers this general conceptual information to you as a courtesy. This complimentary assistance is not to be used or relied upon by anyone as a substitute for professional engineering design and documentation required by building code, contract, or applicable law. By accepting these comments you agree they do not constitute any representations, endorsements of, or an assumption by Johns Manville of any liability for either the adequacy of design of this building or any other material not supplied by Johns Manville.

**Note:** For the most current information on general guidelines, please refer to the System Considerations tab under Commercial Roofing Products on the JM Roofing Web site. For specifications, flashing details and general installation information please refer to the Application Tools tab.

Refer to the Safe Use Instructions and product label prior to using this product.

## Mechanically Attached JM TPO - 6" O.C. (Using Cover Strips)

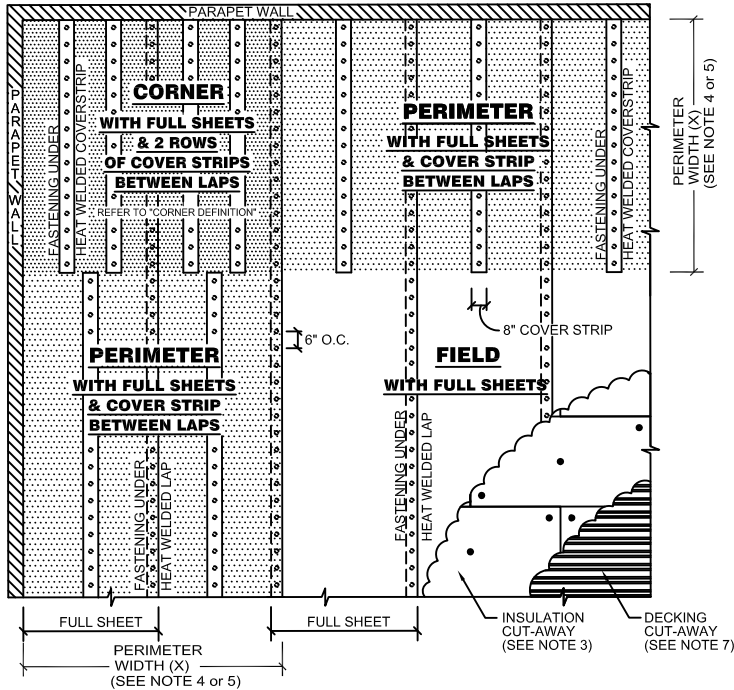

### NOTES

- CALCULATE UPLIFT DESIGN PRESSURES IN ACCORDANCE WITH ASCE-7.
- FASTENING DIAGRAM IS BASED ON FM GLOBAL DATA SHEET 1-29.
- INSTALL INSULATION WITH LONG JOINTS IN A CONTINUOUS STRAIGHT LINE WITH END JOINTS STAGGERED.
- ROOF HEIGHT  $\leq 60$  FT THE PERIMETER (X) IS THE SMALLER DIMENSION OF:  
10% OF THE SHORTEST SIDE (PLAN VIEW)  
OR  
40% OF THE ROOF HEIGHT,  
BUT  
NOT LESS THAN 4% OF THE SHORTEST SIDE (PLAN VIEW) OR 3 FEET.
- ROOF HEIGHT  $> 60$  FT THE PERIMETER (X) IS:  
10% OF THE SHORTEST SIDE (PLAN VIEW) BUT NOT LESS THAN 3 FEET.
- THE CORNERS MAY BE TREATED AS PERIMETERS IF THE PARAPET IS GREATER THAN OR EQUAL TO 3 FT ON ALL SIDES ACCORDING TO ASCE-7.
- MEMBRANE SIDE LAPS MUST RUN PERPENDICULAR TO METAL DECK FLUTES.

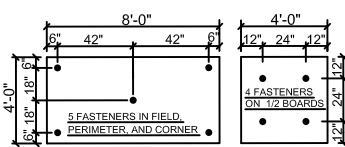

**INSULATION FASTENING**

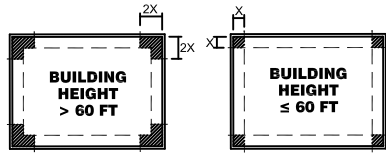

(SEE NOTES 4, 5 & 6)

**CORNER DEFINITION**

Johns Manville is a manufacturer of commercial roofing products and offers this general conceptual information to you as a courtesy. This complimentary assistance is not to be used or relied upon by anyone as a substitute for professional engineering design and documentation required by building code, contract, or applicable law. By accepting these comments you agree they do not constitute any representations, endorsements of, or an assumption by Johns Manville of any liability for either the adequacy of design of this building or any other material not supplied by Johns Manville.

**Note:** For the most current information on general guidelines, please refer to the System Considerations tab under Commercial Roofing Products on the JM Roofing Web site. For specifications, flashing details and general installation information please refer to the Application Tools tab.

Refer to the Safe Use Instructions and product label prior to using this product.



## Mechanically Fastened JM TPO - 6" O.C. (Using 10" RPS)

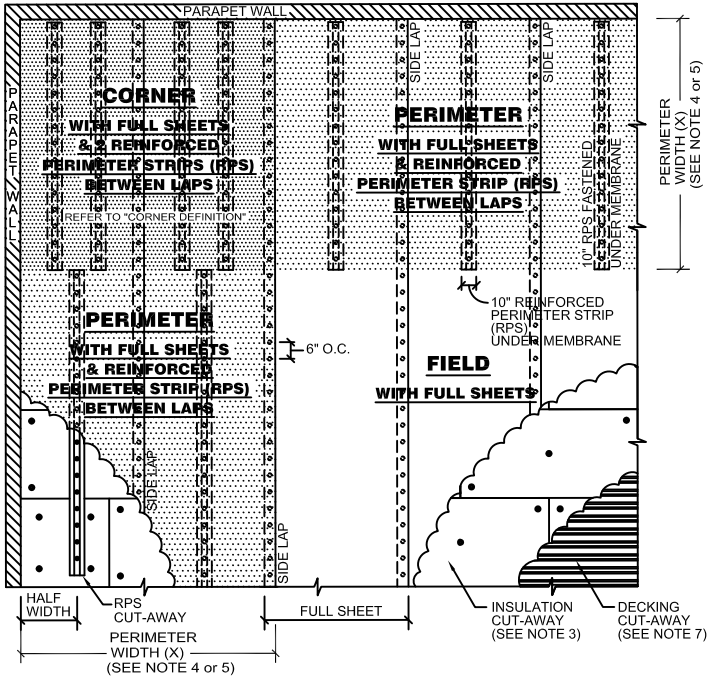

### NOTES

- CALCULATE UPLIFT DESIGN PRESSURES IN ACCORDANCE WITH ASCE-7.
- FASTENING DIAGRAM IS BASED ON FM GLOBAL DATA SHEET 1-29.
- INSTALL INSULATION WITH LONG JOINTS IN A CONTINUOUS STRAIGHT LINE WITH END JOINTS STAGGERED.
- ROOF HEIGHT  $\leq 60$  FT , THE PERIMETER (X) IS THE SMALLER DIMENSION OF:  
10% OF THE SHORTEST SIDE (PLAN VIEW)  
OR  
40% OF THE ROOF HEIGHT,  
BUT  
NOT LESS THAN 4% OF THE SHORTEST SIDE (PLAN VIEW) OR 3 FEET.
- ROOF HEIGHT  $> 60$  FT , THE PERIMETER (X) IS:  
10% OF THE SHORTEST SIDE (PLAN VIEW) BUT NOT LESS THAN 3 FEET.
- THE CORNERS MAY BE TREATED AS PERIMETERS IF THE PARAPET IS GREATER THAN OR EQUAL TO 3 FT ON ALL SIDES ACCORDING TO ASCE-7.
- MEMBRANE SIDE LAPS MUST RUN PERPENDICULAR TO METAL DECK FLUTES.

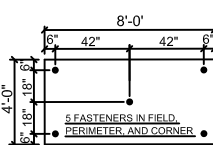

**INSULATION FASTENING**

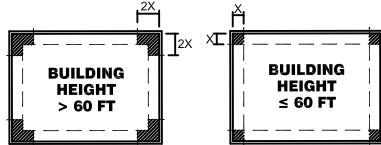
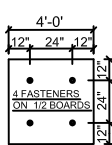

(SEE NOTES 4, 5 & 6)

**CORNER DEFINITION**

TPO Mechanically Fastened Membrane  
Fastening Patterns  
SECTION THREE

Johns Manville is a manufacturer of commercial roofing products and offers this general conceptual information to you as a courtesy. This complimentary assistance is not to be used or relied upon by anyone as a substitute for professional engineering design and documentation required by building code, contract, or applicable law. By accepting these comments you agree they do not constitute any representations, endorsements of, or an assumption by Johns Manville of any liability for either the adequacy of design of this building or any other material not supplied by Johns Manville.

**Note:** For the most current information on general guidelines, please refer to the System Considerations tab under Commercial Roofing Products on the JM Roofing Web site. For specifications, flashing details and general installation information please refer to the Application Tools tab.

Refer to the Safe Use Instructions and product label prior to using this product.

## Mechanically Attached JM TPO - 12" O.C. (Using Perimeter Sheets)

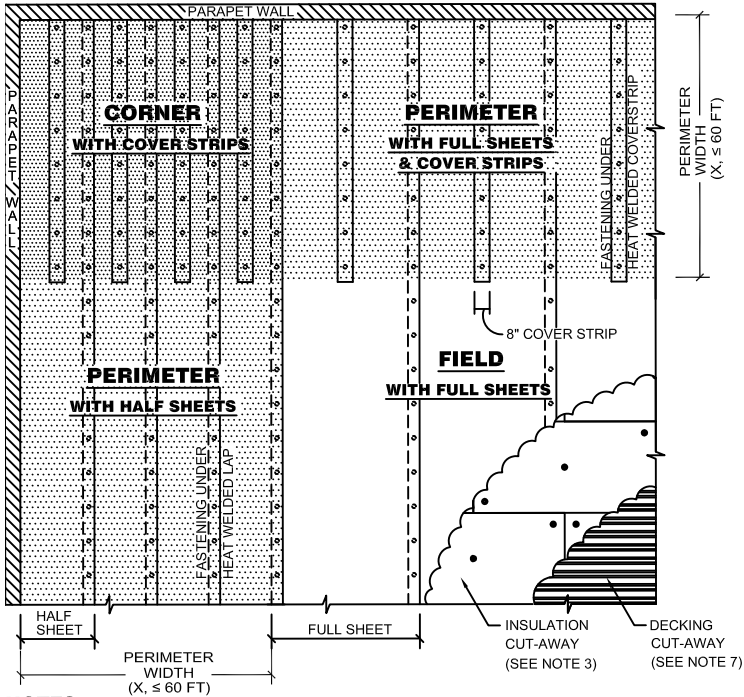

### NOTES

1. CALCULATE UPLIFT DESIGN PRESSURES IN ACCORDANCE WITH ASCE-7.
2. FASTENING DIAGRAM IS BASED ON FM GLOBAL DATA SHEET 1-29.
3. INSTALL INSULATION WITH LONG JOINTS IN A CONTINUOUS STRAIGHT LINE WITH END JOINTS STAGGERED.
4. ROOFS UNDER 60 FT, THE PERIMETER (X) IS THE SMALLER DIMENSION OF:  
10% OF THE SHORTEST SIDE (PLAN VIEW)  
40% OF THE ROOF HEIGHT.
5. ROOFS OVER 60 FT, THE PERIMETER (X) IS:  
10% OF THE SHORTEST SIDE (PLAN VIEW), ONLY.
6. THE CORNERS MAY BE TREATED AS PERIMETERS IF THE PARAPET IS GREATER THAN OR EQUAL TO 3 FT ACCORDING TO ASCE-7.
7. MEMBRANE SIDE LAPS MUST RUN PERPENDICULAR TO THE DECK.
8. FOR CUSTOMERS OUTSIDE OF THE U.S., METRIC FASTENING DIAGRAMS ARE AVAILABLE.

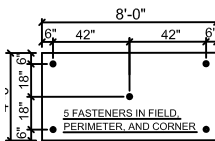

**INSULATION FASTENING**

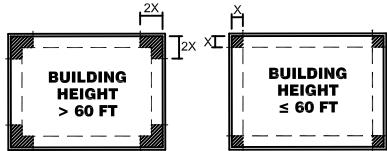
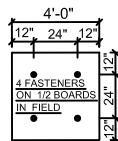

(SEE NOTES 5 & 6)

**CORNER DEFINITION**

Johns Manville is a manufacturer of commercial roofing products and offers this general conceptual information to you as a courtesy. This complimentary assistance is not to be used or relied upon by anyone as a substitute for professional engineering design and documentation required by building code, contract, or applicable law. By accepting these comments you agree they do not constitute any representations, endorsements of, or an assumption by Johns Manville of any liability for either the adequacy of design of this building or any other material not supplied by Johns Manville.

**Note:** For the most current information on general guidelines, please refer to the System Considerations tab under Commercial Roofing Products on the JM Roofing Web site. For specifications, flashing details and general installation information please refer to the Application Tools tab.

Refer to the Safe Use Instructions and product label prior to using this product.

## Mechanically Attached JM TPO - 12" O.C. (Using Cover Strips)

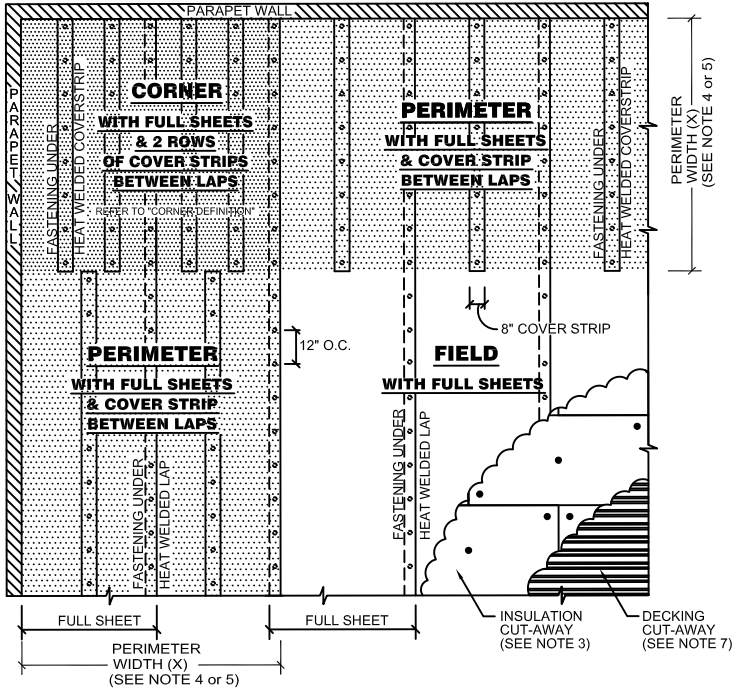

### NOTES

1. CALCULATE UPLIFT DESIGN PRESSURES IN ACCORDANCE WITH ASCE-7.
2. FASTENING DIAGRAM IS BASED ON FM GLOBAL DATA SHEET 1-29.
3. INSTALL INSULATION WITH LONG JOINTS IN A CONTINUOUS STRAIGHT LINE WITH END JOINTS STAGGERED.
4. ROOF HEIGHT  $\leq 60$  FT , THE PERIMETER (X) IS THE SMALLER DIMENSION OF:  
10% OF THE SHORTEST SIDE (PLAN VIEW)  
OR  
40% OF THE ROOF HEIGHT,  
BUT  
NOT LESS THAN 4% OF THE SHORTEST SIDE (PLAN VIEW) OR 3 FEET.
5. ROOF HEIGHT  $> 60$  FT , THE PERIMETER (X) IS:  
10% OF THE SHORTEST SIDE (PLAN VIEW) BUT NOT LESS THAN 3 FEET.
6. THE CORNERS MAY BE TREATED AS PERIMETERS IF THE PARAPET IS GREATER THAN OR EQUAL TO 3 FT ON ALL SIDES ACCORDING TO ASCE-7.
7. MEMBRANE SIDE LAPS MUST RUN PERPENDICULAR TO METAL DECK FLUTES.

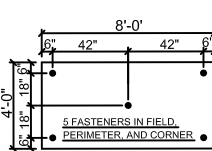

**INSULATION FASTENING**

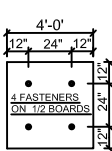

**CORNER DEFINITION**

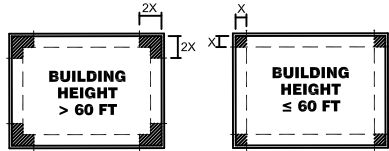

(SEE NOTES 4, 5 & 6)

Johns Manville is a manufacturer of commercial roofing products and offers this general conceptual information to you as a courtesy. This complimentary assistance is not to be used or relied upon by anyone as a substitute for professional engineering design and documentation required by building code, contract, or applicable law. By accepting these comments you agree they do not constitute any representations, endorsements of, or an assumption by Johns Manville of any liability for either the adequacy of design of this building or any other material not supplied by Johns Manville.

**Note:** For the most current information on general guidelines, please refer to the System Considerations tab under Commercial Roofing Products on the JM Roofing Web site. For specifications, flashing details and general installation information please refer to the Application Tools tab.

Refer to the Safe Use Instructions and product label prior to using this product.

## Mechanically Fastened JM TPO - 12" O.C. (Using 10" RPS)

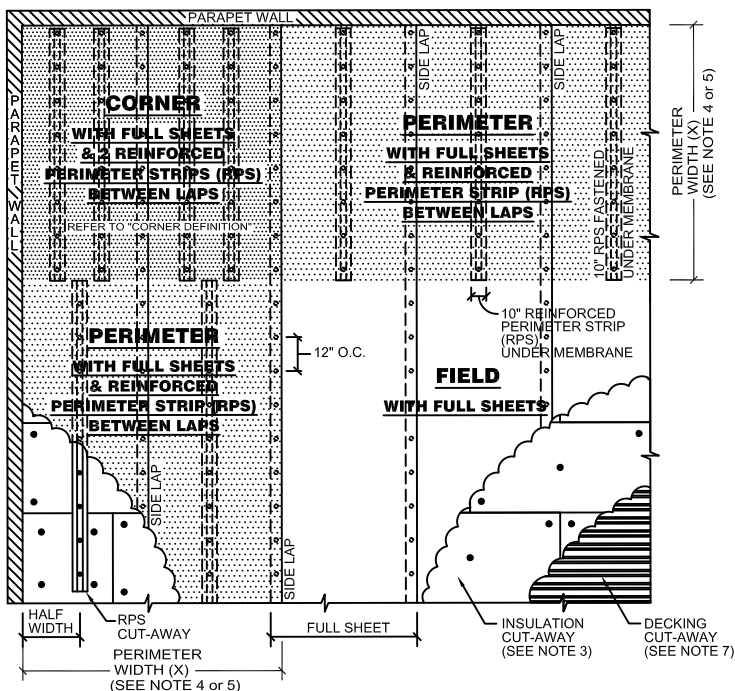

### NOTES

1. CALCULATE UPLIFT DESIGN PRESSURES IN ACCORDANCE WITH ASCE-7.
2. FASTENING DIAGRAM IS BASED ON FM GLOBAL DATA SHEET 1-29.
3. INSTALL INSULATION WITH LONG JOINTS IN A CONTINUOUS STRAIGHT LINE WITH END JOINTS STAGGERED.
4. ROOF HEIGHT  $\leq 60$  FT , THE PERIMETER (X) IS THE SMALLER DIMENSION OF:  
 10% OF THE SHORTEST SIDE (PLAN VIEW) (PLAN VIEW) OR 3 FEET.  
 OR  
 40% OF THE ROOF HEIGHT,  
 BUT  
 NOT LESS THAN 4% OF THE SHORTEST SIDE
5. ROOF HEIGHT  $> 60$  FT , THE PERIMETER (X) IS:  
 10% OF THE SHORTEST SIDE (PLAN VIEW) BUT NOT LESS THAN 3 FEET.
6. THE CORNERS MAY BE TREATED AS PERIMETERS IF THE PARAPET IS GREATER THAN OR EQUAL TO 3 FT ON ALL SIDES ACCORDING TO ASCE-7.
7. MEMBRANE SIDE LAPS MUST RUN PERPENDICULAR TO METAL DECK FLUTES.

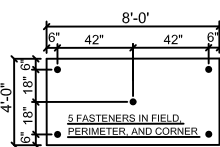

**INSULATION FASTENING**

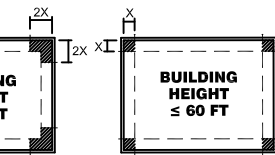
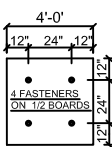

(SEE NOTES 4,5 & 6)

**CORNER DEFINITION**

Johns Manville is a manufacturer of commercial roofing products and offers this general conceptual information to you as a courtesy. This complimentary assistance is not to be used or relied upon by anyone as a substitute for professional engineering design and documentation required by building code, contract, or applicable law. By accepting these comments you agree they do not constitute any representations, endorsements of, or an assumption by Johns Manville of any liability for either the adequacy of design of this building or any other material not supplied by Johns Manville.

**Note:** For the most current information on general guidelines, please refer to the System Considerations tab under Commercial Roofing Products on the JM Roofing Web site. For specifications, flashing details and general installation information please refer to the Application Tools tab.

Refer to the Safe Use Instructions and product label prior to using this product.

## Mechanically Attached JM TPO - 18" O.C. (Using Perimeter Sheets - 5' max in field)

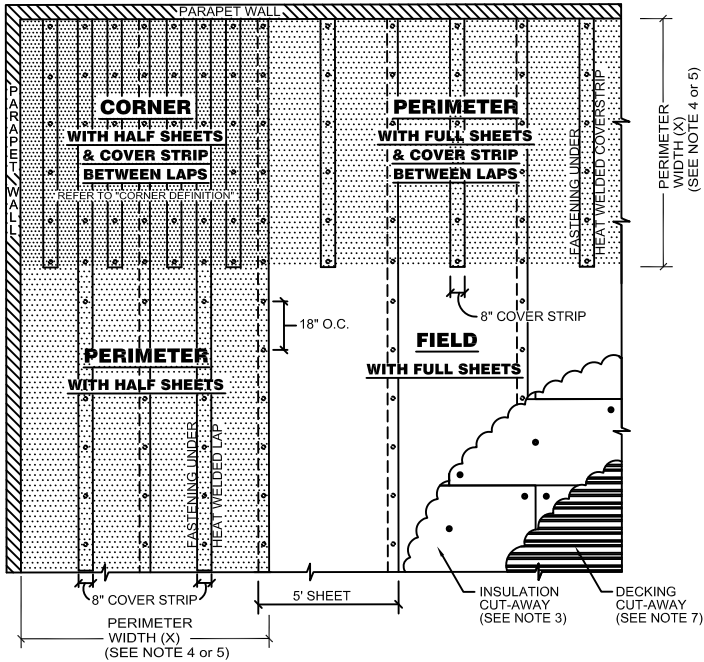

### NOTES

- CALCULATE UPLIFT DESIGN PRESSURES IN ACCORDANCE WITH ASCE-7.
- FASTENING DIAGRAM IS BASED ON FM GLOBAL DATA SHEET 1-29.
- INSTALL INSULATION WITH LONG JOINTS IN A CONTINUOUS STRAIGHT LINE WITH END JOINTS STAGGERED.
- ROOF HEIGHT  $\leq 60$  FT , THE PERIMETER (X) IS THE SMALLER DIMENSION OF:
  - 10% OF THE SHORTEST SIDE (PLAN VIEW)
  - OR
  - 40% OF THE ROOF HEIGHT,
  - BUT
  - NOT LESS THAN 4% OF THE SHORTEST SIDE (PLAN VIEW) OR 3 FEET.
- ROOF HEIGHT  $> 60$  FT , THE PERIMETER (X) IS:
  - 10% OF THE SHORTEST SIDE (PLAN VIEW) BUT NOT LESS THAN 3 FEET.
- THE CORNERS MAY BE TREATED AS PERIMETERS IF THE PARAPET IS GREATER THAN OR EQUAL TO 3 FT ON ALL SIDES ACCORDING TO ASCE-7.
- MEMBRANE SIDE LAPS MUST RUN PERPENDICULAR TO METAL DECK FLUTES.

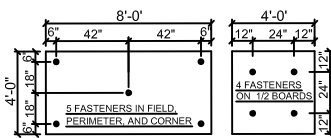

**INSULATION FASTENING**

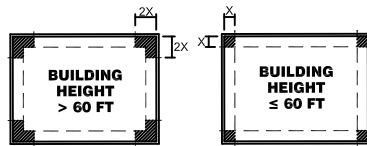

(SEE NOTES 4, 5 & 6)

**CORNER DEFINITION**

Johns Manville is a manufacturer of commercial roofing products and offers this general conceptual information to you as a courtesy. This complimentary assistance is not to be used or relied upon by anyone as a substitute for professional engineering design and documentation required by building code, contract, or applicable law. By accepting these comments you agree they do not constitute any representations, endorsements of, or an assumption by Johns Manville of any liability for either the adequacy of design of this building or any other material not supplied by Johns Manville.

**Note:** For the most current information on general guidelines, please refer to the System Considerations tab under Commercial Roofing Products on the JM Roofing Web site. For specifications, flashing details and general installation information please refer to the Application Tools tab.

Refer to the Safe Use Instructions and product label prior to using this product.

## JM TPO RhinoPlate Fastening System - In Seam 6" O.C.

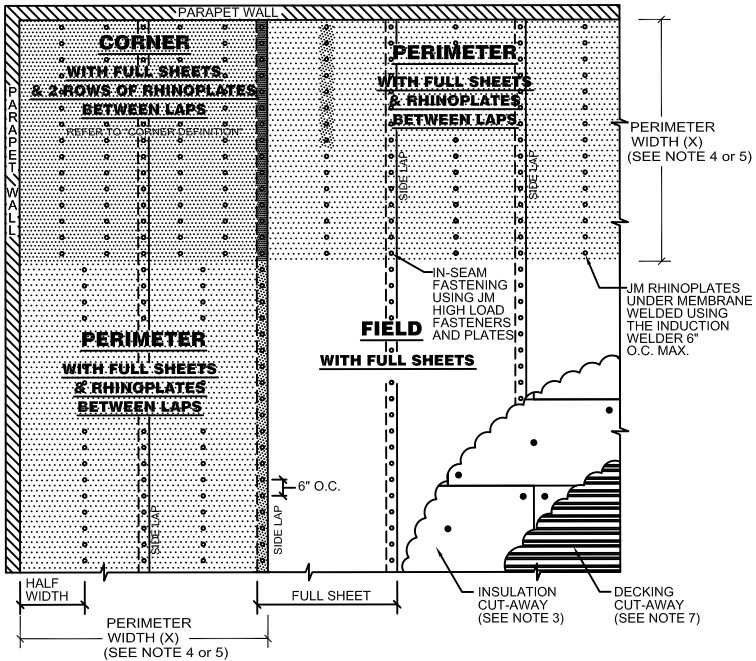

### NOTES

1. CALCULATE UPLIFT DESIGN PRESSURES IN ACCORDANCE WITH ASCE-7.
2. INSTALL INSULATION WITH LONG JOINTS IN A CONTINUOUS STRAIGHT LINE WITH END JOINTS STAGGERED.
3. ROOF HEIGHT  $\leq 60$  FT. THE PERIMETER (X) IS THE SMALLER DIMENSION OF:
  - 10% OF THE SHORTEST SIDE (PLAN VIEW)
  - OR
  - 40% OF THE ROOF HEIGHT,
  - BUT
  - NOT LESS THAN 4% OF THE SHORTEST SIDE (PLAN VIEW) OR 3 FEET.
4. ROOF HEIGHT  $> 60$  FT. THE PERIMETER (X) IS:
  - 10% OF THE SHORTEST SIDE (PLAN VIEW) BUT NOT LESS THAN 3 FEET.
5. THE CORNERS MAY BE TREATED AS PERIMETERS IF THE PARAPET IS GREATER THAN OR EQUAL TO 3 FT ON ALL SIDES ACCORDING TO ASCE-7.
6. MEMBRANE SIDE LAPS MUST RUN PERPENDICULAR TO METAL DECK FLUTES.

### INSULATION FASTENING

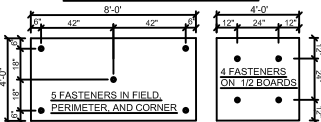

### CORNER DEFINITION

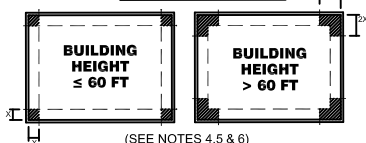

(SEE NOTES 4,5 & 6)

Johns Manville is a manufacturer of commercial roofing products and offers this general conceptual information to you as a courtesy. This complimentary assistance is not to be used or relied upon by anyone as a substitute for professional engineering design and documentation required by building code, contract, or applicable law. By accepting these comments you agree they do not constitute any representations, endorsements of, or an assumption by Johns Manville of any liability for either the adequacy of design of this building or any other material not supplied by Johns Manville.

**Note:** For the most current information on general guidelines, please refer to the System Considerations tab under Commercial Roofing Products on the JM Roofing Web site. For specifications, flashing details and general installation information please refer to the Application Tools tab.

Refer to the Safe Use Instructions and product label prior to using this product.



## JM TPO RhinoPlate Fastening System - In Seam 12" O.C.

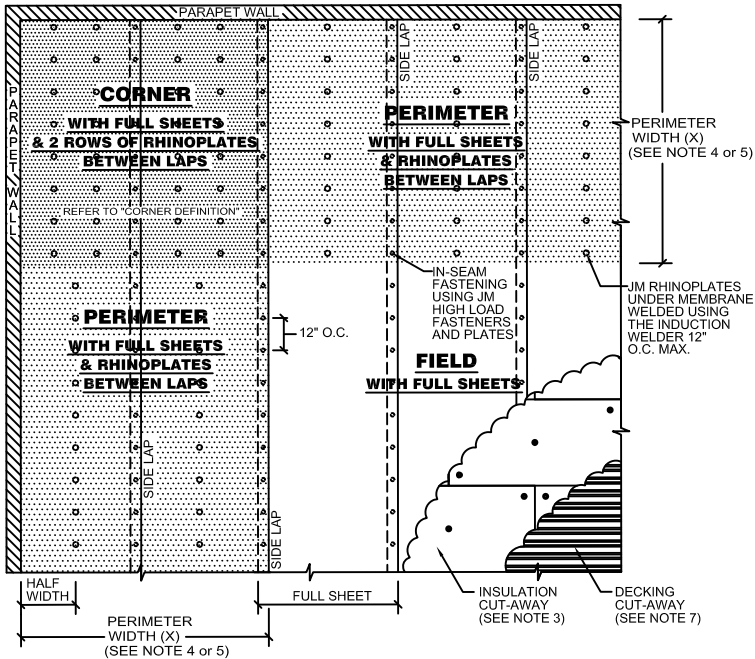

### NOTES

- CALCULATE UPLIFT DESIGN PRESSURES IN ACCORDANCE WITH ASCE-7.
- INSTALL INSULATION WITH LONG JOINTS IN A CONTINUOUS STRAIGHT LINE WITH END JOINTS STAGGERED.
- ROOF HEIGHT  $\leq 60$  FT. THE PERIMETER (X) IS THE SMALLER DIMENSION OF:
  - 10% OF THE SHORTEST SIDE (PLAN VIEW)
  - OR
  - 40% OF THE ROOF HEIGHT, BUT
  - NOT LESS THAN 4% OF THE SHORTEST SIDE (PLAN VIEW) OR 3 FEET.
- ROOF HEIGHT  $> 60$  FT. THE PERIMETER (X) IS:
  - 10% OF THE SHORTEST SIDE (PLAN VIEW) BUT NOT LESS THAN 3 FEET.
- THE CORNERS MAY BE TREATED AS PERIMETERS IF THE PARAPET IS GREATER THAN OR EQUAL TO 3 FT ON ALL SIDES ACCORDING TO ASCE-7.
- MEMBRANE SIDE LAPS MUST RUN PERPENDICULAR TO METAL DECK FLUTES.

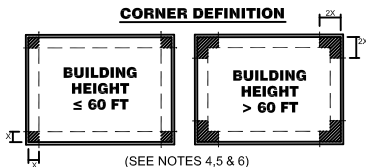
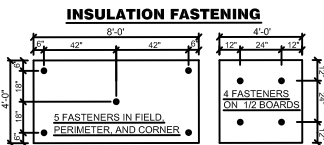

Johns Manville is a manufacturer of commercial roofing products and offers this general conceptual information to you as a courtesy. This complimentary assistance is not to be used or relied upon by anyone as a substitute for professional engineering design and documentation required by building code, contract, or applicable law. By accepting these comments you agree they do not constitute any representations, endorsements of, or an assumption by Johns Manville of any liability for either the adequacy of design of this building or any other material not supplied by Johns Manville.

**Note:** For the most current information on general guidelines, please refer to the System Considerations tab under Commercial Roofing Products on the JM Roofing Web site. For specifications, flashing details and general installation information please refer to the Application Tools tab.

Refer to the Safe Use Instructions and product label prior to using this product.

## JM TPO RhinoPlate Fastening System - 6, 8, 8 Pattern

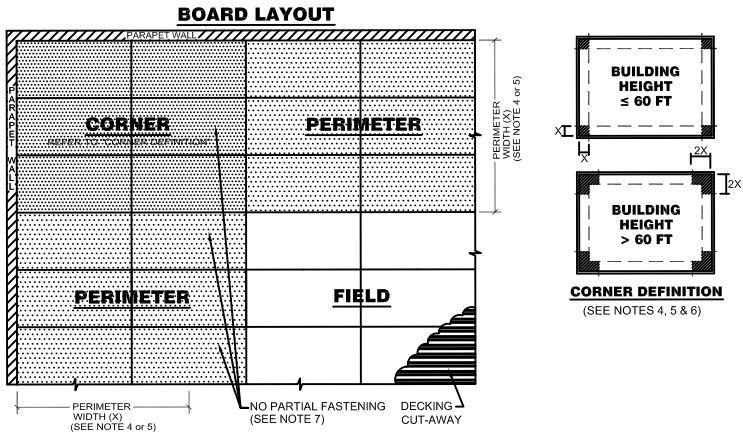

**FASTENING PATTERNS for 4' x 8' INSULATION BOARDS**

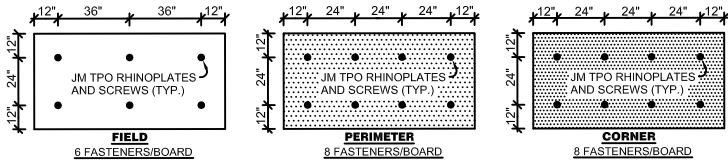

**GENERAL NOTES**

JM TPO MEMBRANE IS HEAT WELDED TO JM TPO RHINOPLATES USING THE RHINO-BOND TOOL.

ALL FASTENERS MUST PENETRATE HIGH RIB OF DECK.

**UPLIFT NOTES**

- CALCULATE UPLIFT DESIGN PRESSURES IN ACCORDANCE WITH ASCE-7.
- INSTALL INSULATION WITH LONG JOINTS AND END JOINTS IN A CONTINUOUS STRAIGHT LINE IN ORDER TO CREATE A LINEAR FASTENING PATTERN. MULTIPLE LAYERS OF INSULATION ARE TO BE STAGGERED.
- ROOF HEIGHT  $\leq$  60 FT., THE PERIMETER (X) IS THE SMALLER DIMENSION OF: 10% OF THE SHORTEST SIDE (PLAN VIEW) OR 40% OF THE ROOF HEIGHT, BUT NOT LESS THAN 4% OF THE SHORTEST SIDE (PLAN VIEW) OR 4 FEET.
- ROOF HEIGHT  $>$  60 FT., THE PERIMETER (X) IS: 10% OF THE SHORTEST SIDE (PLAN VIEW) BUT NOT LESS THAN 4 FEET.
- THE CORNERS MAY BE TREATED AS PERIMETERS IF THE PARAPET IS GREATER THAN OR EQUAL TO 3 FT ON ALL SIDES ACCORDING TO ASCE-7.
- IF ANY PORTION OF THE BOARD LIES IN A PERIMETER OR CORNER ZONE, ENHANCE THE FASTENING OF ENTIRE BOARD.

Johns Manville is a manufacturer of commercial roofing products and offers this general conceptual information to you as a courtesy. This complimentary assistance is not to be used or relied upon by anyone as a substitute for professional engineering design and documentation required by building code, contract, or applicable law. By accepting these comments you agree they do not constitute any representations, endorsements of, or an assumption by Johns Manville of any liability for either the adequacy of design of this building or any other material not supplied by Johns Manville.

**Note:** For the most current information on general guidelines, please refer to the System Considerations tab under Commercial Roofing Products on the JM Roofing Web site. For specifications, flashing details and general installation information please refer to the Application Tools tab.

Refer to the Safe Use Instructions and product label prior to using this product.



## JM TPO RhinoPlate Fastening System - 6, 8, Pattern

### BOARD LAYOUT

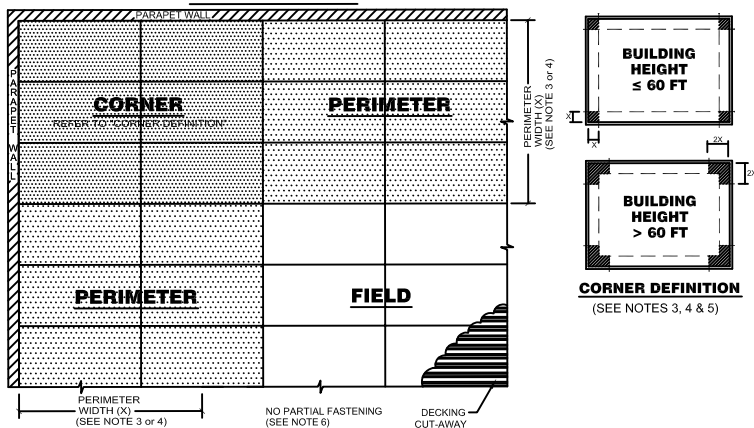

### FASTENING PATTERNS for 4' x 8' INSULATION BOARDS

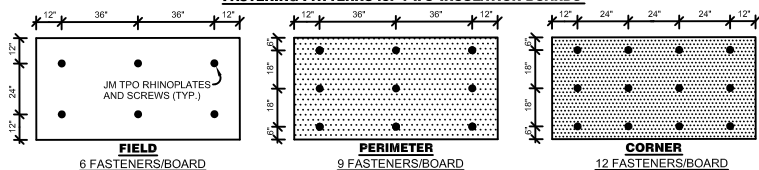

#### GENERAL NOTES

JM TPO MEMBRANE IS HEAT WELDED TO JM TPO RHINOPLATES USING THE RHINO BOND TOOL.

ALL FASTENERS MUST PENETRATE HIGH RIB OF DECK.

THE ABOVE FASTENING PATTERN ASSUMES THE PULLOUT TESTS ON FASTENERS ACHIEVE A 480 POUND PULLOUT VALUE.

#### UPLIFT NOTES

- CALCULATE UPLIFT DESIGN PRESSURES IN ACCORDANCE WITH ASCE-7.
- INSTALL INSULATION WITH LONG JOINTS AND END JOINTS IN A CONTINUOUS STRAIGHT LINE IN ORDER TO CREATE A LINEAR FASTENING PATTERN. MULTIPLE LAYERS OF INSULATION ARE TO BE STAGGERED.
- ROOF HEIGHT  $\leq 60$  FT, THE PERIMETER (X) IS THE SMALLER DIMENSION OF:
  - 10% OF THE SHORTEST SIDE (PLAN VIEW)
  - OR
  - 40% OF THE ROOF HEIGHT,
  - BUT
  - NOT LESS THAN 4% OF THE SHORTEST SIDE (ELEVATION VIEW) OR 4 FEET.
- ROOF HEIGHT  $> 60$  FT THE PERIMETER (X) IS:
  - 10% OF THE SHORTEST SIDE (PLAN VIEW) BUT NOT LESS THAN 4 FEET.
- THE CORNERS MAY BE TREATED AS PERIMETERS IF THE PARAPET IS GREATER THAN OR EQUAL TO 3 FT ON ALL SIDES ACCORDING TO ASCE-7.
- IF ANY PORTION OF THE BOARD LIES IN A PERIMETER OR CORNER ZONE, ENHANCE THE FASTENING OF ENTIRE BOARD.

Johns Manville is a manufacturer of commercial roofing products and offers this general conceptual information to you as a courtesy. This complimentary assistance is not to be used or relied upon by anyone as a substitute for professional engineering design and documentation required by building code, contract, or applicable law. By accepting these comments you agree they do not constitute any representations, endorsements of, or an assumption by Johns Manville of any liability for either the adequacy of design of this building or any other material not supplied by Johns Manville.

**Note:** For the most current information on general guidelines, please refer to the System Considerations tab under Commercial Roofing Products on the JM Roofing Web site. For specifications, flashing details and general installation information please refer to the Application Tools tab.

Refer to the Safe Use Instructions and product label prior to using this product.

## JM TPO RhinoPlate Fastening System - 6, 10, 15 Pattern

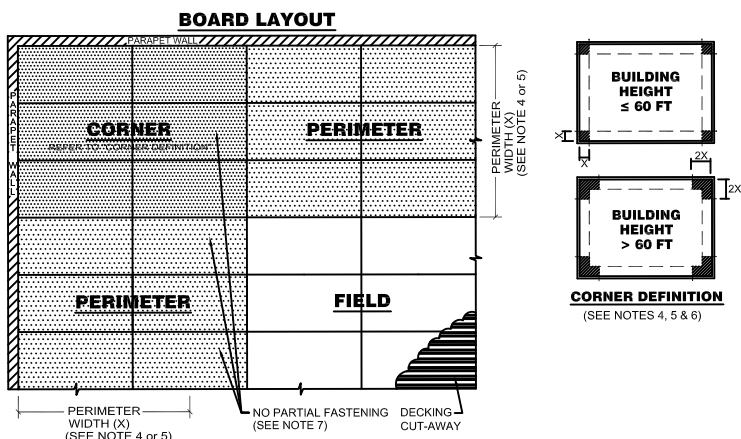

### GENERAL NOTES

JM PVC MEMBRANE IS HEAT WELDED TO JM PVC RHINOPLATES USING THE RHINOBOND TOOL.

ALL FASTENERS MUST PENETRATE HIGH RIB OF DECK.

### UPLIFT NOTES

- CALCULATE UPLIFT DESIGN PRESSURES IN ACCORDANCE WITH ASCE-7.
- FASTENING DIAGRAM IS BASED ON FM GLOBAL DATA SHEET 1-29.
- THIS MEMBRANE FASTENING PATTERN ACHIEVES AN FM 1-90 UPLIFT RATING OVER AN FM APPROVED DECK.
- INSTALL INSULATION WITH LONG JOINTS AND END JOINTS IN A CONTINUOUS STRAIGHT LINE IN ORDER TO CREATE A LINEAR FASTENING PATTERN. MULTIPLE LAYERS OF INSULATION ARE TO BE STAGGERED.
- ROOF HEIGHT  $\leq$  60 FT., THE PERIMETER (X) IS THE SMALLER DIMENSION OF:
  - 10% OF THE SHORTEST SIDE (PLAN VIEW)
  - OR
  - 40% OF THE ROOF HEIGHT.
  - BUT
  - NOT LESS THAN 4% OF THE SHORTEST SIDE (PLAN VIEW) OR 4 FEET.
- ROOF HEIGHT > 60 FT., THE PERIMETER (X) IS:
  - 10% OF THE SHORTEST SIDE (PLAN VIEW) BUT NOT LESS THAN 4 FEET.
- THE CORNERS MAY BE TREATED AS PERIMETERS IF THE PARAPET IS GREATER THAN OR EQUAL TO 3 FT ON ALL SIDES ACCORDING TO ASCE-7.
- IF ANY PORTION OF THE BOARD LIES IN A PERIMETER OR CORNER ZONE. ENHANCE THE FASTENING OF ENTIRE BOARD.

Johns Manville is a manufacturer of commercial roofing products and offers this general conceptual information to you as a courtesy. This complimentary assistance is not to be used or relied upon by anyone as a substitute for professional engineering design and documentation required by building code, contract, or applicable law. By accepting these comments you agree they do not constitute any representations, endorsements of, or an assumption by Johns Manville of any liability for either the adequacy of design of this building or any other material not supplied by Johns Manville.

**Note:** For the most current information on general guidelines, please refer to the System Considerations tab under Commercial Roofing Products on the JM Roofing Web site. For specifications, flashing details and general installation information please refer to the Application Tools tab.

Refer to the Safe Use Instructions and product label prior to using this product.

## JM TPO RhinoPlate Fastening System - 8, 12, 16 Pattern

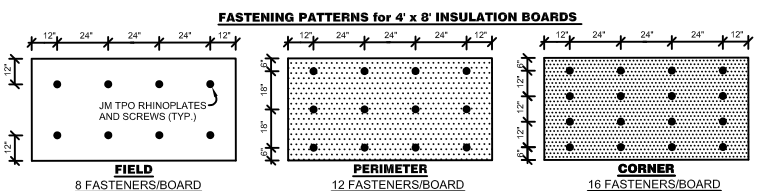
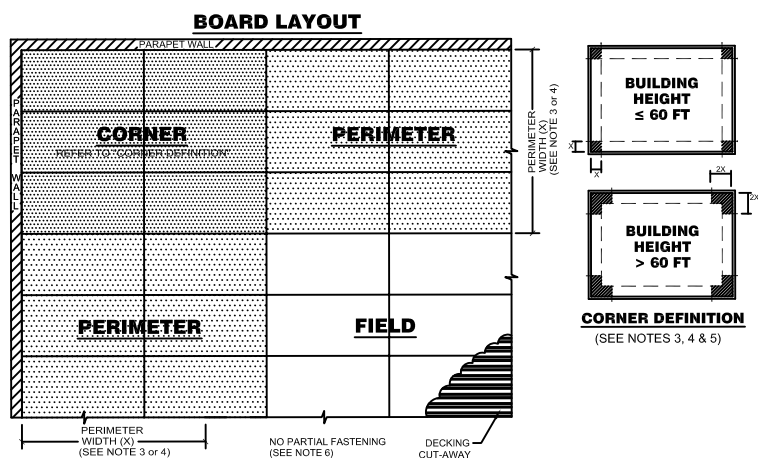

### GENERAL NOTES

JM PVC MEMBRANE IS HEAT WELDED TO JM PVC RHINOPLATES USING THE RHINOBOND TOOL.

ALL FASTENERS MUST PENETRATE HIGH RIB OF DECK.

### UPLIFT NOTES

- CALCULATE UPLIFT DESIGN PRESSURES IN ACCORDANCE WITH ASCE-7.
- FASTENING DIAGRAM IS BASED ON FM GLOBAL DATA SHEET 1-29.
- INSTALL INSULATION WITH LONG JOINTS AND END JOINTS IN A CONTINUOUS STRAIGHT LINE IN ORDER TO CREATE A LINEAR FASTENING PATTERN. MULTIPLE LAYERS OF INSULATION ARE TO BE STAGGERED.
- ROOF HEIGHT ≤ 60 FT., THE PERIMETER (X) IS THE SMALLER DIMENSION OF:
  - 10% OF THE SHORTEST SIDE (PLAN VIEW)
  - OR
  - 40% OF THE ROOF HEIGHT,
  - BUT
  - NOT LESS THAN 4% OF THE SHORTEST SIDE.** (PLAN VIEW) OR 4 FEET.
- ROOF HEIGHT > 60 FT., THE PERIMETER (X) IS:
  - 10% OF THE SHORTEST SIDE (PLAN VIEW) BUT NOT LESS THAN 4 FEET.
- THE CORNERS MAY BE TREATED AS PERIMETERS IF THE PARAPET IS GREATER THAN OR EQUAL TO 3 FT ON ALL SIDES ACCORDING TO ASCE-7.
- IF ANY PORTION OF THE BOARD LIES IN A PERIMETER OR CORNER ZONE, ENHANCE THE FASTENING OF ENTIRE BOARD.

Johns Manville is a manufacturer of commercial roofing products and offers this general conceptual information to you as a courtesy. This complimentary assistance is not to be used or relied upon by anyone as a substitute for professional engineering design and documentation required by building code, contract, or applicable law. By accepting these comments you agree they do not constitute any representations, endorsements of, or an assumption by Johns Manville of any liability for either the adequacy of design of this building or any other material not supplied by Johns Manville.

**Note:** For the most current information on general guidelines, please refer to the System Considerations tab under Commercial Roofing Products on the JM Roofing Web site. For specifications, flashing details and general installation information please refer to the Application Tools tab.

Refer to the Safe Use Instructions and product label prior to using this product.

## JM TPO RhinoPlate Fastening System - 8, 15, 20 Pattern

### BOARD LAYOUT

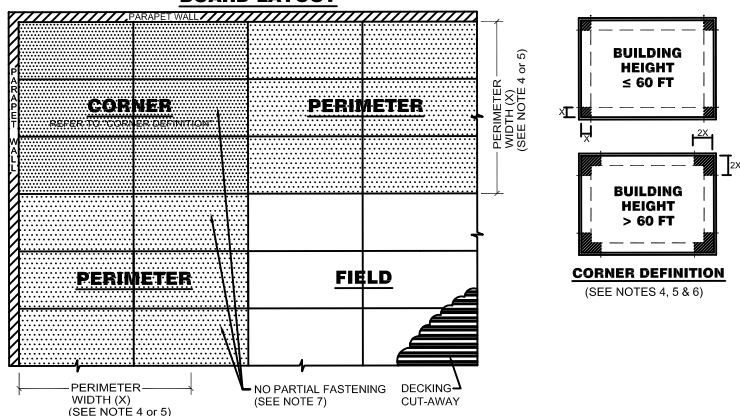

### FASTENING PATTERNS for 4' x 8' INSULATION BOARDS

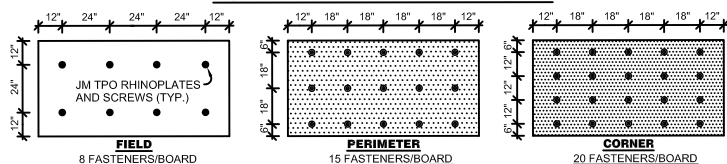

### GENERAL NOTES

JM PVC MEMBRANE IS HEAT WELDED TO JM PVC RHINOPLATES USING THE RHINOBOND TOOL.

ALL FASTENERS MUST PENETRATE HIGH RIB OF DECK.

### UPLIFT NOTES

- CALCULATE UPLIFT DESIGN PRESSURES IN ACCORDANCE WITH ASCE-7.
- FASTENING DIAGRAM IS BASED ON FM GLOBAL DATA SHEET 1-29.
- THIS MEMBRANE FASTENING PATTERN ACHIEVES AN FM 1-135 UPLIFT RATING OVER AN FM APPROVED DECK.
- INSTALL INSULATION WITH LONG JOINTS AND END JOINTS IN A CONTINUOUS STRAIGHT LINE IN ORDER TO CREATE A LINEAR FASTENING PATTERN. MULTIPLE LAYERS OF INSULATION ARE TO BE STAGGERED.
- ROOF HEIGHT  $\leq 60$  FT, THE PERIMETER (X) IS THE SMALLER DIMENSION OF:
  - 10% OF THE SHORTEST SIDE (PLAN VIEW)
  - OR
  - 40% OF THE ROOF HEIGHT,
  - BUT
  - NOT LESS THAN 4% OF THE SHORTEST SIDE (PLAN VIEW) OR 4 FEET.
- ROOF HEIGHT  $> 60$  FT, THE PERIMETER (X) IS:
  - 10% OF THE SHORTEST SIDE (PLAN VIEW) BUT NOT LESS THAN 4 FEET.
- THE CORNERS MAY BE TREATED AS PERIMETERS IF THE PARAPET IS GREATER THAN OR EQUAL TO 3 FT ON ALL SIDES ACCORDING TO ASCE-7.
- IF ANY PORTION OF THE BOARD LIES IN A PERIMETER OR CORNER ZONE, ENHANCE THE FASTENING OF ENTIRE BOARD.

Johns Manville is a manufacturer of commercial roofing products and offers this general conceptual information to you as a courtesy. This complimentary assistance is not to be used or relied upon by anyone as a substitute for professional engineering design and documentation required by building code, contract, or applicable law. By accepting these comments you agree they do not constitute any representations, endorsements of, or an assumption by Johns Manville of any liability for either the adequacy of design of this building or any other material not supplied by Johns Manville.

**Note:** For the most current information on general guidelines, please refer to the System Considerations tab under Commercial Roofing Products on the JM Roofing Web site. For specifications, flashing details and general installation information please refer to the Application Tools tab.

Refer to the Safe Use Instructions and product label prior to using this product.

# 4

## **JM TPO Membrane Flashing Details**

# 4

## JM TPO Membrane Flashing Details



Download a free QR Reader app on your smart phone. When you see a QR code, use your phone to scan the code. It will then redirect your phone to a specific video or detail. These codes will allow you to view step by step instructional videos and will allow you to zoom in on details for better readability. If you are viewing this booklet online you can click on these codes to direct you to the online videos and details as well.

### **Disclaimer:**

The TPO Roofing Systems Commercial Roofing Application Guide is intended as a guide only; actual conditions encountered during installation may vary from jobsite to jobsite. By providing this guidance, Johns Manville assumes no responsibility for quality of installation, field workmanship, building code compliance, or job safety. Johns Manville Material Safety Data Sheets (MSDS) are available with specific product safety information. For information on other Johns Manville thermal insulations and systems, call (800) 922-5922 or visit JM.com.

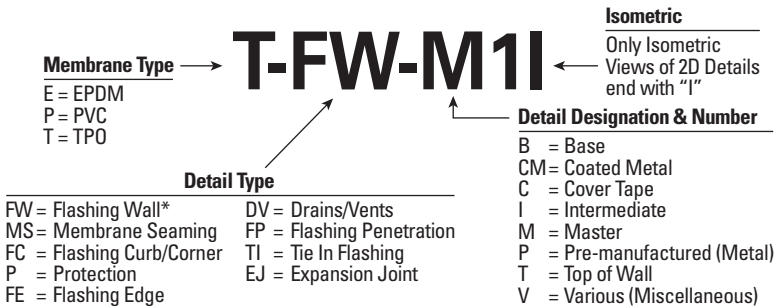

\* Flashing Wall Details (FW) have Master Details (M) in both 2D and isometric that coordinate all the other Flashing Wall Details.

New Detail Number	Old Detail Number	Detail Description	Attachment Method	MF	AD	SA	Page No.
<b>TPO Flashing Wall Details</b>							
<u>Master Details</u>							
T-FW-M1	New	TPO Base & Wall Flashing with Coping Master Detail	X	X			4-5
T-FW-M1I	TW-35	TPO Base & Wall Flashing with Coping Isometric View Master Detail	X	X			4-6
T-FW-M2I	TW-34	Highwall Flashing with Metal Backing Strip Isometric View Master Detail	X	X			4-7
T-FW-M3I	New	Self-Adhered TPO Base & Wall Flashing with Coping Isometric View				X	4-8
T-FW-M5I	New	TPO Membrane Mechanically Fastened with Rhinoplastes Master Detail				X	4-9
T-FW-M6I	New	TPO Rhinoplastes on Vertical Surface Wall Flashing Isometric View				X	4-10
<u>Base Tie-In Details</u>							
T-FW-B1	TB-18	Base Flashing with Horizontal Reinforced Termination Strip - RTS	X	X			4-11
T-FW-B2	TB-19	Base Flashing with Vertical Reinforced Termination Strip - RTS	X	X			4-12
T-FW-B3	TB-26	Base Tie-In - Fastener & Plate	X	X			4-13
T-FW-B4	New	Base Tie-In - Fastener & Plate on Wall	X	X			4-14
T-FW-B5	TB-26A	Membrane Flashing Base Tie-In - High Internal Pressure	X	X			4-15
T-FW-B6	TB-27	Base Tie-In - RhinoPlate System	X				4-16
T-FW-B7	TB-27	Base Tie-In - Knee Wall Brace	X				4-17
T-FW-B8	TB-27	Loose Hung Flashing	X				4-18
T-FW-B9	New	TPO Self-Adhered Base Tie-In Fastener & Plate				X	4-19
T-FW-B10	New	TPO Self-Adhered Base Tie-In Fastener & Plate on Wall				X	4-20
T-FW-B11	New	TPO Self-Adhered Membrane Flashing Base Tie In High Int. Pressure				X	4-21
T-FW-B12	New	TPO Self-Adhered Base Tie-In Fastener & Plate with TPO Cover Strip				X	4-22
<u>Intermediate Termination Details</u>							
T-FW-I1	TW-39-ADH	TPO Intermediate Membrane Attachment with Fastener & Plate	X	X			4-23
T-FW-I2	TW-32C	TPO Cover Strip Wall Flashing Attachment with Fastener & Plate	X	X			4-24
T-FW-I3	New	TPO Intermediate Membrane Attachment with Termination Bar	X	X			4-25
T-FW-I4	New	Termination Bar Flashing Attachment with Welded TPO Cover Strip	X	X			4-26
T-FW-I5	TW-32B	Continuous Flashing Attachment - Termination Bar	X	X			4-27
T-FW-I6	New	Split Flashing Attachment - Termination Bar	X	X			4-28
T-FW-I7	TC-43	TPO Intermediate Termination with Counter-flashing & Cut-In Reglet	X	X			4-29
T-FW-I8	TC-41	TPO Intermediate Termination with Surface Mounted Counter-flashing	X	X			4-30
T-FW-I9	New	TPO Intermediate Termination with Thru Wall Counter Flashing	X	X			4-31
T-FW-I10	TC-44	TPO Intermediate Termination with Termination Bar	X	X			4-32
T-FW-I11	New	TPO Intermediate Termination Below Wall Cladding	X	X			4-33
T-FW-I12	New	TPO Intermediate Membrane Termination with Termination Bar	X	X			4-34
T-FW-I13	New	TPO Intermediate Termination Loose Hung Flashing	X				4-35

New Detail Number	Old Detail Number	Detail Description	Attachment Method	MF	AD	SA	Page No.
<u>Top of Wall Details</u>							
T-FW-T1	New	Fabricated Metal Coping Over Adhered TPO	X	X			4-36
T-FW-T2	New	Presto Lock Coping System Over TPO	X	X			4-37
T-FW-T3	TW-35	Presto-Tite Fascia System on Sloped Parapet	X	X			4-38
T-FW-T4	New	Perma-Tite Continuous Coping System Over TPO	X	X			4-39
<b>TPO Membrane Seaming Details</b>							
T-MS-01	New	Cut Edge Sealant	X	X			4-40
T-MS-02	TA-1	In Lap Fastening Method - Steel Deck	X				4-41
T-MS-03	TA-1A	In Lap Fastening Method - Plywood Deck	X				4-42
T-MS-04	TA-1B	In Lap Fastening Method - Concrete Deck	X				4-43
T-MS-05	TA-1C	In Lap Fastening Method - Wood Plank Deck	X				4-44
T-MS-06	TA-2	Continuous Strip Fastening Method	X				4-45
T-MS-07	TA-5-ADH	Membrane Side Lap	X	X			4-46
T-MS-08	TA-6-ADH	TPO Fleece Backed Adhesive Applied Membrane Butted End Lap	X	X			4-47
T-MS-09	TT-86	Slope Transition - Valley	X	X			4-48
T-MS-10	TT-89	Slope Transition - Ridge	X	X			4-49
T-MS-11	New	TPO Self-Adhered Membrane Butted End Lap				X	4-50
<b>TPO Flashing Curb &amp; Corner Details</b>							
T-FC-01	TF-64ADH	Prefabricated Metal Curb Base Flashing	X	X			4-51
T-FC-02	New	Roof Hatch	X	X			4-52
T-FC-03	TF-62A	TPO Outside Corner	X	X			4-53
T-FC-04	TF-63	TPO Inside Corner	X	X			4-54
T-FC-05	New	TPO Wood Curb Base Flashing	X	X			4-55
<b>TPO Protection Details</b>							
T-PT-01	TM-90	Support-Light	X	X			4-56
T-PT-02	TM-91	Support-Medium	X	X			4-57
T-PT-03	TM-92	Support-Heavy	X	X			4-58
T-PT-04	TM-94	Walkway-Concrete Paver	X	X			4-59
T-PT-05	TM-93A	TPO Walkpads Over Adhered TPO Membrane				X	4-60
T-PT-06	TM-98-ADH	TPO Walkpad Fleece Backed System Adhered				X	4-61
T-PT-07	TM-93M	TPO Walkpad Over Mechanically Fastened TPO Membrane	X				4-62
T-PT-08	New	Lightning Rod-Wall Mount	X	X			4-63
T-PT-09	TM-95&96	Lightning Rod-Roof Mount	X	X			4-64
T-PT-10	TM-97	Grease Trap	X	X			4-65
T-PT-11	New	JM Single Ply Safety Strip Over TPO Membrane	X	X			4-66
T-PT-12	New	JM ENRGY Anchor - TPO	X	X			4-67
<b>TPO Flashing Edge Details</b>							
<u>TPO Cover Tape Details</u>							
T-FE-C1	TE-13B	Metal Drip Edge with TPO Cover Tape	X	X			4-68
T-FE-C2	New	Gravel Stop with TPO Cover Tape	X	X			4-69
T-FE-C3	New	Gutter & Metal Edge with TPO Cover Tape	X	X			4-70
<u>TPO-Coated Metal Details</u>							
T-FE-CM1	TE-13	Drip Edge - TPO-Coated Metal	X	X			4-71
T-FE-CM2	New	Drip Edge - TPO-Coated Metal Adhered Membrane Only				X	4-72
T-FE-CM3	TE-11	Gravel Stop - TPO-Coated Metal	X	X			4-73
T-FE-CM4	TE-11A	Gravel Stop - TPO-Coated Metal Adhered Membrane Only				X	4-74
T-FE-CM5	TE-14	Gutter & TPO-Coated Metal Edge	X	X			4-75
T-FE-CM6	TE-15	Butt Joint at Edge - TPO-Coated Metal	X	X			4-76
<u>Pre-Manufactured (Metal) Details</u>							
T-FE-P1	New	JM Presto-Tite Drip Edge	X	X			4-77
T-FE-P2	TE-12A	JM Presto-Tite Fascia System for Single Ply Systems	X	X			4-78
T-FE-P3	New	JM Presto-Tite Edge One Fascia System	X	X			4-79
T-FE-P4	New	JM Perma-Tite System 200 Fascia	X	X			4-80
T-FE-P5	New	JM Metal Drip Edge with TPO Cover Tape	X	X			4-81
T-FE-P6	New	JM Gravel Stop with TPO Cover Tape	X	X			4-82
T-FE-P7	New	JM TPO Presto Weld Drip Edge	X	X			4-83



New Detail Number	Old Detail Number	Detail Description	Attachment		Page No.
			Method	MF AD	
<b>Various (Miscellaneous) Details</b>					
T-FE-V1	TA-4	Wood Nailer Attachment	X	X	4-84
T-FE-V2	New	Gutter & Termination Bar		X	4-85
T-FE-V3	TB-17	RhinoPlate - Standing Seam Retro-Fit Purlin Attachment	X		4-86
T-FE-V4	TE-18	RhinoPlate - Standing Seam Retro-Fit Gravel Stop	X		4-87
T-FE-V5	TE-19	RhinoPlate - Standing Seam Retro-Fit Gutter	X		4-88
<b>TPO Drains &amp; Vents Details</b>					
T-DV-01	TF-52	Vent Pipe	X	X	4-89
T-DV-02	New	Vent Pipe - Hot	X	X	4-90
T-DV-03	TF-58	Through-Wall Scupper	X	X	4-91
T-DV-03I	New	Through-Wall Scupper	X	X	4-92
T-DV-04	TF-58A	Primary Scupper with Tapered Insulation Sump	X	X	4-93
T-DV-05	TF-58B	Low Wall Primary Scupper Flashing	X	X	4-94
T-DV-06	TF-58C	Overflow Scupper	X	X	4-95
T-DV-07	New	Primary Drain Sump - Low Slope - Less Than 3:12 Slope	X	X	4-96
T-DV-08	New	Primary Drain Sump - Steep Slope - Greater Than 3:12 Slope	X	X	4-97
T-DV-09	New	Primary Drain Sump - Fleece Backed Membrane	X	X	4-98
T-DV-09I	TF-65-ADH	TPO Fleece Backed Adhesive Applied Primary Drain In Sump	X	X	4-99
T-DV-10	New	JM Heavy Duty TPO Retro Drain	X	X	4-100
T-DV-11	New	Primary Drain Sump - Mechanically Fastened Membrane	X		4-101
<b>TPO Flashing Penetration Details</b>					
T-FP-01	TF-50S	TPO Pipe Boot	X	X	4-102
T-FP-02	TF-53	JM TPO 2 Piece Penetration Pocket	X	X	4-103
T-FP-03	TF-54	TPO-Coated Metal Penetration Pocket	X	X	4-104
T-FP-04	New	TPO Split Pipe Boot - Round	X	X	4-105
T-FP-05	New	TPO Split Pipe Boot - Square	X	X	4-106
T-FP-06	New	TPO Split Pipe Boot - Square - Clamped	X	X	4-107
T-FP-07	TF-51	Field Fabricated Pipe Penetration	X	X	4-108
<b>TPO Tie-In Flashing Details</b>					
T-TI-01	TT-80	Transition for Staged Roofing - TPO-Coated Metal	X	X	4-109
T-TI-02	TT-82	Transition to Shingle Roof with TPO-Coated Metal	X	X	4-110
T-TI-03	TT-72	Curb Tie-In to Roof By Others	X	X	4-111
<b>TPO Expansion Joint Details</b>					
T-EJ-01	TT-70	Expansion Joint-Roof to Wall	X	X	4-112
T-EJ-02	TT-71	Expansion Joint-Roof to Roof	X	X	4-113
T-EJ-03	New	Expand-0-Flash Roof to Roof Expansion Joint Cover - Style TPO EJ	X	X	4-114
T-EJ-04	New	Expand-0-Flash Roof to Wall - Style EJ	X	X	4-115
T-EJ-05	New	Expand-0-Flash Curb to Curb Expansion Joint Cover - Style CF	X	X	4-116
T-EJ-06	New	Expand-0-Flash Curb to Wall Expansion Joint Cover - Style CF/EJ	X	X	4-117
<b>Vapor Barrier Flashing Details</b>					
VB-1		JM Vapor Barrier SA - Wall Base Detail	X	X	4-118
VB-1(ALT)		JM Vapor Barrier SA - Wall Base Detail (ALT)	X	X	4-119
VB-2		JM Vapor Barrier SA - Pipe Penetration Detail	X	X	4-120
VB-3		JM Vapor Barrier SA - Drain Detail	X	X	4-121
VB-4		JM Vapor Barrier SA - Detail at Field Laps	X	X	4-122
VB-5		JM Vapor Barrier SA - Outside Curb Detail	X	X	4-123
VB-6		JM Vapor Barrier SA - Inside Curb Detail	X	X	4-124

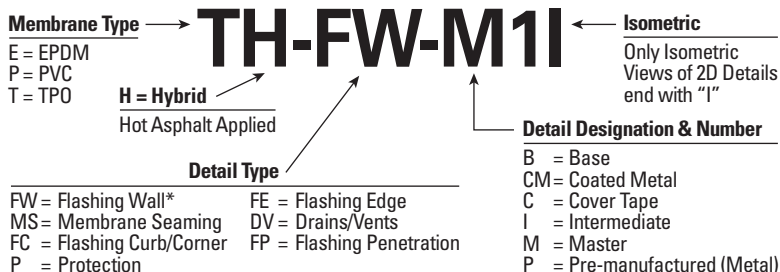

\* Flashing Wall Details (FW) have Master Details (M) in both 2D and isometric that coordinate all the other Flashing Wall Details.

## TPO Hybrid

New Detail Number	Old Detail Number	Detail Description	Attachment Method FA	Page No.
<b>Flashing Wall Details</b>				
<u>Master Details</u>				
TH-FW-M1	New	TPO Hybrid Base & Wall Flashing with Coping Master Detail	X	4-126
TH-FW-M1I	New	TPO Hybrid Base & Wall Flashing with Coping Isometric View Master Detail	X	4-127
TH-FW-M2I	New	Highwall Flashing with Metal Backing Strip Isometric View Master Detail	X	4-128
<u>Base Tie-In Details</u>				
T-FW-B1	New	Base Tie-In with Termination Bar	X	4-129
T-FW-B2	New	Base Tie-In Fastener & Plate with Cant	X	4-130
T-FW-B3	New	Base Tie-In Fastener & Plate on Wall	X	4-131
T-FW-B4	New	Base Tie-In with Termination Bar	X	4-132
<b>Membrane Seaming Details</b>				
TH-MS-01	New	TPO Fleece Backed Membrane Butted End Lap	X	4-133
<b>Flashing Curb &amp; Corner Details</b>				
TH-FC-01	New	Prefabricated Metal Curb Base Flashing with Cant	X	4-134
TH-FC-02	New	Prefabricated Metal Base Flashing	X	4-135
<b>Flashing Edge Details</b>				
<u>TPO-Coated Metal Details</u>				
TH-FE-CM1	New	Drip Edge - TPO-Coated Metal	X	4-136
TH-FE-CM2	New	Gravel Stop - TPO-Coated Metal	X	4-137
TH-FE-CM3	New	Gutter & TPO-Coated Metal Edge	X	4-138
<u>Pre-Manufactured (Metal) Details</u>				
TH-FE-P1	New	JM Presto-Tite Edge One Fascia System	X	4-139
TH-FE-P2	New	JM Presto-Tite Fascia System	X	4-140
<b>Drain &amp; Vents Details</b>				
TH-DV-01	New	Field Fabricated Vent Pipe	X	4-141
TH-DV-02	New	Drain Detail	X	4-142
TH-DV-03	New	Vent Pipe	X	4-143
<b>Flashing Penetration Details</b>				
TH-FP-01	New	Pipe Boot	X	4-144



## TPO Base & Wall Flashing with Coping Master Detail

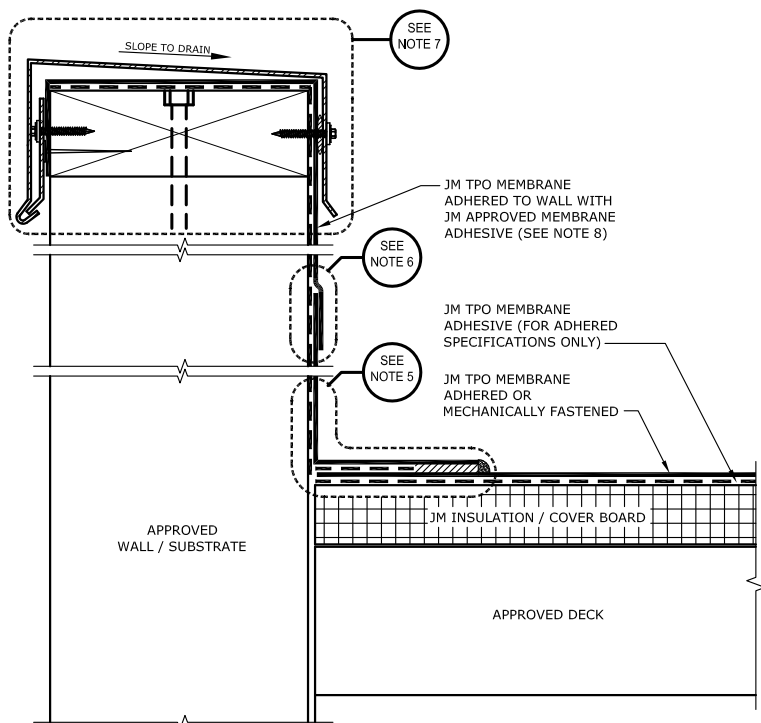

### NOTES:

1. REFER TO JOHNS MANVILLE WEBSITE ([www.jm.com](http://www.jm.com)) FOR MOST UP-TO-DATE INFORMATION.
2. PLEASE SEE SINGLE PLY FLASHING SPECIFICATIONS FOR A FULL DESCRIPTION OF INSTALLATION INSTRUCTIONS AND REQUIREMENTS WHICH ARE CONSIDERED A PART OF THIS DETAIL.
3. ANY CARPENTRY OR METAL WORK SHOULD BE DESIGNED AND CONSTRUCTED IN ACCORDANCE WITH LOCAL CODE REQUIREMENTS AND/OR PROJECT SPECS. THESE COMPONENTS SHOULD BE REVIEWED AND APPROVED BY A LICENSED DESIGN PROFESSIONAL.
4. JM TPO EDGE SEALANT IS REQUIRED ON ALL CUT OR NON-ENCAPSULATED EDGES OF REINFORCED MEMBRANE. THIS INCLUDES FACTORY CUT MEMBRANE (SEE DETAIL T-MS-01).
5. FOR JM APPROVED BASE FLASHING FASTENING METHODS SEE T-FW-B DETAILS. A SUFFICIENT BACKER FASTENING STRIP MUST BE INSTALLED BEHIND SUBSTRATES DIRECTLY TO STUDS FOR INSTALLATION OF TERMINATION BARS AND FLASHINGS WHEN SUBSTRATES WILL NOT SUPPORT A PROPER, SECURE INSTALLATION. SEE DETAIL T-FW-M2I FOR BACKER DETAIL.
6. FOR JM APPROVED INTERMEDIATE FLASHING FASTENING METHODS SEE T-FW-I DETAILS. MINIMUM FLASHING TERMINATION HEIGHT IS 8" (203 mm) ABOVE ROOF SURFACE. INTERMEDIATE ADHERED MEMBRANE FASTENING REQUIRED AT 5'-0" (1.52 m) INTERVALS MAXIMUM, AND 18" (457 mm) HIGH MAXIMUM FOR NON ADHERED MEMBRANE ON CMU, BRICK, SMOOTH CONCRETE WALLS, OR ANY JM APPROVED SUBSTRATE, I.E. PLYWOOD, SECUROCK®GYPSUM-FIBER AND DENSDECK. SEE DETAIL T-FW-M2I FOR JM APPROVED FASTENING METHODS.
7. FOR JM APPROVED TOP OF WALL FLASHING METHODS SEE T-FW-T DETAILS.
8. JM APPROVED ADHESIVES FOR USE ON VERTICAL FLASHING APPLICATIONS INCLUDES JM TPO MEMBRANE ADHESIVE (LOW VOC OR SOLVENT BASED OR JM TPO WATER BASED MEMBRANE ADHESIVE).

Johns Manville is a manufacturer of commercial roofing products and offers this general conceptual information to you as a courtesy. This complimentary assistance is not to be used or relied upon by anyone as a substitute for professional engineering design and documentation required by building code, contract, or applicable law. By accepting these comments you agree they do not constitute any representations, endorsements of, or an assumption by Johns Manville of any liability for either the adequacy of design of this building or any other material not supplied by Johns Manville.

**Note:** For the most current information on general guidelines, please refer to the System Considerations tab under Commercial Roofing Products on the JM Roofing Web site. For specifications, flashing details and general installation information please refer to the Application Tools tab.

Refer to the Safe Use Instructions and product label prior to using this product.



## TPO Base & Wall Flashing with Coping Isometric View Master Detail

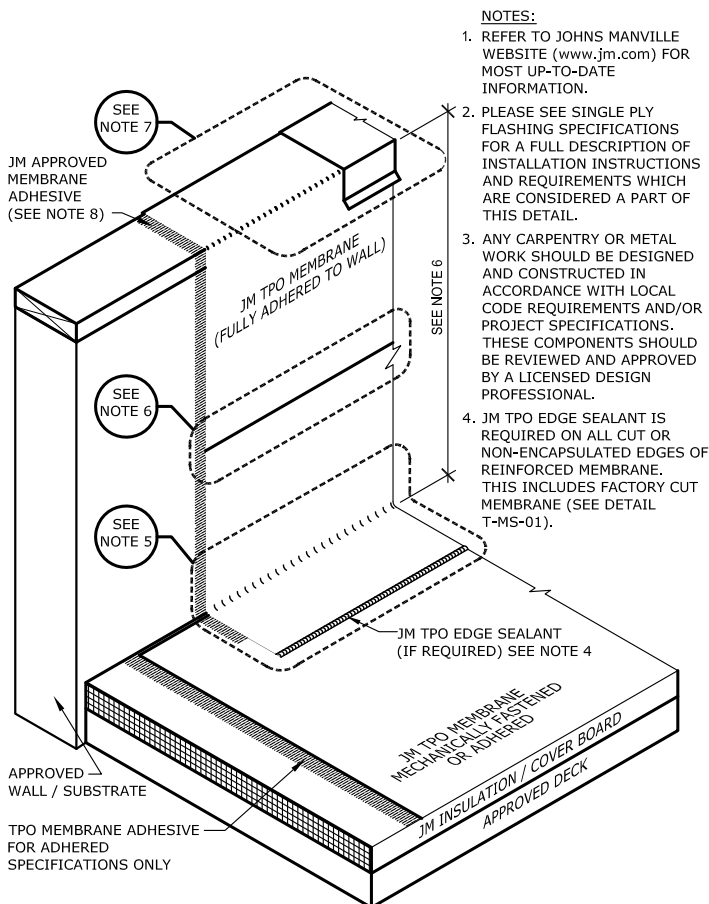

### NOTES:

1. REFER TO JOHNS MANVILLE WEBSITE ([www.jm.com](http://www.jm.com)) FOR MOST UP-TO-DATE INFORMATION.
2. PLEASE SEE SINGLE PLY FLASHING SPECIFICATIONS FOR A FULL DESCRIPTION OF INSTALLATION INSTRUCTIONS AND REQUIREMENTS WHICH ARE CONSIDERED A PART OF THIS DETAIL.
3. ANY CARPENTRY OR METAL WORK SHOULD BE DESIGNED AND CONSTRUCTED IN ACCORDANCE WITH LOCAL CODE REQUIREMENTS AND/OR PROJECT SPECIFICATIONS. THESE COMPONENTS SHOULD BE REVIEWED AND APPROVED BY A LICENSED DESIGN PROFESSIONAL.
4. JM TPO EDGE SEALANT IS REQUIRED ON ALL CUT OR NON-ENCAPSULATED EDGES OF REINFORCED MEMBRANE. THIS INCLUDES FACTORY CUT MEMBRANE (SEE DETAIL T-MS-01).

### NOTES CONTINUED:

5. FOR JM APPROVED BASE FLASHING FASTENING METHODS SEE T-FW-B DETAILS. A SUFFICIENT BACKER FASTENING STRIP MUST BE INSTALLED BEHIND SUBSTRATES DIRECTLY TO STUDS FOR INSTALLATION OF TERMINATION BARS AND FLASHINGS WHEN SUBSTRATES WILL NOT SUPPORT A PROPER, SECURE INSTALLATION. SEE DETAIL T-FW-M21 FOR BACKER DETAIL.
6. FOR JM APPROVED INTERMEDIATE FLASHING FASTENING METHODS SEE T-FW-I DETAILS. MINIMUM FLASHING TERMINATION HEIGHT IS 8" (203 mm) ABOVE ROOF SURFACE. INTERMEDIATE ADHERED MEMBRANE FASTENING REQUIRED AT 5'-0" (1.52 m) INTERVALS MAXIMUM, AND 18" (457 mm) HIGH MAXIMUM FOR NON ADHERED MEMBRANE ON CMU, BRICK, SMOOTH CONCRETE WALLS, OR ANY JM APPROVED SUBSTRATE, I.E. PLYWOOD, SECUROCK® GYPSUM-FIBER AND DENSDECK® SEE DETAIL T-FW-M21 FOR JM APPROVED FASTENING METHODS.
7. FOR JM APPROVED TOP OF WALL FLASHING METHODS SEE T-FW-T DETAILS.
8. JM APPROVED ADHESIVES FOR USE ON VERTICAL FLASHING APPLICATIONS INCLUDES JM TPO MEMBRANE ADHESIVES (LOW VOC OR SOLVENT BASED OR JM TPO WATER BASED MEMBRANE ADHESIVE).

Johns Manville is a manufacturer of commercial roofing products and offers this general conceptual information to you as a courtesy. This complimentary assistance is not to be used or relied upon by anyone as a substitute for professional engineering design and documentation required by building code, contract, or applicable law. By accepting these comments you agree they do not constitute any representations, endorsements of, or an assumption by Johns Manville of any liability for either the adequacy of design of this building or any other material not supplied by Johns Manville.

**Note:** For the most current information on general guidelines, please refer to the System Considerations tab under Commercial Roofing Products on the JM Roofing Web site. For specifications, flashing details and general installation information please refer to the Application Tools tab.

Refer to the Safe Use Instructions and product label prior to using this product.



## Highwall Flashing with Metal Backing Strip Isometric View Master Detail

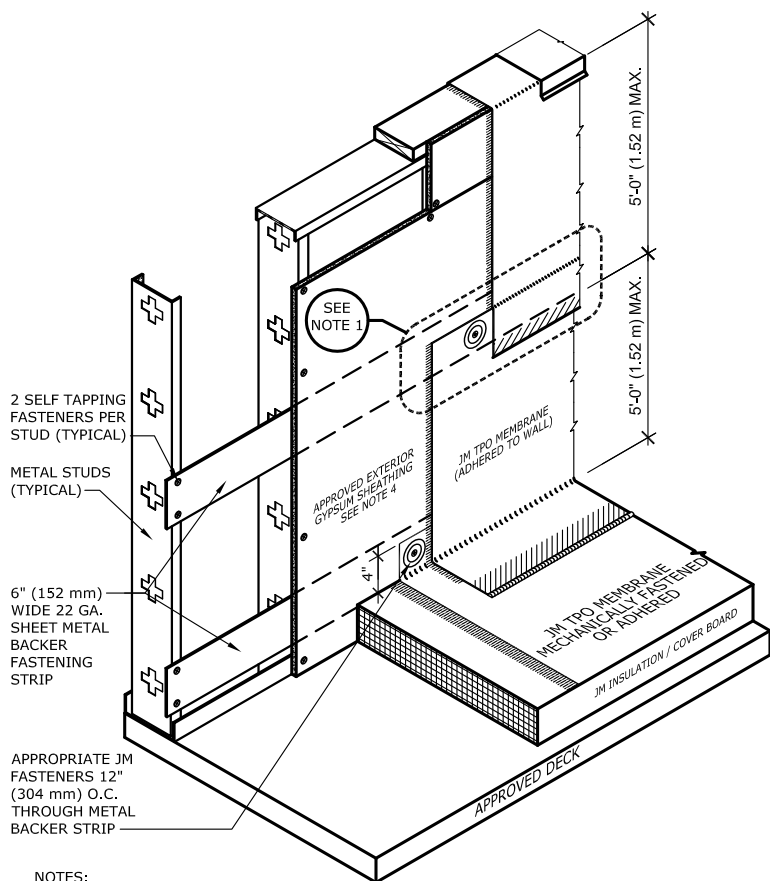

### NOTES:

1. FOR JM APPROVED INTERMEDIATE FLASHING FASTENING METHODS SEE T-FW-I DETAILS. MINIMUM FLASHING TERMINATION HEIGHT IS 8" (203 mm) ABOVE ROOF SURFACE. INTERMEDIATE ADHERED MEMBRANE FASTENING REQUIRED AT 5'-0" (1.52 m) INTERVALS MAXIMUM, AND 18" (457 mm) HIGH MAXIMUM FOR NON ADHERED MEMBRANE ON CMU, BRICK, SMOOTH CONCRETE WALLS, OR ANY JM APPROVED SUBSTRATE, I.E. PLYWOOD, SECUROCK<sup>®</sup> GYPSUM-FIBER AND DENSEDECK<sup>®</sup> SEE DETAIL T-FW-M1 FOR JM APPROVED FASTENING METHODS.
2. FOR JM APPROVED BASE FLASHING FASTENING METHODS SEE T-FW-B DETAILS. A SUFFICIENT BACKER FASTENING STRIP MUST BE INSTALLED BEHIND SUBSTRATES DIRECTLY TO STUDS FOR INSTALLATION OF TERMINATION BARS AND FLASHINGS WHEN SUBSTRATES WILL NOT SUPPORT A PROPER, SECURE INSTALLATION. SEE DETAIL T-FW-M2I FOR BACKER DETAIL.
3. FOR JM APPROVED TOP OF WALL FLASHING METHODS SEE T-FW-T DETAILS.
4. APPROVED EXTERIOR GYPSUM SHEATHING FOR ROOF FLASHING APPLICATION INCLUDE SECUROCK GYPSUM-FIBER AND DENSEDECK.

Johns Manville is a manufacturer of commercial roofing products and offers this general conceptual information to you as a courtesy. This complimentary assistance is not to be used or relied upon by anyone as a substitute for professional engineering design and documentation required by building code, contract, or applicable law. By accepting these comments you agree they do not constitute any representations, endorsements of, or an assumption by Johns Manville of any liability for either the adequacy of design of this building or any other material not supplied by Johns Manville.

**Note:** For the most current information on general guidelines, please refer to the System Considerations tab under Commercial Roofing Products on the JM Roofing Web site. For specifications, flashing details and general installation information please refer to the Application Tools tab.

Refer to the Safe Use Instructions and product label prior to using this product.



## Self-Adhered TPO Base & Wall Flashing with Coping Isometric View

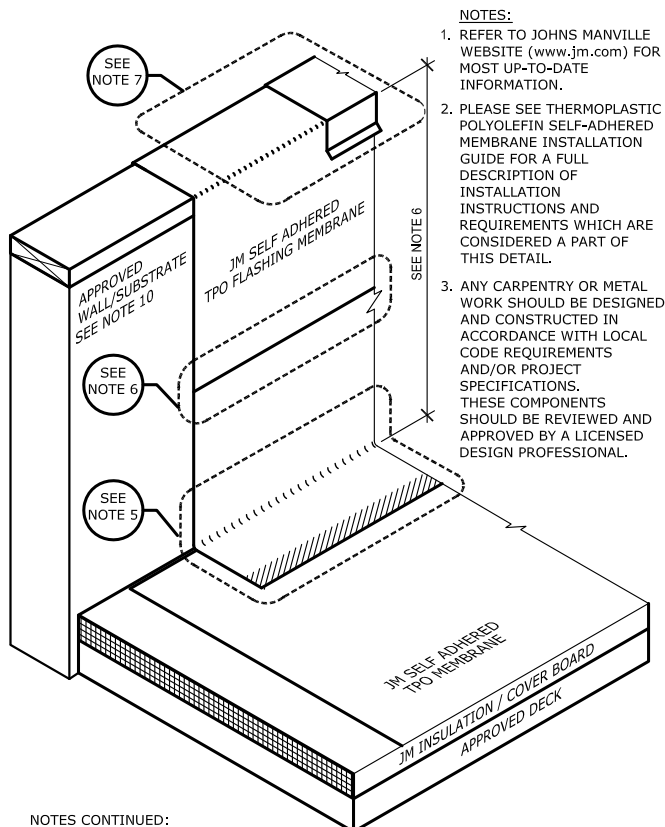

### NOTES:

1. REFER TO JOHNS MANVILLE WEBSITE ([www.jm.com](http://www.jm.com)) FOR MOST UP-TO-DATE INFORMATION.
2. PLEASE SEE THERMOPLASTIC POLYOLEFIN SELF-ADHERED MEMBRANE INSTALLATION GUIDE FOR A FULL DESCRIPTION OF INSTALLATION INSTRUCTIONS AND REQUIREMENTS WHICH ARE CONSIDERED A PART OF THIS DETAIL.
3. ANY CARPENTRY OR METAL WORK SHOULD BE DESIGNED AND CONSTRUCTED IN ACCORDANCE WITH LOCAL CODE REQUIREMENTS AND/OR PROJECT SPECIFICATIONS. THESE COMPONENTS SHOULD BE REVIEWED AND APPROVED BY A LICENSED DESIGN PROFESSIONAL.

### NOTES CONTINUED:

4. JM TPO EDGE SEALANT IS REQUIRED ON ALL CUT OR NON-ENCAPSULATED EDGES OF REINFORCED MEMBRANE. THIS INCLUDES FACTORY CUT MEMBRANE (SEE DETAIL T-MS-01).
5. FOR JM APPROVED BASE FLASHING FASTENING METHODS SEE DETAILS T-FW-B9, B10, B11, B12. A SUFFICIENT BACKER FASTENING STRIP MUST BE INSTALLED BEHIND SUBSTRATES DIRECTLY TO STUDS FOR INSTALLATION OF TERMINATION BARS AND FLASHINGS WHEN SUBSTRATES WILL NOT SUPPORT A PROPER, SECURE INSTALLATION. SEE DETAIL T-FW-M2I FOR BACKER DETAIL.
6. FOR JM APPROVED INTERMEDIATE FLASHING FASTENING METHODS SEE T-FW-I DETAILS. MINIMUM FLASHING TERMINATION HEIGHT IS 8" (203 mm) ABOVE ROOF SURFACE. INTERMEDIATE SELF ADHERED MEMBRANE FASTENING REQUIRED AT 5'-0" (1.52 m) INTERVALS MAXIMUM.
7. FOR JM APPROVED TOP OF WALL FLASHING METHODS SEE T-FW-T DETAILS.
8. JM TPO REINFORCED TERMINATION STRIP (RTS) IS NOT ACCEPTABLE FOR USE WITH JM SELF ADHERED TPO MEMBRANE.
9. ALWAYS PRIME POROUS SURFACES WITH JM SA PRIMER OR JM SA LVOC PRIMER PRIOR TO INSTALLING JM TPO SA FLASHING MEMBRANE. PRIME SMOOTH SURFACES WITH JM SA PRIMER OR JM SA LVOC PRIMER WHEN TEMPERATURES ARE BETWEEN 20° F AND 40° F. JM SELF ADHERED TPO MEMBRANE IS NOT TO BE INSTALLED WHEN TEMPERATURE IS BELOW 20 DEGREES.
10. APPROVED SUBSTRATES FOR THE APPLICATION OF JM TPO-SA FLASHING MEMBRANE ARE GYPSUM, CONCRETE, FIBER CEMENT AND WOOD.

Johns Manville is a manufacturer of commercial roofing products and offers this general conceptual information to you as a courtesy. This complimentary assistance is not to be used or relied upon by anyone as a substitute for professional engineering design and documentation required by building code, contract, or applicable law. By accepting these comments you agree they do not constitute any representations, endorsements of, or an assumption by Johns Manville of any liability for either the adequacy of design of this building or any other material not supplied by Johns Manville.

**Note:** For the most current information on general guidelines, please refer to the System Considerations tab under Commercial Roofing Products on the JM Roofing Web site. For specifications, flashing details and general installation information please refer to the Application Tools tab.

Refer to the Safe Use Instructions and product label prior to using this product.



## TPO Membrane Mechanically Fastened with RhinoPlates Master Detail

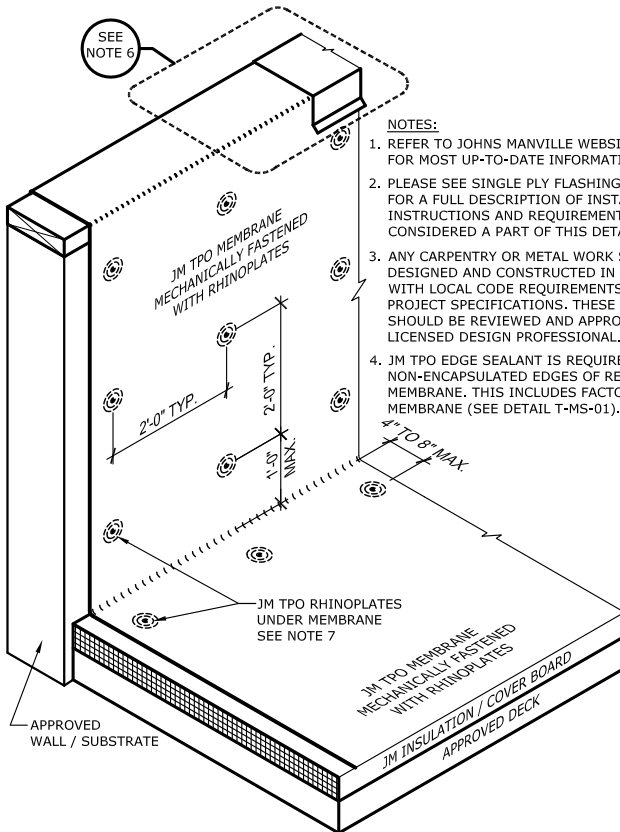

**NOTES:**

1. REFER TO JOHNS MANVILLE WEBSITE ([www.jm.com](http://www.jm.com)) FOR MOST UP-TO-DATE INFORMATION.
2. PLEASE SEE SINGLE PLY FLASHING SPECIFICATIONS FOR A FULL DESCRIPTION OF INSTALLATION INSTRUCTIONS AND REQUIREMENTS WHICH ARE CONSIDERED A PART OF THIS DETAIL.
3. ANY CARPENTRY OR METAL WORK SHOULD BE DESIGNED AND CONSTRUCTED IN ACCORDANCE WITH LOCAL CODE REQUIREMENTS AND/OR PROJECT SPECIFICATIONS. THESE COMPONENTS SHOULD BE REVIEWED AND APPROVED BY A LICENSED DESIGN PROFESSIONAL.
4. JM TPO EDGE SEALANT IS REQUIRED ON ALL CUT OR NON-ENCAPSULATED EDGES OF REINFORCED MEMBRANE. THIS INCLUDES FACTORY CUT MEMBRANE (SEE DETAIL T-MS-01).

5. SEE DETAIL T-FW-B6 FOR RHINOBOND BASE FLASHING DETAIL. APPROPRIATE SUBSTRATES FOR VERTICAL RHINOBOND APPLICATION INCLUDES PLYWOOD, OSB, METAL STUD WALLS WITH APPROVED SHEATHING.
6. FOR JM APPROVED TOP OF WALL FLASHING METHODS SEE T-FW-T DETAILS.
7. TPO MEMBRANE IS SECURED TO RHINOPLATES USING THE INDUCTION WELDER. SEE THE TPO RHINOPLATE SYSTEM APPLICATION GUIDE FOR FURTHER INFORMATION.
8. TPO RHINOPLATE APPLICATION IS ONLY APPROVED FOR 60 MIL OR THICKER MEMBRANES.

Johns Manville is a manufacturer of commercial roofing products and offers this general conceptual information to you as a courtesy. This complimentary assistance is not to be used or relied upon by anyone as a substitute for professional engineering design and documentation required by building code, contract, or applicable law. By accepting these comments you agree they do not constitute any representations, endorsements of, or an assumption by Johns Manville of any liability for either the adequacy of design of this building or any other material not supplied by Johns Manville.

**Note:** For the most current information on general guidelines, please refer to the System Considerations tab under Commercial Roofing Products on the JM Roofing Web site. For specifications, flashing details and general installation information please refer to the Application Tools tab.

Refer to the Safe Use Instructions and product label prior to using this product.



## TPO Rhinoplasts on Vertical Surface Wall Flashing Isometric View

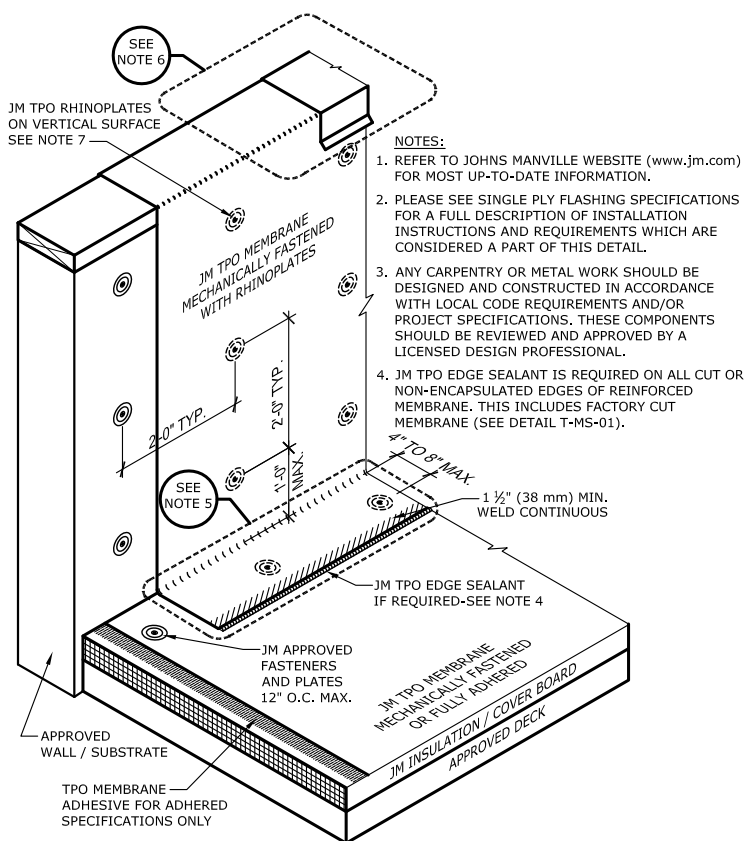

1. REFER TO JOHNS MANVILLE WEBSITE ([www.jm.com](http://www.jm.com)) FOR MOST UP-TO-DATE INFORMATION.
2. PLEASE SEE SINGLE PLY FLASHING SPECIFICATIONS FOR A FULL DESCRIPTION OF INSTALLATION INSTRUCTIONS AND REQUIREMENTS WHICH ARE CONSIDERED A PART OF THIS DETAIL.
3. ANY CARPENTRY OR METAL WORK SHOULD BE DESIGNED AND CONSTRUCTED IN ACCORDANCE WITH LOCAL CODE REQUIREMENTS AND/OR PROJECT SPECIFICATIONS. THESE COMPONENTS SHOULD BE REVIEWED AND APPROVED BY A LICENSED DESIGN PROFESSIONAL.
4. JM TPO EDGE SEALANT IS REQUIRED ON ALL CUT OR NON-ENCAPSULATED EDGES OF REINFORCED MEMBRANE. THIS INCLUDES FACTORY CUT MEMBRANE (SEE DETAIL T-MS-01).
5. FOR JM APPROVED BASE FLASHING FASTENING METHODS SEE T-FW-B DETAILS. APPROPRIATE SUBSTRATES FOR VERTICAL RHINOPLATE APPLICATION INCLUDES PLYWOOD, OSB, METAL STUD WALLS WITH APPROVED SHEATHING.
6. FOR JM APPROVED TOP OF WALL FLASHING METHODS SEE T-FW-T DETAILS.
7. TPO MEMBRANE IS SECURED TO RHINOPLATES USING THE INDUCTION WELDER. SEE THE TPO RHINOPLATE SYSTEM APPLICATION GUIDE FOR FURTHER INFORMATION.
8. TPO RHINOPLATE APPLICATION IS ONLY APPROVED FOR 60 MIL OR THICKER MEMBRANES.

Johns Manville is a manufacturer of commercial roofing products and offers this general conceptual information to you as a courtesy. This complimentary assistance is not to be used or relied upon by anyone as a substitute for professional engineering design and documentation required by building code, contract, or applicable law. By accepting these comments you agree they do not constitute any representations, endorsements of, or an assumption by Johns Manville of any liability for either the adequacy of design of this building or any other material not supplied by Johns Manville.

**Note:** For the most current information on general guidelines, please refer to the System Considerations tab under Commercial Roofing Products on the JM Roofing Web site. For specifications, flashing details and general installation information please refer to the Application Tools tab.

Refer to the Safe Use Instructions and product label prior to using this product.





## Base Flashing with Horizontal Termination Strip (RTS)

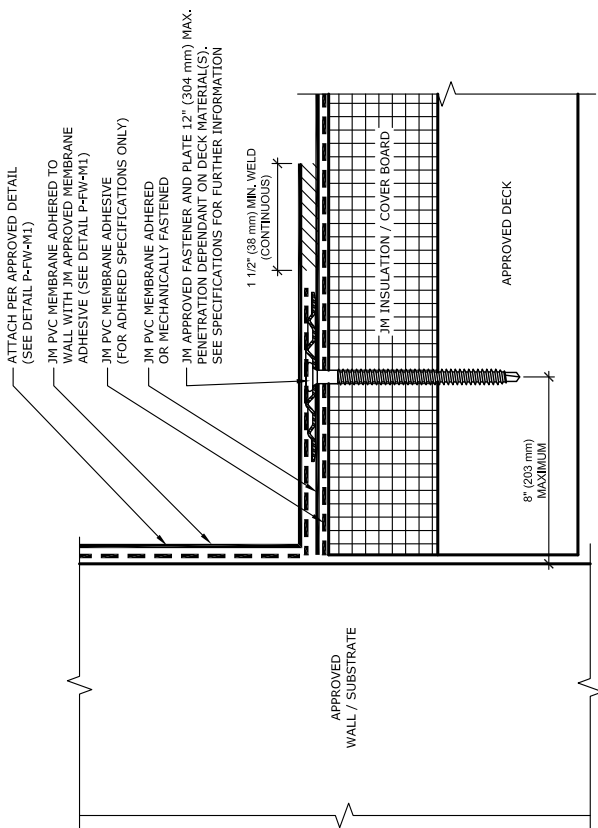

**NOTES:**

1. REFER TO JOHNS MANVILLE WEBSITE ([www.jm.com](http://www.jm.com)) FOR MOST UP-TO-DATE INFORMATION.
2. PLEASE SEE SINGLE PLY FLASHING SPECIFICATIONS FOR A FULL DESCRIPTION OF INSTALLATION INSTRUCTIONS AND REQUIREMENTS WHICH ARE CONSIDERED A PART OF THIS DETAIL.
3. ANY CARPENTRY OR METAL WORK SHOULD BE DESIGNED AND CONSTRUCTED IN ACCORDANCE WITH LOCAL CODE REQUIREMENTS AND/OR PROJECT SPECIFICATIONS. THESE COMPONENTS SHOULD BE REVIEWED AND APPROVED BY A LICENSED DESIGN PROFESSIONAL.
4. THIS DETAIL IS ALSO SUITABLE FOR TERMINATION OF FLEECE BACKED MEMBRANES. NON FLEECE BACK MEMBRANE IS REQUIRED FOR WALL FLASHINGS.

### Maximum Guarantee Term: 30 Year

Johns Manville is a manufacturer of commercial roofing products and offers this general conceptual information to you as a courtesy. This complimentary assistance is not to be used or relied upon by anyone as a substitute for professional engineering design and documentation required by building code, contract, or applicable law. By accepting these comments you agree they do not constitute any representations, endorsements of, or an assumption by Johns Manville of any liability for either the adequacy of design of this building or any other material not supplied by Johns Manville.

**Note:** For the most current information on general guidelines, please refer to the System Considerations tab under Commercial Roofing Products on the JM Roofing Web site. For specifications, flashing details and general installation information please refer to the Application Tools tab.

Refer to the Safe Use Instructions and product label prior to using this product.



## Base Flashing with Vertical Termination Strip (RTS)

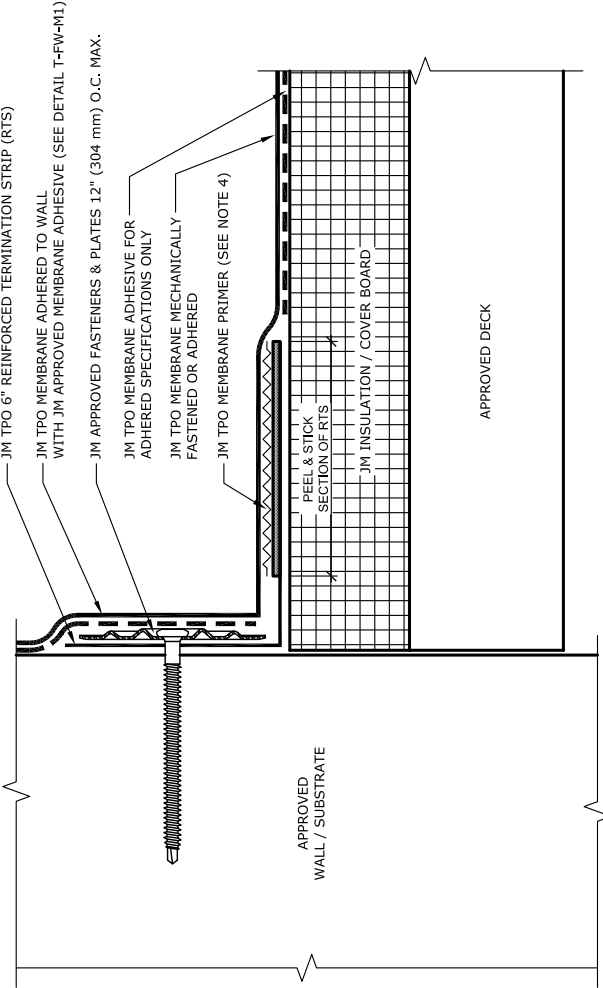

### NOTES:

1. REFER TO JOHNS MANVILLE WEBSITE ([www.jm.com](http://www.jm.com)) FOR MOST UP-TO-DATE INFORMATION.
2. PLEASE SEE SINGLE PLY FLASHING SPECIFICATIONS FOR A FULL DESCRIPTION OF INSTALLATION INSTRUCTIONS AND REQUIREMENTS WHICH ARE CONSIDERED A PART OF THIS DETAIL.
3. ANY CARPENTRY OR METAL WORK SHOULD BE DESIGNED AND CONSTRUCTED IN ACCORDANCE WITH LOCAL CODE REQUIREMENTS AND/OR PROJECT SPECIFICATIONS. THESE COMPONENTS SHOULD BE REVIEWED AND APPROVED BY A LICENSED DESIGN PROFESSIONAL.
4. PRIME UNDERSIDE OF FIELD MEMBRANE AT PEEL & STICK SECTION WITH JM TPO MEMBRANE PRIMER. ROLL TPO MEMBRANE WITH ROLLER UNDER PRESSURE AT PEEL & STICK SECTION OF RTS.

## Maximum Guarantee Term: 30 Year

Johns Manville is a manufacturer of commercial roofing products and offers this general conceptual information to you as a courtesy. This complimentary assistance is not to be used or relied upon by anyone as a substitute for professional engineering design and documentation required by building code, contract, or applicable law. By accepting these comments you agree they do not constitute any representations, endorsements of, or an assumption by Johns Manville of any liability for either the adequacy of design of this building or any other material not supplied by Johns Manville.

**Note:** For the most current information on general guidelines, please refer to the System Considerations tab under Commercial Roofing Products on the JM Roofing Web site. For specifications, flashing details and general installation information please refer to the Application Tools tab.

Refer to the Safe Use Instructions and product label prior to using this product.



## Base Tie-In (Fastener & Plate)

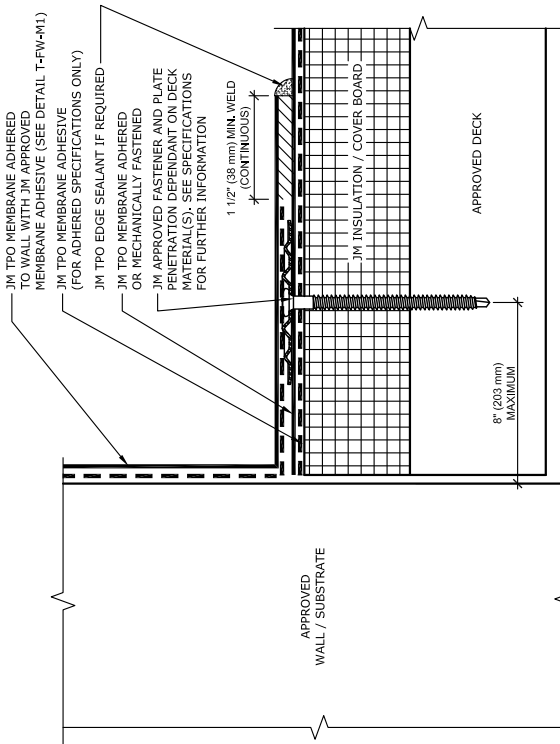

**NOTES:**

1. REFER TO JOHNS MANVILLE WEBSITE ([www.jm.com](http://www.jm.com)) FOR MOST UP-TO-DATE INFORMATION.
2. PLEASE SEE SINGLE PLY FLASHING SPECIFICATIONS FOR A FULL DESCRIPTION OF INSTALLATION INSTRUCTIONS AND REQUIREMENTS WHICH ARE CONSIDERED A PART OF THIS DETAIL.
3. ANY CARPENTRY OR METAL WORK SHOULD BE DESIGNED AND CONSTRUCTED IN ACCORDANCE WITH LOCAL CODE REQUIREMENTS AND/OR PROJECT SPECIFICATIONS. THESE COMPONENTS SHOULD BE REVIEWED AND APPROVED BY A LICENSED DESIGN PROFESSIONAL.
4. JM TPO EDGE SEALANT IS REQUIRED ON ALL CUT OR NON-ENCAPSULATED EDGES OF REINFORCED MEMBRANE. THIS INCLUDES FACTORY CUT MEMBRANE (SEE DETAIL T-MS-01).
5. THIS DETAIL IS ALSO SUITABLE FOR TERMINATION OF FLEECE BACKED MEMBRANES. NON FLEECE BACK MEMBRANE IS REQUIRED FOR WALL FLASHINGS.

## Maximum Guarantee Term: 30 Year

Johns Manville is a manufacturer of commercial roofing products and offers this general conceptual information to you as a courtesy. This complimentary assistance is not to be used or relied upon by anyone as a substitute for professional engineering design and documentation required by building code, contract, or applicable law. By accepting these comments you agree they do not constitute any representations, endorsements of, or an assumption by Johns Manville of any liability for either the adequacy of design of this building or any other material not supplied by Johns Manville.

**Note:** For the most current information on general guidelines, please refer to the System Considerations tab under Commercial Roofing Products on the JM Roofing Web site. For specifications, flashing details and general installation information please refer to the Application Tools tab.

Refer to the Safe Use Instructions and product label prior to using this product.



## Base Tie-In (Fastener & Plate) on Wall

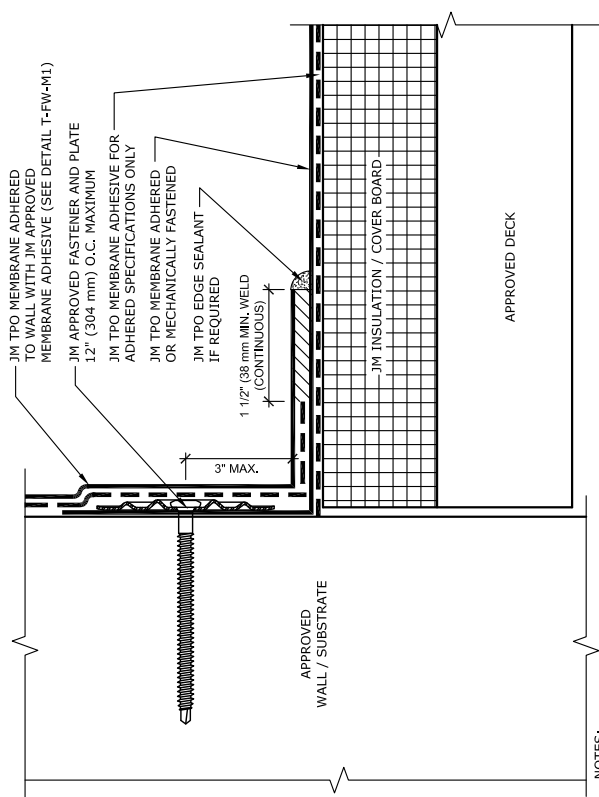

**NOTES:**

1. REFER TO JOHNS MANVILLE WEBSITE ([www.jm.com](http://www.jm.com)) FOR MOST UP-TO-DATE INFORMATION.
2. PLEASE SEE SINGLE PLY FLASHING SPECIFICATIONS FOR A FULL DESCRIPTION OF INSTALLATION INSTRUCTIONS AND REQUIREMENTS WHICH ARE CONSIDERED A PART OF THIS DETAIL.
3. ANY CARPENTRY OR METAL WORK SHOULD BE DESIGNED AND CONSTRUCTED IN ACCORDANCE WITH LOCAL CODE REQUIREMENTS AND/OR PROJECT SPECIFICATIONS; THESE COMPONENTS SHOULD BE REVIEWED AND APPROVED BY A LICENSED DESIGN PROFESSIONAL.
4. JM TPO EDGE SEALANT IS REQUIRED ON ALL CUT OR NON-ENCAPSULATED EDGES OF REINFORCED MEMBRANE. THIS INCLUDES FACTORY CUT MEMBRANE (SEE DETAIL T-MS-01).
5. THIS DETAIL IS ALSO SUITABLE FOR TERMINATION OF FLEECE BACKED MEMBRANE. NON FLEECE BACK MEMBRANE IS REQUIRED FOR WALL FLASHINGS.

### Maximum Guarantee Term: 30 Year

Johns Manville is a manufacturer of commercial roofing products and offers this general conceptual information to you as a courtesy. This complimentary assistance is not to be used or relied upon by anyone as a substitute for professional engineering design and documentation required by building code, contract, or applicable law. By accepting these comments you agree they do not constitute any representations, endorsements of, or an assumption by Johns Manville of any liability for either the adequacy of design of this building or any other material not supplied by Johns Manville.

**Note:** For the most current information on general guidelines, please refer to the System Considerations tab under Commercial Roofing Products on the JM Roofing Web site. For specifications, flashing details and general installation information please refer to the Application Tools tab.

Refer to the Safe Use Instructions and product label prior to using this product.



## Membrane Flashing Base Tie-In (High Internal Pressure)

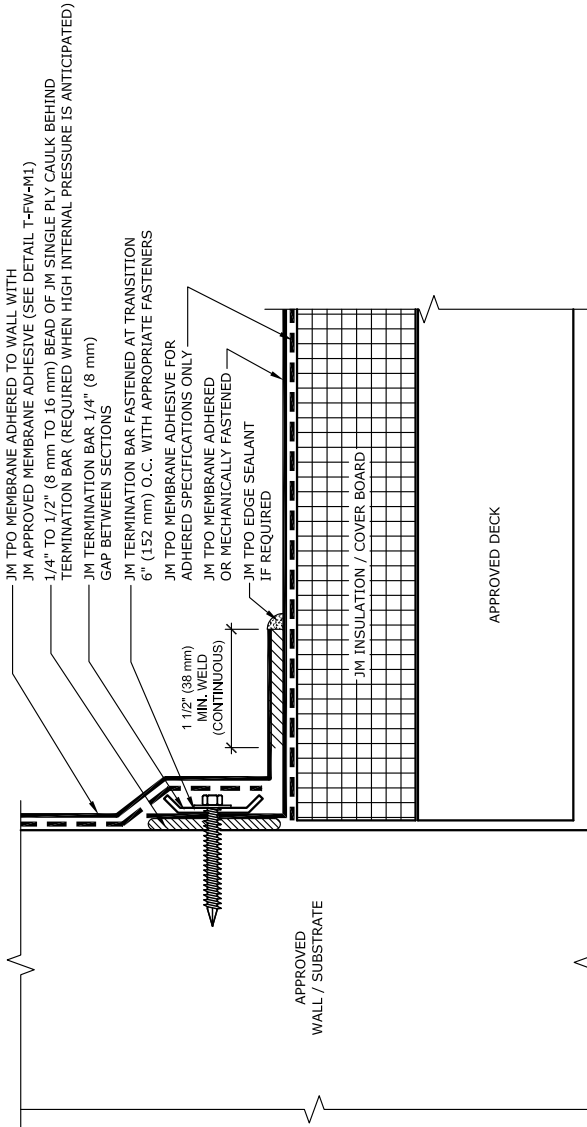

**NOTES:**

1. REFER TO JOHNS MANVILLE WEBSITE ([www.jm.com](http://www.jm.com)) FOR MOST UP-TO-DATE INFORMATION.
2. PLEASE SEE SINGLE PLY FLASHING SPECIFICATIONS FOR A FULL DESCRIPTION OF INSTALLATION INSTRUCTIONS AND REQUIREMENTS WHICH ARE CONSIDERED A PART OF THIS DETAIL.
3. ANY CARPENTRY OR METAL WORK SHOULD BE DESIGNED AND CONSTRUCTED IN ACCORDANCE WITH LOCAL CODE REQUIREMENTS AND/OR PROJECT SPECIFICATIONS. THESE COMPONENTS SHOULD BE REVIEWED AND APPROVED BY A LICENSED DESIGN PROFESSIONAL.
4. JM TPO EDGE SEALANT IS REQUIRED ON ALL CUT OR NON-ENCAPSULATED EDGES OF REINFORCED MEMBRANE. THIS INCLUDES FACTORY CUT MEMBRANE (SEE DETAIL T-MS-01).
5. THIS DETAIL IS ALSO SUITABLE FOR TERMINATION OF FLEECE BACKED MEMBRANES. NON FLEECE BACK MEMBRANE IS REQUIRED FOR WALL FLASHINGS.

### Maximum Guarantee Term: 30 Year

Johns Manville is a manufacturer of commercial roofing products and offers this general conceptual information to you as a courtesy. This complimentary assistance is not to be used or relied upon by anyone as a substitute for professional engineering design and documentation required by building code, contract, or applicable law. By accepting these comments you agree they do not constitute any representations, endorsements of, or an assumption by Johns Manville of any liability for either the adequacy of design of this building or any other material not supplied by Johns Manville.

**Note:** For the most current information on general guidelines, please refer to the System Considerations tab under Commercial Roofing Products on the JM Roofing Web site. For specifications, flashing details and general installation information please refer to the Application Tools tab.

Refer to the Safe Use Instructions and product label prior to using this product.



## Base Tie-In (Rhino Plate System)

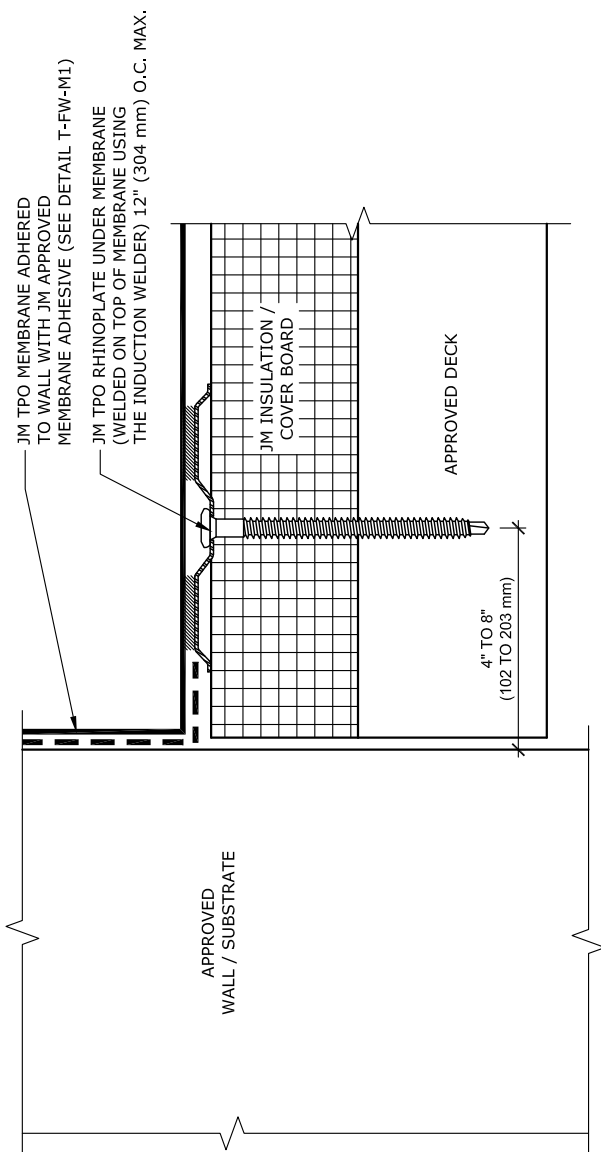

**NOTES:**

1. REFER TO JOHNS MANVILLE WEBSITE ([www.jm.com](http://www.jm.com)) FOR MOST UP-TO-DATE INFORMATION.
2. PLEASE SEE SINGLE PLY FLASHING SPECIFICATIONS FOR A FULL DESCRIPTION OF INSTALLATION INSTRUCTIONS AND REQUIREMENTS WHICH ARE CONSIDERED A PART OF THIS DETAIL.
3. ANY CARPENTRY OR METAL WORK SHOULD BE DESIGNED AND CONSTRUCTED IN ACCORDANCE WITH LOCAL CODE REQUIREMENTS AND/OR PROJECT SPECIFICATIONS. THESE COMPONENTS SHOULD BE REVIEWED AND APPROVED BY A LICENSED DESIGN PROFESSIONAL.

### Maximum Guarantee Term: 20 Year

Johns Manville is a manufacturer of commercial roofing products and offers this general conceptual information to you as a courtesy. This complimentary assistance is not to be used or relied upon by anyone as a substitute for professional engineering design and documentation required by building code, contract, or applicable law. By accepting these comments you agree they do not constitute any representations, endorsements of, or an assumption by Johns Manville of any liability for either the adequacy of design of this building or any other material not supplied by Johns Manville.

**Note:** For the most current information on general guidelines, please refer to the System Considerations tab under Commercial Roofing Products on the JM Roofing Web site. For specifications, flashing details and general installation information please refer to the Application Tools tab.

Refer to the Safe Use Instructions and product label prior to using this product.



## Base Tie-In (Knee Wall Brace)

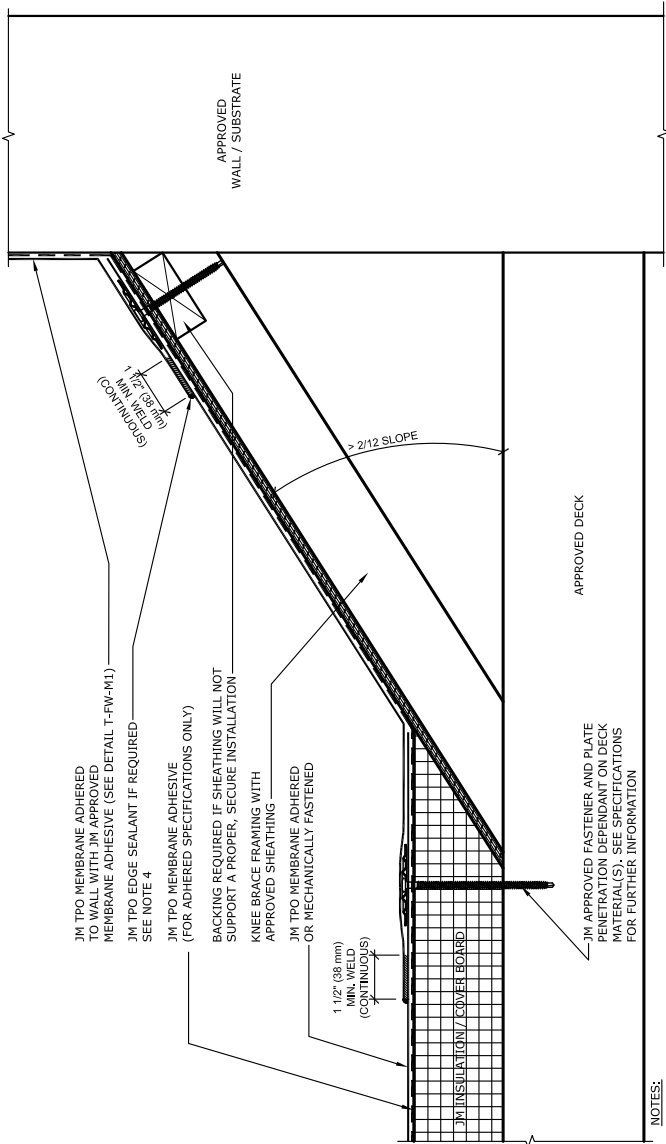

- NOTES:
1. REFER TO JOHNS MANVILLE WEBSITE ([www.jm.com](http://www.jm.com)) FOR MOST UP-TO-DATE INFORMATION.
  2. PLEASE SEE SINGLE PLY FLASHING SPECIFICATIONS FOR A FULL DESCRIPTION OF INSTALLATION INSTRUCTIONS AND REQUIREMENTS WHICH ARE CONSIDERED A PART OF THIS DETAIL.
  3. ANY CARPENTRY OR METAL WORK SHOULD BE DESIGNED AND CONSTRUCTED IN ACCORDANCE WITH LOCAL CODE REQUIREMENTS AND/OR PROJECT SPECIFICATIONS. THESE COMPONENTS SHOULD BE REVIEWED AND APPROVED BY A LICENSED DESIGN PROFESSIONAL.
  4. JM TPO EDGE SEALANT IS REQUIRED ON ALL CUT OR NON-ENCAPSULATED EDGES OF REINFORCED MEMBRANE. THIS INCLUDES FACTORY CUT MEMBRANE (SEE DETAIL T-MS-01).

### Maximum Guarantee Term: 30 Year

Johns Manville is a manufacturer of commercial roofing products and offers this general conceptual information to you as a courtesy. This complimentary assistance is not to be used or relied upon by anyone as a substitute for professional engineering design and documentation required by building code, contract, or applicable law. By accepting these comments you agree they do not constitute any representations, endorsements of, or an assumption by Johns Manville of any liability for either the adequacy of design of this building or any other material not supplied by Johns Manville.

**Note:** For the most current information on general guidelines, please refer to the System Considerations tab under Commercial Roofing Products on the JM Roofing Web site. For specifications, flashing details and general installation information please refer to the Application Tools tab.

Refer to the Safe Use Instructions and product label prior to using this product.



## Loose Hung Flashing

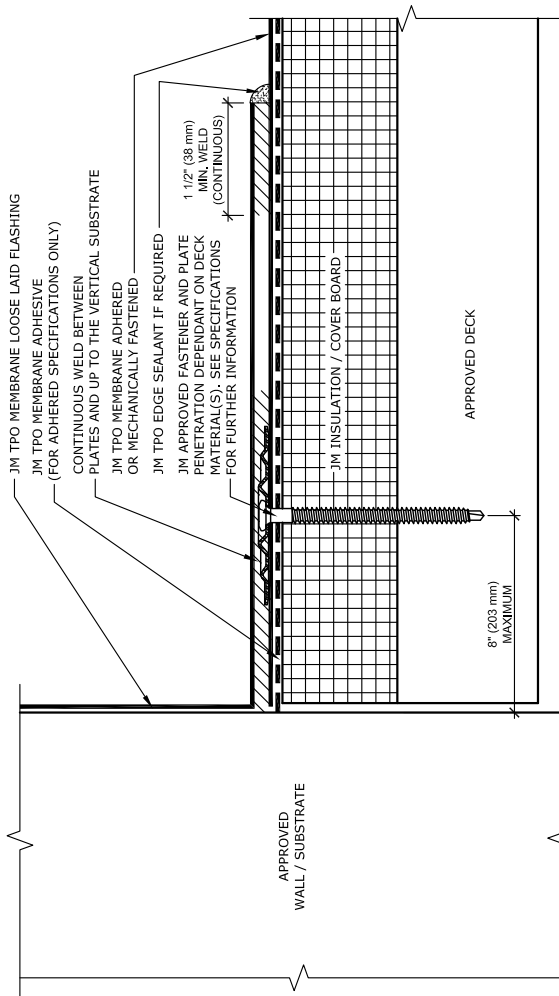

**NOTES:**

1. REFER TO JOHNS MANVILLE WEBSITE ([www.jm.com](http://www.jm.com)) FOR MOST UP-TO-DATE INFORMATION.
2. PLEASE SEE SINGLE PLY FLASHING SPECIFICATIONS FOR A FULL DESCRIPTION OF INSTALLATION INSTRUCTIONS AND REQUIREMENTS WHICH ARE CONSIDERED A PART OF THIS DETAIL.
3. ANY CARPENTRY OR METAL WORK SHOULD BE DESIGNED AND CONSTRUCTED IN ACCORDANCE WITH LOCAL CODE REQUIREMENTS AND/OR PROJECT SPECIFICATIONS. THESE COMPONENTS SHOULD BE REVIEWED AND APPROVED BY A LICENSED DESIGN PROFESSIONAL.
4. JM TPO EDGE SEALANT IS REQUIRED ON ALL CUT OR NON-ENCAPSULATED EDGES OF REINFORCED MEMBRANE. THIS INCLUDES FACTORY CUT MEMBRANE (SEE DETAIL T-MS-01).
5. THIS DETAIL IS ALSO SUITABLE FOR TERMINATION OF FLEECE BACKED MEMBRANES. NON FLEECE BACK MEMBRANE IS REQUIRED FOR WALL FLASHINGS.
6. MINIMUM FLASHING HEIGHT IS 8" (203 mm) ABOVE ROOF SURFACE. INTERMEDIATE FLASHING FASTENING HEIGHT FOR NON-ADHERED MEMBRANE IS 18" (457 mm) MAXIMUM AND AT 18" (457 mm) INTERVALS.

### Maximum Guarantee Term: 20 years

Johns Manville is a manufacturer of commercial roofing products and offers this general conceptual information to you as a courtesy. This complimentary assistance is not to be used or relied upon by anyone as a substitute for professional engineering design and documentation required by building code, contract, or applicable law. By accepting these comments you agree they do not constitute any representations, endorsements of, or an assumption by Johns Manville of any liability for either the adequacy of design of this building or any other material not supplied by Johns Manville.

**Note:** For the most current information on general guidelines, please refer to the System Considerations tab under Commercial Roofing Products on the JM Roofing Web site. For specifications, flashing details and general installation information please refer to the Application Tools tab.

Refer to the Safe Use Instructions and product label prior to using this product.





## TPO Self-Adhered Base Tie-In Fastener & Plate

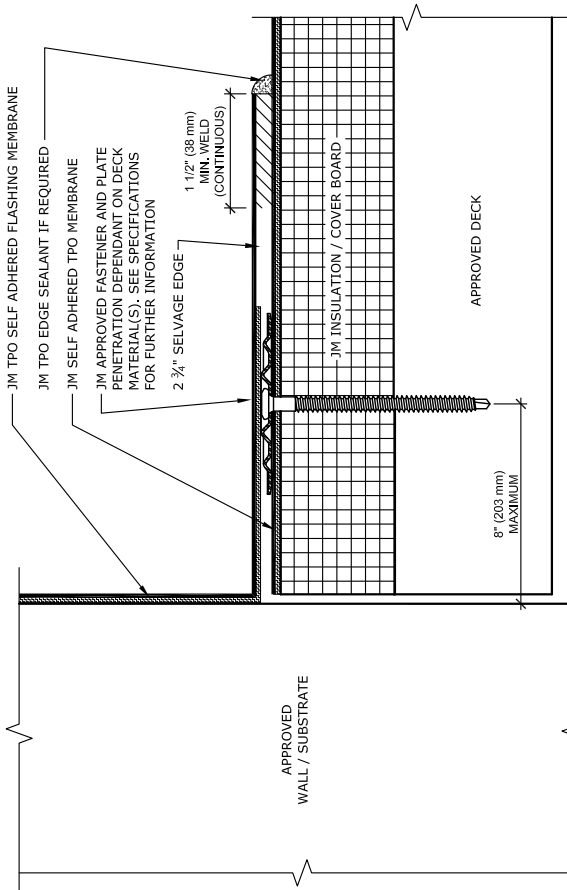

**NOTES:**

1. REFER TO JOHNS MANVILLE WEBSITE ([www.jm.com](http://www.jm.com)) FOR MOST UP-TO-DATE INFORMATION.
2. PLEASE SEE THERMOPLASTIC POLYOLEFIN SELF-ADHERED MEMBRANE INSTALLATION GUIDE FOR A FULL DESCRIPTION OF INSTALLATION INSTRUCTIONS AND REQUIREMENTS WHICH ARE CONSIDERED A PART OF THIS DETAIL.
3. ANY CARPENTRY OR METAL WORK SHOULD BE DESIGNED AND CONSTRUCTED IN ACCORDANCE WITH LOCAL CODE REQUIREMENTS AND/OR PROJECT SPECIFICATIONS. THESE COMPONENTS SHOULD BE REVIEWED AND APPROVED BY A LICENSED DESIGN PROFESSIONAL.
4. JM TPO EDGE SEALANT IS REQUIRED ON ALL CUT OR NON-ENCAPSULATED EDGES OF REINFORCED MEMBRANE. THIS INCLUDES FACTORY CUT MEMBRANE (SEE DETAIL T-MS-01).
5. THIS IS AN APPROVED BASE TIE-IN DETAIL FOR THE INSTALLATION OF JM TPO SELF ADHERED MEMBRANE. SEE MASTER DETAIL T-FW-M31.

### Maximum Guarantee Term: 20 Years

Johns Manville is a manufacturer of commercial roofing products and offers this general conceptual information to you as a courtesy. This complimentary assistance is not to be used or relied upon by anyone as a substitute for professional engineering design and documentation required by building code, contract, or applicable law. By accepting these comments you agree they do not constitute any representations, endorsements of, or an assumption by Johns Manville of any liability for either the adequacy of design of this building or any other material not supplied by Johns Manville.

**Note:** For the most current information on general guidelines, please refer to the System Considerations tab under Commercial Roofing Products on the JM Roofing Web site. For specifications, flashing details and general installation information please refer to the Application Tools tab.

Refer to the Safe Use Instructions and product label prior to using this product.



## TPO Self-Adhered Base Tie-In Fastener & Plate on Wall

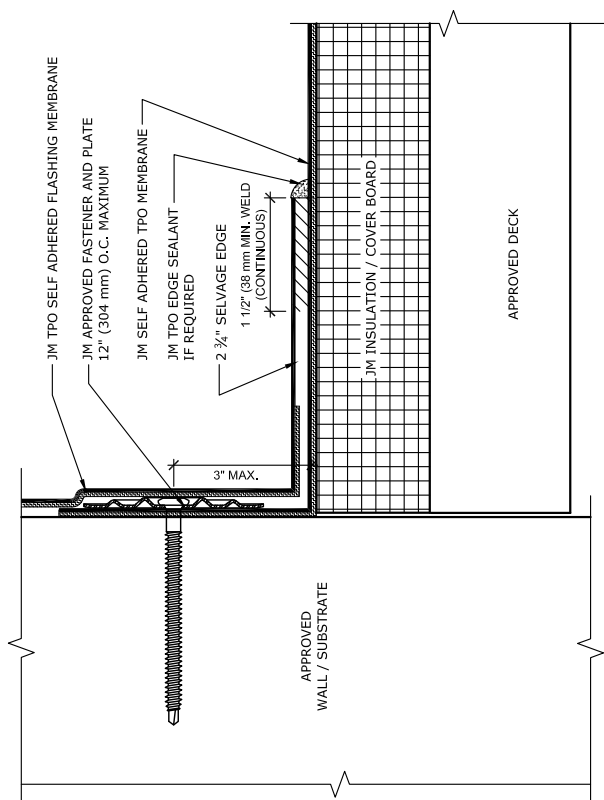

**NOTES:**

1. REFER TO JOHNS MANVILLE WEBSITE ([www.jm.com](http://www.jm.com)) FOR MOST UP-TO-DATE INFORMATION.
2. PLEASE SEE SINGLE PLY FLASHING SPECIFICATIONS FOR A FULL DESCRIPTION OF INSTALLATION INSTRUCTIONS AND REQUIREMENTS WHICH ARE CONSIDERED A PART OF THIS DETAIL.
3. ANY CARPENTRY OR METAL WORK SHOULD BE DESIGNED AND CONSTRUCTED IN ACCORDANCE WITH LOCAL CODE REQUIREMENTS AND/OR PROJECT SPECIFICATIONS. THESE COMPONENTS SHOULD BE REVIEWED AND APPROVED BY A LICENSED DESIGN PROFESSIONAL.
4. JM TPO EDGE SEALANT IS REQUIRED ON ALL CUT OR NON-ENCAPSULATED EDGES OF REINFORCED MEMBRANE. THIS INCLUDES FACTORY CUT MEMBRANE (SEE DETAIL T-MS-01).
5. THIS IS AN APPROVED BASE TIE-IN DETAIL FOR THE INSTALLATION OF TPO SELF ADHERED MEMBRANE. SEE MASTER DETAIL T-FW-M3I.

### Maximum Guarantee Term: 20 Years

Johns Manville is a manufacturer of commercial roofing products and offers this general conceptual information to you as a courtesy. This complimentary assistance is not to be used or relied upon by anyone as a substitute for professional engineering design and documentation required by building code, contract, or applicable law. By accepting these comments you agree they do not constitute any representations, endorsements of, or an assumption by Johns Manville of any liability for either the adequacy of design of this building or any other material not supplied by Johns Manville.

**Note:** For the most current information on general guidelines, please refer to the System Considerations tab under Commercial Roofing Products on the JM Roofing Web site. For specifications, flashing details and general installation information please refer to the Application Tools tab.

Refer to the Safe Use Instructions and product label prior to using this product.



## TPO Self-Adhered Membrane Flashing Base Tie-In High Int. Pressure

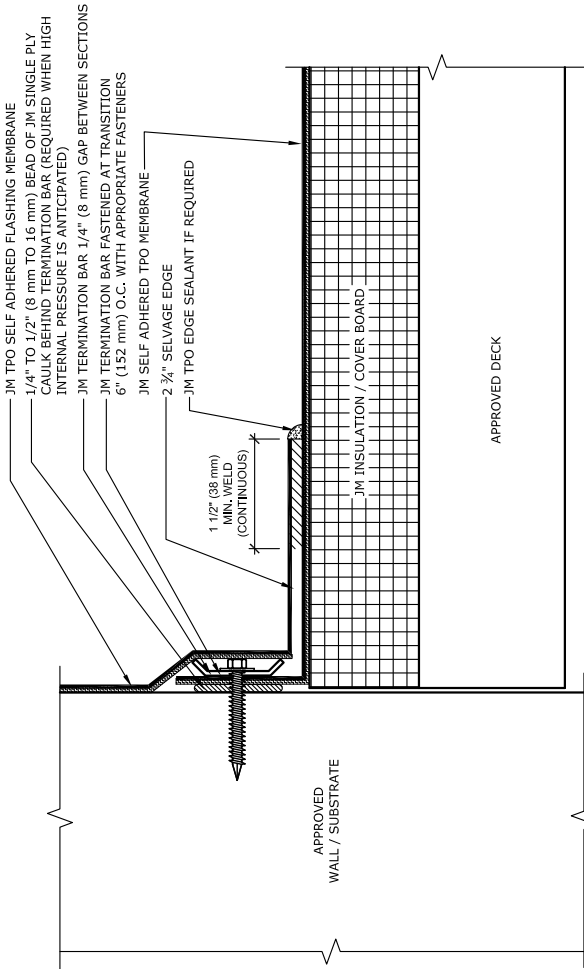

- NOTES:**
1. REFER TO JOHNS MANVILLE WEBSITE ([www.jm.com](http://www.jm.com)) FOR MOST UP-TO-DATE INFORMATION.
  2. PLEASE SEE SINGLE PLY FLASHING SPECIFICATIONS FOR A FULL DESCRIPTION OF INSTALLATION INSTRUCTIONS AND REQUIREMENTS WHICH ARE CONSIDERED A PART OF THIS DETAIL.
  3. ANY CARPENTRY OR METAL WORK SHOULD BE DESIGNED AND CONSTRUCTED IN ACCORDANCE WITH LOCAL CODE REQUIREMENTS AND/OR PROJECT SPECIFICATIONS. THESE COMPONENTS SHOULD BE REVIEWED AND APPROVED BY A LICENSED DESIGN PROFESSIONAL.
  4. JM TPO EDGE SEALANT IS REQUIRED ON ALL CUT OR NON-ENCAPSULATED EDGES OF REINFORCED MEMBRANE. THIS INCLUDES FACTORY CUT MEMBRANE (SEE DETAIL T-MS-01).
  5. THIS IS AN APPROVED BASE TIE-IN DETAIL FOR THE INSTALLATION OF JM TPO SELF ADHERED MEMBRANE. SEE MASTER DETAIL T-FW-M31.

### Maximum Guarantee Term: 20 Years

Johns Manville is a manufacturer of commercial roofing products and offers this general conceptual information to you as a courtesy. This complimentary assistance is not to be used or relied upon by anyone as a substitute for professional engineering design and documentation required by building code, contract, or applicable law. By accepting these comments you agree they do not constitute any representations, endorsements of, or an assumption by Johns Manville of any liability for either the adequacy of design of this building or any other material not supplied by Johns Manville.

**Note:** For the most current information on general guidelines, please refer to the System Considerations tab under Commercial Roofing Products on the JM Roofing Web site. For specifications, flashing details and general installation information please refer to the Application Tools tab.

Refer to the Safe Use Instructions and product label prior to using this product.



## TPO Self-Adhered Base Tie-In Fastener & Plate with TPO Cover Strip

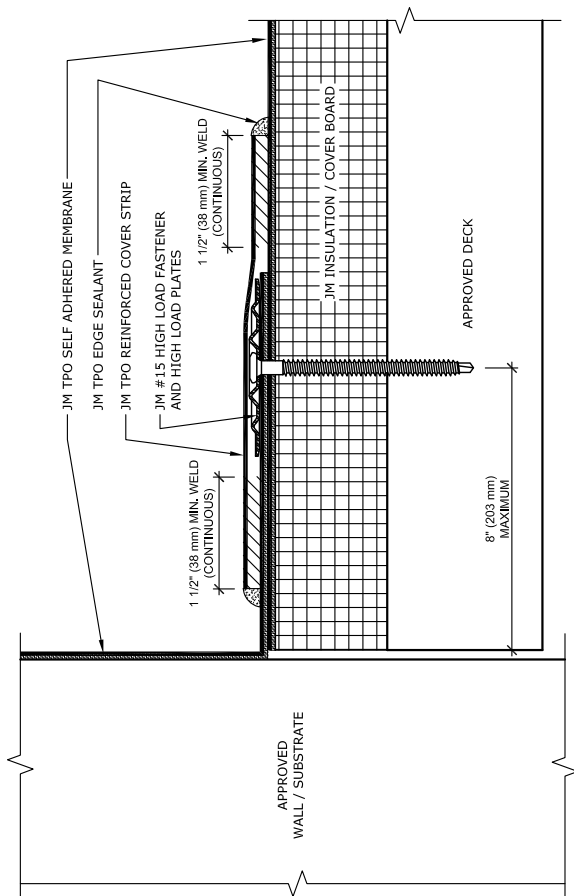

### NOTES:

1. REFER TO JOHNS MANVILLE WEBSITE ([www.jm.com](http://www.jm.com)) FOR MOST UP-TO-DATE INFORMATION.
2. PLEASE SEE SINGLE PLY FLASHING SPECIFICATIONS FOR A FULL DESCRIPTION OF INSTALLATION INSTRUCTIONS AND REQUIREMENTS WHICH ARE CONSIDERED A PART OF THIS DETAIL.
3. ANY CARPENTRY OR METAL WORK SHOULD BE DESIGNED AND CONSTRUCTED IN ACCORDANCE WITH LOCAL CODE REQUIREMENTS AND/OR PROJECT SPECIFICATIONS. THESE COMPONENTS SHOULD BE REVIEWED AND APPROVED BY A LICENSED DESIGN PROFESSIONAL.
4. JM TPO EDGE SEALANT IS REQUIRED ON ALL CUT OR NON-ENCAPSULATED EDGES OF REINFORCED MEMBRANE. THIS INCLUDES FACTORY CUT MEMBRANE (SEE DETAIL T-MS-01).
5. THIS IS AN APPROVED BASE TIE-IN DETAIL FOR THE INSTALLATION OF JM TPO SELF ADHERED MEMBRANE. SEE MASTER DETAIL T-FW-M31.

## Maximum Guarantee Term: 20 Years

Johns Manville is a manufacturer of commercial roofing products and offers this general conceptual information to you as a courtesy. This complimentary assistance is not to be used or relied upon by anyone as a substitute for professional engineering design and documentation required by building code, contract, or applicable law. By accepting these comments you agree they do not constitute any representations, endorsements of, or an assumption by Johns Manville of any liability for either the adequacy of design of this building or any other material not supplied by Johns Manville.

**Note:** For the most current information on general guidelines, please refer to the System Considerations tab under Commercial Roofing Products on the JM Roofing Web site. For specifications, flashing details and general installation information please refer to the Application Tools tab.

Refer to the Safe Use Instructions and product label prior to using this product.



## TPO Intermediate Membrane Attachment with Fastener & Plate

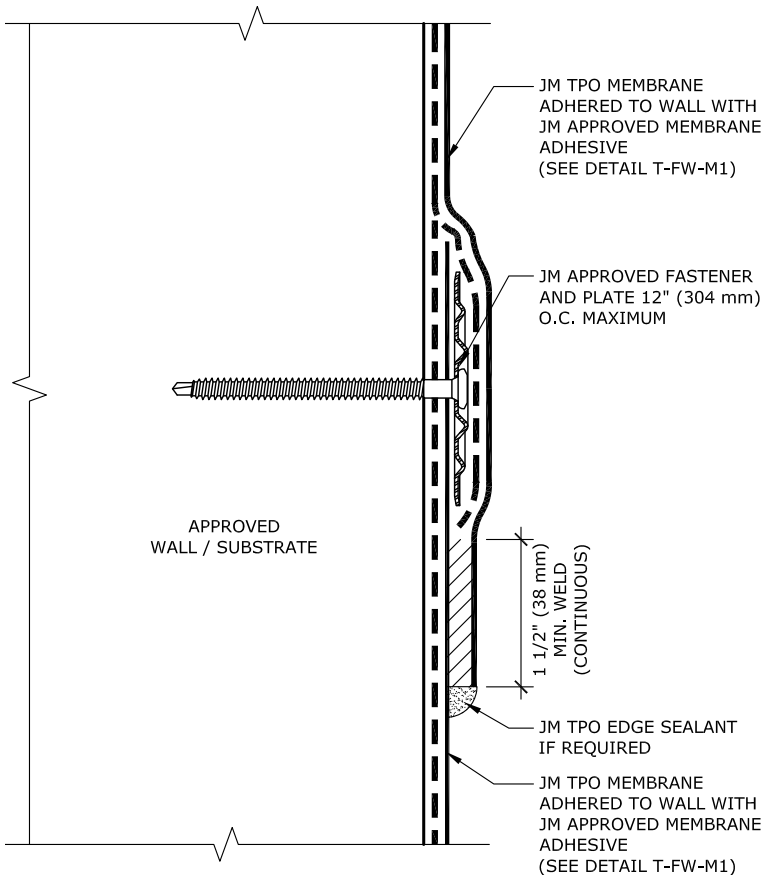

**NOTES:**

1. REFER TO JOHNS MANVILLE WEBSITE ([www.jm.com](http://www.jm.com)) FOR MOST UP-TO-DATE INFORMATION.
2. PLEASE SEE SINGLE PLY FLASHING SPECIFICATIONS FOR A FULL DESCRIPTION OF INSTALLATION INSTRUCTIONS AND REQUIREMENTS WHICH ARE CONSIDERED A PART OF THIS DETAIL.
3. ANY CARPENTRY OR METAL WORK SHOULD BE DESIGNED AND CONSTRUCTED IN ACCORDANCE WITH LOCAL CODE REQUIREMENTS AND/OR PROJECT SPECIFICATIONS. THESE COMPONENTS SHOULD BE REVIEWED AND APPROVED BY A LICENSED DESIGN PROFESSIONAL.
4. A SUFFICIENT BACKER FASTENING STRIP MUST BE INSTALLED BEHIND SUBSTRATES DIRECTLY TO STUDS FOR INSTALLATION OF TERMINATION BARS, AND FLASHINGS WHEN SUBSTRATES WILL NOT SUPPORT A PROPER, SECURE INSTALLATION.

### Maximum Guarantee Term: 30 Year

Johns Manville is a manufacturer of commercial roofing products and offers this general conceptual information to you as a courtesy. This complimentary assistance is not to be used or relied upon by anyone as a substitute for professional engineering design and documentation required by building code, contract, or applicable law. By accepting these comments you agree they do not constitute any representations, endorsements of, or an assumption by Johns Manville of any liability for either the adequacy of design of this building or any other material not supplied by Johns Manville.

**Note:** For the most current information on general guidelines, please refer to the System Considerations tab under Commercial Roofing Products on the JM Roofing Web site. For specifications, flashing details and general installation information please refer to the Application Tools tab.

Refer to the Safe Use Instructions and product label prior to using this product.



## TPO Cover Strip Wall Flashing Attachment with Fastener & Plate

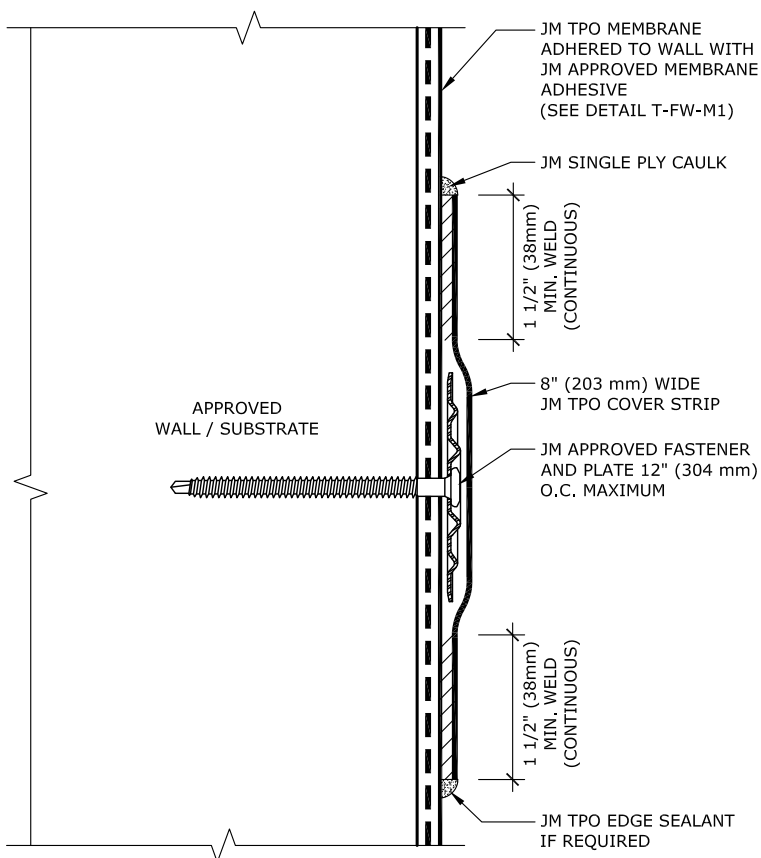

### NOTES:

1. REFER TO JOHNS MANVILLE WEBSITE ([www.jm.com](http://www.jm.com)) FOR MOST UP-TO-DATE INFORMATION.
2. PLEASE SEE SINGLE PLY FLASHING SPECIFICATIONS FOR A FULL DESCRIPTION OF INSTALLATION INSTRUCTIONS AND REQUIREMENTS WHICH ARE CONSIDERED A PART OF THIS DETAIL.
3. ANY CARPENTRY OR METAL WORK SHOULD BE DESIGNED AND CONSTRUCTED IN ACCORDANCE WITH LOCAL CODE REQUIREMENTS AND/OR PROJECT SPECIFICATIONS. THESE COMPONENTS SHOULD BE REVIEWED AND APPROVED BY A LICENSED DESIGN PROFESSIONAL.
4. ALL SEALANTS / CAULKING SHALL BE PERIODICALLY INSPECTED AND MAINTAINED BY THE BUILDING OWNER THROUGHOUT THE LIFE OF THE ROOF.
5. A SUFFICIENT BACKER FASTENING STRIP MUST BE INSTALLED BEHIND SUBSTRATES DIRECTLY TO STUDS FOR INSTALLATION OF TERMINATION BARS, AND FLASHINGS WHEN SUBSTRATES WILL NOT SUPPORT A PROPER, SECURE INSTALLATION.

### Maximum Guarantee Term: 30 Year

Johns Manville is a manufacturer of commercial roofing products and offers this general conceptual information to you as a courtesy. This complimentary assistance is not to be used or relied upon by anyone as a substitute for professional engineering design and documentation required by building code, contract, or applicable law. By accepting these comments you agree they do not constitute any representations, endorsements of, or an assumption by Johns Manville of any liability for either the adequacy of design of this building or any other material not supplied by Johns Manville.

**Note:** For the most current information on general guidelines, please refer to the System Considerations tab under Commercial Roofing Products on the JM Roofing Web site. For specifications, flashing details and general installation information please refer to the Application Tools tab.

Refer to the Safe Use Instructions and product label prior to using this product.



## TPO Intermediate Attachment with Term Bar

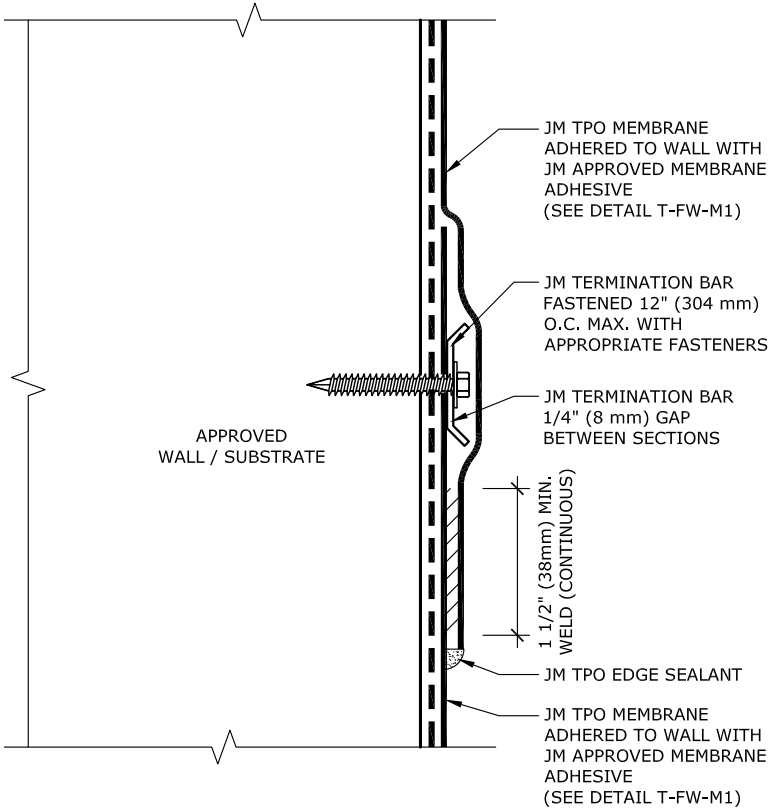

### NOTES:

1. REFER TO JOHNS MANVILLE WEBSITE ([www.jm.com](http://www.jm.com)) FOR MOST UP-TO-DATE INFORMATION.
2. PLEASE SEE SINGLE PLY FLASHING SPECIFICATIONS FOR A FULL DESCRIPTION OF INSTALLATION INSTRUCTIONS AND REQUIREMENTS WHICH ARE CONSIDERED A PART OF THIS DETAIL.
3. ANY CARPENTRY OR METAL WORK SHOULD BE DESIGNED AND CONSTRUCTED IN ACCORDANCE WITH LOCAL CODE REQUIREMENTS AND/OR PROJECT SPECIFICATIONS. THESE COMPONENTS SHOULD BE REVIEWED AND APPROVED BY A LICENSED DESIGN PROFESSIONAL.
4. A SUFFICIENT BACKER FASTENING STRIP MUST BE INSTALLED BEHIND SUBSTRATES DIRECTLY TO STUDS FOR INSTALLATION OF TERMINATION BARS, AND FLASHINGS WHEN SUBSTRATES WILL NOT SUPPORT A PROPER, SECURE INSTALLATION.

## Maximum Guarantee Term: 30 Year

Johns Manville is a manufacturer of commercial roofing products and offers this general conceptual information to you as a courtesy. This complimentary assistance is not to be used or relied upon by anyone as a substitute for professional engineering design and documentation required by building code, contract, or applicable law. By accepting these comments you agree they do not constitute any representations, endorsements of, or an assumption by Johns Manville of any liability for either the adequacy of design of this building or any other material not supplied by Johns Manville.

**Note:** For the most current information on general guidelines, please refer to the System Considerations tab under Commercial Roofing Products on the JM Roofing Web site. For specifications, flashing details and general installation information please refer to the Application Tools tab.

Refer to the Safe Use Instructions and product label prior to using this product.



### Term Bar Attachment with Welded TPO Cover Strip

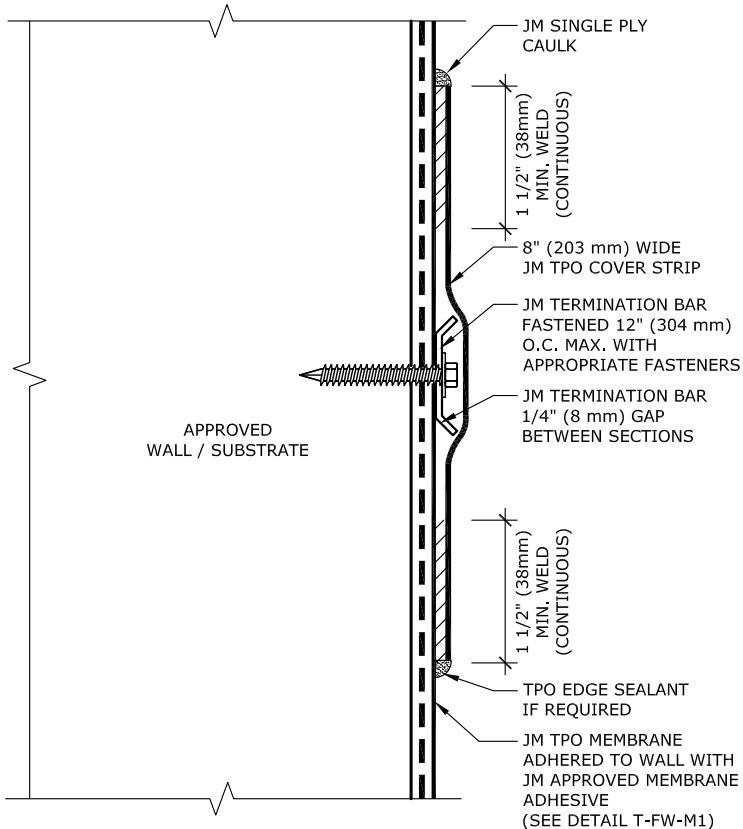

**NOTES:**

1. REFER TO JOHNS MANVILLE WEBSITE ([www.jm.com](http://www.jm.com)) FOR MOST UP-TO-DATE INFORMATION.
2. PLEASE SEE SINGLE PLY FLASHING SPECIFICATIONS FOR A FULL DESCRIPTION OF INSTALLATION INSTRUCTIONS AND REQUIREMENTS WHICH ARE CONSIDERED A PART OF THIS DETAIL.
3. ANY CARPENTRY OR METAL WORK SHOULD BE DESIGNED AND CONSTRUCTED IN ACCORDANCE WITH LOCAL CODE REQUIREMENTS AND/OR PROJECT SPECIFICATIONS. THESE COMPONENTS SHOULD BE REVIEWED AND APPROVED BY A LICENSED DESIGN PROFESSIONAL.
4. ALL SEALANTS / CAULKING SHALL BE PERIODICALLY INSPECTED AND MAINTAINED BY THE BUILDING OWNER THROUGHOUT THE LIFE OF THE ROOF.
5. A SUFFICIENT BACKER FASTENING STRIP MUST BE INSTALLED BEHIND SUBSTRATES DIRECTLY TO STUDS FOR INSTALLATION OF TERMINATION BARS, BATTEN STRIPS, AND FLASHINGS WHEN SUBSTRATES WILL NOT SUPPORT A PROPER, SECURE INSTALLATION.

### Maximum Guarantee Term: 30 Year

Johns Manville is a manufacturer of commercial roofing products and offers this general conceptual information to you as a courtesy. This complimentary assistance is not to be used or relied upon by anyone as a substitute for professional engineering design and documentation required by building code, contract, or applicable law. By accepting these comments you agree they do not constitute any representations, endorsements of, or an assumption by Johns Manville of any liability for either the adequacy of design of this building or any other material not supplied by Johns Manville.

**Note:** For the most current information on general guidelines, please refer to the System Considerations tab under Commercial Roofing Products on the JM Roofing Web site. For specifications, flashing details and general installation information please refer to the Application Tools tab.

Refer to the Safe Use Instructions and product label prior to using this product.





## Continuous Flashing Attachment - Termination Bar

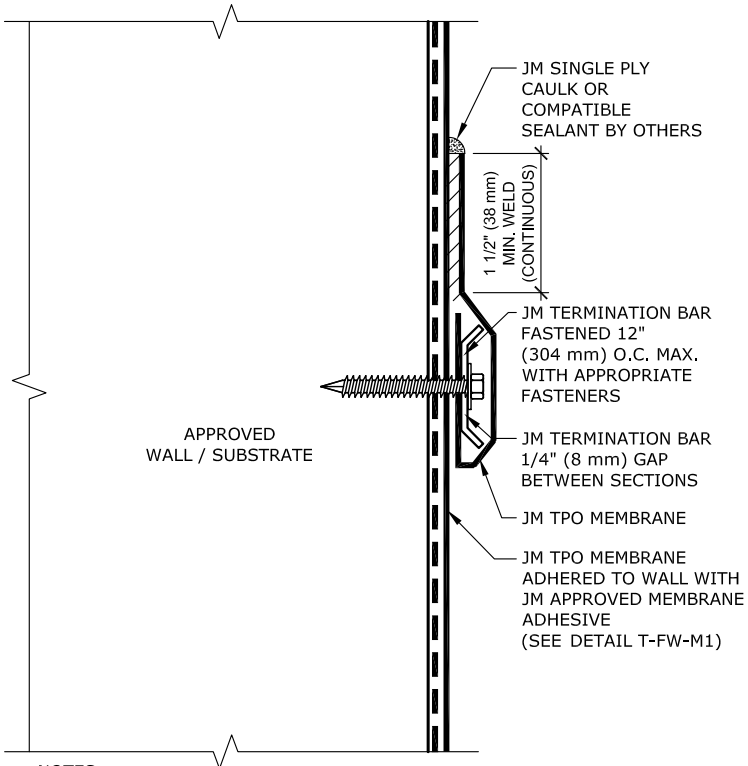

### NOTES:

1. REFER TO JOHNS MANVILLE WEBSITE ([www.jm.com](http://www.jm.com)) FOR MOST UP-TO-DATE INFORMATION.
2. PLEASE SEE SINGLE PLY FLASHING SPECIFICATIONS FOR A FULL DESCRIPTION OF INSTALLATION INSTRUCTIONS AND REQUIREMENTS WHICH ARE CONSIDERED A PART OF THIS DETAIL.
3. ANY CARPENTRY OR METAL WORK SHOULD BE DESIGNED AND CONSTRUCTED IN ACCORDANCE WITH LOCAL CODE REQUIREMENTS AND/OR PROJECT SPECIFICATIONS. THESE COMPONENTS SHOULD BE REVIEWED AND APPROVED BY A LICENSED DESIGN PROFESSIONAL.
4. ALL SEALANTS / CAULKING SHALL BE PERIODICALLY INSPECTED AND MAINTAINED BY THE BUILDING OWNER THROUGHOUT THE LIFE OF THE ROOF.
5. A SUFFICIENT BACKER FASTENING STRIP MUST BE INSTALLED BEHIND SUBSTRATES DIRECTLY TO STUDS FOR INSTALLATION OF TERMINATION BARS, AND FLASHINGS WHEN SUBSTRATES WILL NOT SUPPORT A PROPER, SECURE INSTALLATION.

### Maximum Guarantee Term: 30 Year

Johns Manville is a manufacturer of commercial roofing products and offers this general conceptual information to you as a courtesy. This complimentary assistance is not to be used or relied upon by anyone as a substitute for professional engineering design and documentation required by building code, contract, or applicable law. By accepting these comments you agree they do not constitute any representations, endorsements of, or an assumption by Johns Manville of any liability for either the adequacy of design of this building or any other material not supplied by Johns Manville.

**Note:** For the most current information on general guidelines, please refer to the System Considerations tab under Commercial Roofing Products on the JM Roofing Web site. For specifications, flashing details and general installation information please refer to the Application Tools tab.

Refer to the Safe Use Instructions and product label prior to using this product.



## Split Flashing Attachment - Termination Bar

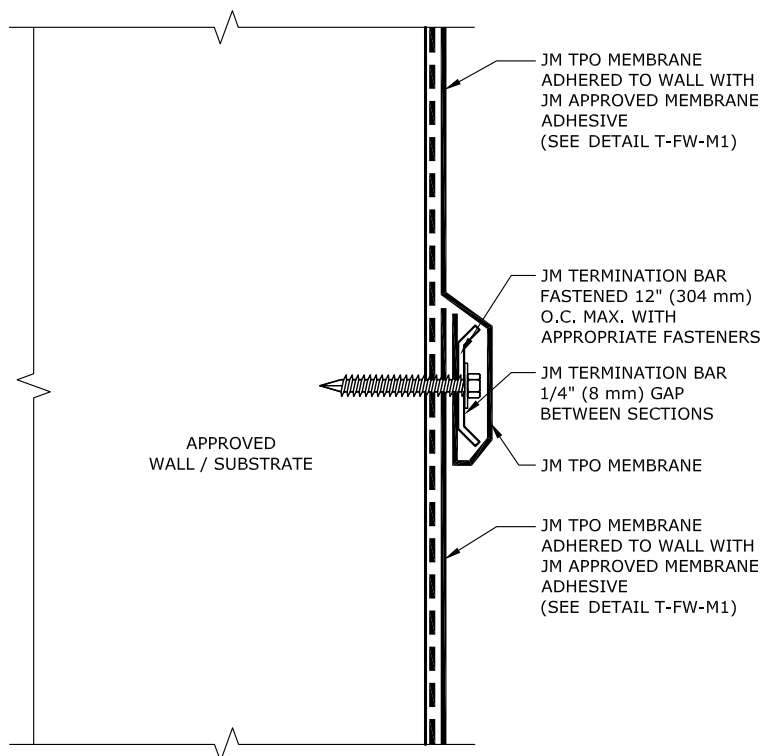

### NOTES:

1. REFER TO JOHNS MANVILLE WEBSITE ([www.jm.com](http://www.jm.com)) FOR MOST UP-TO-DATE INFORMATION.
2. PLEASE SEE SINGLE PLY FLASHING SPECIFICATIONS FOR A FULL DESCRIPTION OF INSTALLATION INSTRUCTIONS AND REQUIREMENTS WHICH ARE CONSIDERED A PART OF THIS DETAIL.
3. ANY CARPENTRY OR METAL WORK SHOULD BE DESIGNED AND CONSTRUCTED IN ACCORDANCE WITH LOCAL CODE REQUIREMENTS AND/OR PROJECT SPECIFICATIONS. THESE COMPONENTS SHOULD BE REVIEWED AND APPROVED BY A LICENSED DESIGN PROFESSIONAL.
4. A SUFFICIENT BACKER FASTENING STRIP MUST BE INSTALLED BEHIND SUBSTRATES DIRECTLY TO STUDS FOR INSTALLATION OF TERMINATION BARS, AND FLASHINGS WHEN SUBSTRATES WILL NOT SUPPORT A PROPER, SECURE INSTALLATION.

## Maximum Guarantee Term: 30 Year

Johns Manville is a manufacturer of commercial roofing products and offers this general conceptual information to you as a courtesy. This complimentary assistance is not to be used or relied upon by anyone as a substitute for professional engineering design and documentation required by building code, contract, or applicable law. By accepting these comments you agree they do not constitute any representations, endorsements of, or an assumption by Johns Manville of any liability for either the adequacy of design of this building or any other material not supplied by Johns Manville.

**Note:** For the most current information on general guidelines, please refer to the System Considerations tab under Commercial Roofing Products on the JM Roofing Web site. For specifications, flashing details and general installation information please refer to the Application Tools tab.

Refer to the Safe Use Instructions and product label prior to using this product.



## TPO Intermediate Termination with Counter Flashing & Cut-In Reglet

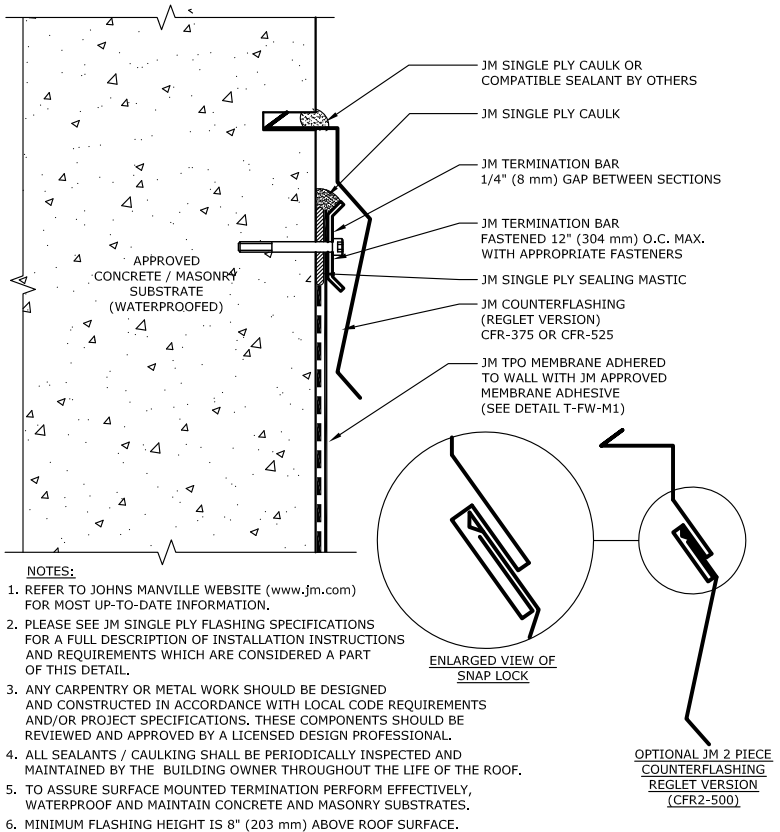

### Maximum Guarantee Term: 30 Year

Johns Manville is a manufacturer of commercial roofing products and offers this general conceptual information to you as a courtesy. This complimentary assistance is not to be used or relied upon by anyone as a substitute for professional engineering design and documentation required by building code, contract, or applicable law. By accepting these comments you agree they do not constitute any representations, endorsements of, or an assumption by Johns Manville of any liability for either the adequacy of design of this building or any other material not supplied by Johns Manville.

**Note:** For the most current information on general guidelines, please refer to the System Considerations tab under Commercial Roofing Products on the JM Roofing Web site. For specifications, flashing details and general installation information please refer to the Application Tools tab.

Refer to the Safe Use Instructions and product label prior to using this product.



## TPO Intermediate Termination with Surface Mounted Counter Flashing

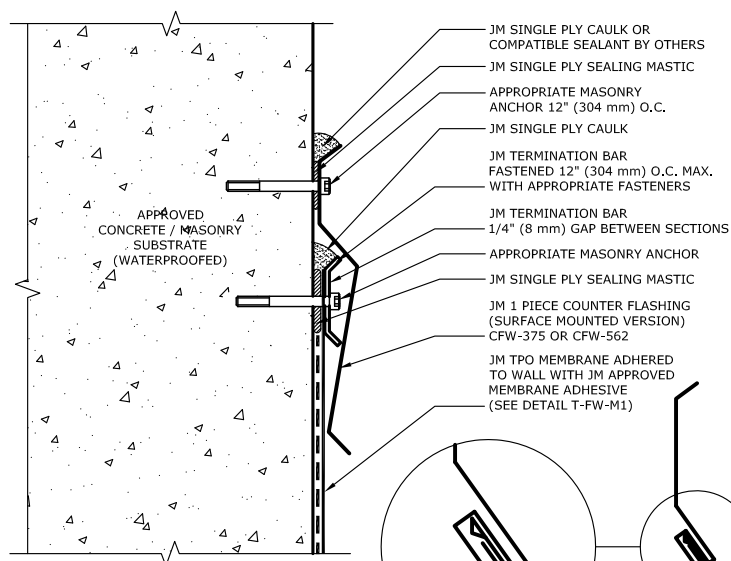

**NOTES:**

1. REFER TO JOHNS MANVILLE WEBSITE ([www.jm.com](http://www.jm.com)) FOR MOST UP-TO-DATE INFORMATION.
2. PLEASE SEE JM SINGLE PLY FLASHING SPECIFICATIONS FOR A FULL DESCRIPTION OF INSTALLATION INSTRUCTIONS AND REQUIREMENTS WHICH ARE CONSIDERED A PART OF THIS DETAIL.
3. ANY CARPENTRY OR METAL WORK SHOULD BE DESIGNED AND CONSTRUCTED IN ACCORDANCE WITH LOCAL CODE REQUIREMENTS AND/OR PROJECT SPECIFICATIONS. THESE COMPONENTS SHOULD BE REVIEWED AND APPROVED BY A LICENSED DESIGN PROFESSIONAL.
4. ALL SEALANTS / CAULKING SHALL BE PERIODICALLY INSPECTED AND MAINTAINED BY THE BUILDING OWNER THROUGHOUT THE LIFE OF THE ROOF.
5. TO ASSURE SURFACE MOUNTED TERMINATION PERFORM EFFECTIVELY, WATERPROOF AND MAINTAIN CONCRETE AND MASONRY SUBSTRATES.
6. MINIMUM FLASHING HEIGHT IS 8" (203 mm) ABOVE ROOF SURFACE.

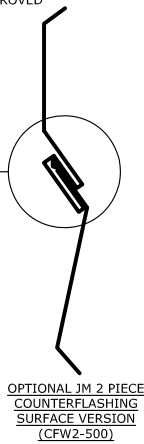
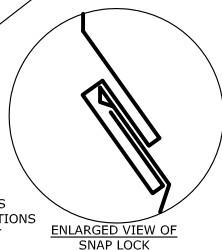

### Maximum Guarantee Term: 20 Year

Johns Manville is a manufacturer of commercial roofing products and offers this general conceptual information to you as a courtesy. This complimentary assistance is not to be used or relied upon by anyone as a substitute for professional engineering design and documentation required by building code, contract, or applicable law. By accepting these comments you agree they do not constitute any representations, endorsements of, or an assumption by Johns Manville of any liability for either the adequacy of design of this building or any other material not supplied by Johns Manville.

**Note:** For the most current information on general guidelines, please refer to the System Considerations tab under Commercial Roofing Products on the JM Roofing Web site. For specifications, flashing details and general installation information please refer to the Application Tools tab.

Refer to the Safe Use Instructions and product label prior to using this product.



## TPO Intermediate Termination with Thru Wall Counter Flashing

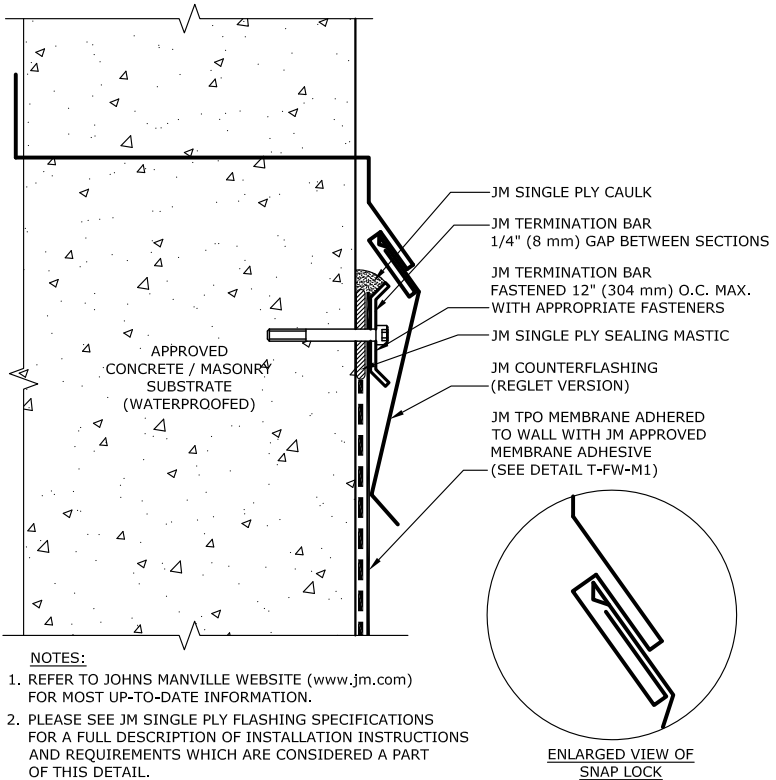

**NOTES:**

1. REFER TO JOHNS MANVILLE WEBSITE ([www.jm.com](http://www.jm.com)) FOR MOST UP-TO-DATE INFORMATION.
2. PLEASE SEE JM SINGLE PLY FLASHING SPECIFICATIONS FOR A FULL DESCRIPTION OF INSTALLATION INSTRUCTIONS AND REQUIREMENTS WHICH ARE CONSIDERED A PART OF THIS DETAIL.
3. ANY CARPENTRY OR METAL WORK SHOULD BE DESIGNED AND CONSTRUCTED IN ACCORDANCE WITH LOCAL CODE REQUIREMENTS AND/OR PROJECT SPECIFICATIONS. THESE COMPONENTS SHOULD BE REVIEWED AND APPROVED BY A LICENSED DESIGN PROFESSIONAL.
4. ALL SEALANTS / CAULKING SHALL BE PERIODICALLY INSPECTED AND MAINTAINED BY THE BUILDING OWNER THROUGHOUT THE LIFE OF THE ROOF.
5. TO ASSURE SURFACE MOUNTED TERMINATION PERFORM EFFECTIVELY, WATERPROOF AND MAINTAIN CONCRETE AND MASONRY SUBSTRATES.
6. MINIMUM FLASHING HEIGHT IS 8" (203 mm) ABOVE ROOF SURFACE.

### Maximum Guarantee Term: 20 Year

Johns Manville is a manufacturer of commercial roofing products and offers this general conceptual information to you as a courtesy. This complimentary assistance is not to be used or relied upon by anyone as a substitute for professional engineering design and documentation required by building code, contract, or applicable law. By accepting these comments you agree they do not constitute any representations, endorsements of, or an assumption by Johns Manville of any liability for either the adequacy of design of this building or any other material not supplied by Johns Manville.

**Note:** For the most current information on general guidelines, please refer to the System Considerations tab under Commercial Roofing Products on the JM Roofing Web site. For specifications, flashing details and general installation information please refer to the Application Tools tab.

Refer to the Safe Use Instructions and product label prior to using this product.



## TPO Intermediate Termination with Termination Bar

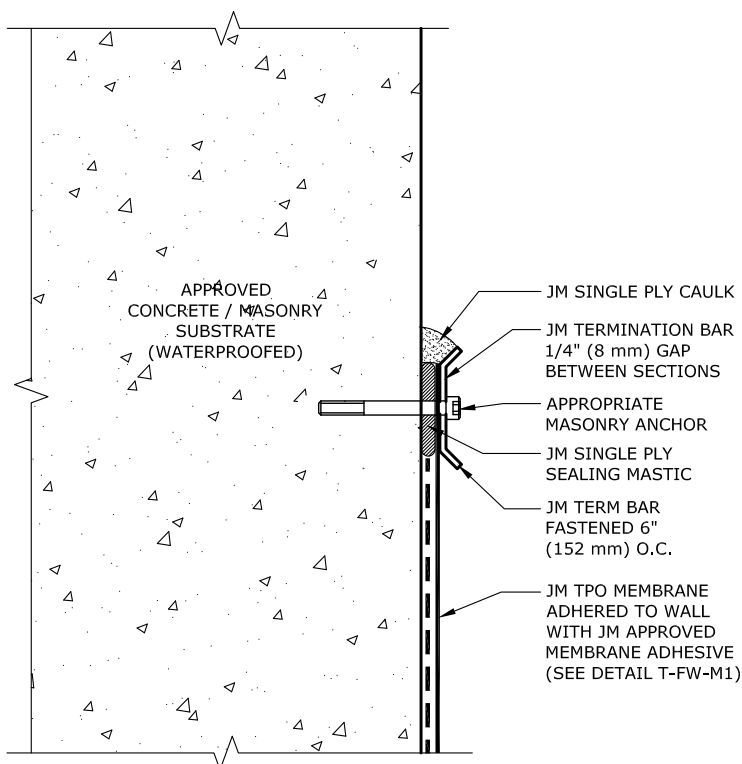

### NOTES:

1. REFER TO JOHNS MANVILLE WEBSITE ([www.jm.com](http://www.jm.com)) FOR MOST UP-TO-DATE INFORMATION.
2. PLEASE SEE JM SINGLE PLY FLASHING SPECIFICATIONS FOR A FULL DESCRIPTION OF INSTALLATION INSTRUCTIONS AND REQUIREMENTS WHICH ARE CONSIDERED A PART OF THIS DETAIL.
3. ANY CARPENTRY OR METAL WORK SHOULD BE DESIGNED AND CONSTRUCTED IN ACCORDANCE WITH LOCAL CODE REQUIREMENTS AND/OR PROJECT SPECIFICATIONS. THESE COMPONENTS SHOULD BE REVIEWED AND APPROVED BY A LICENSED DESIGN PROFESSIONAL.
4. ALL SEALANTS / CAULKING SHALL BE PERIODICALLY INSPECTED AND MAINTAINED BY THE BUILDING OWNER THROUGHOUT THE LIFE OF THE ROOF.
5. TO ASSURE SURFACE MOUNTED TERMINATIONS PERFORM EFFECTIVELY, WATERPROOF AND MAINTAIN CONCRETE AND MASONRY SUBSTRATES.
6. MINIMUM FLASHING HEIGHT IS 8" (203 mm) ABOVE ROOF SURFACE.

## Maximum Guarantee Term: 20 Year

Johns Manville is a manufacturer of commercial roofing products and offers this general conceptual information to you as a courtesy. This complimentary assistance is not to be used or relied upon by anyone as a substitute for professional engineering design and documentation required by building code, contract, or applicable law. By accepting these comments you agree they do not constitute any representations, endorsements of, or an assumption by Johns Manville of any liability for either the adequacy of design of this building or any other material not supplied by Johns Manville.

**Note:** For the most current information on general guidelines, please refer to the System Considerations tab under Commercial Roofing Products on the JM Roofing Web site. For specifications, flashing details and general installation information please refer to the Application Tools tab.

Refer to the Safe Use Instructions and product label prior to using this product.



## TPO Intermediate Termination Below Wall Cladding

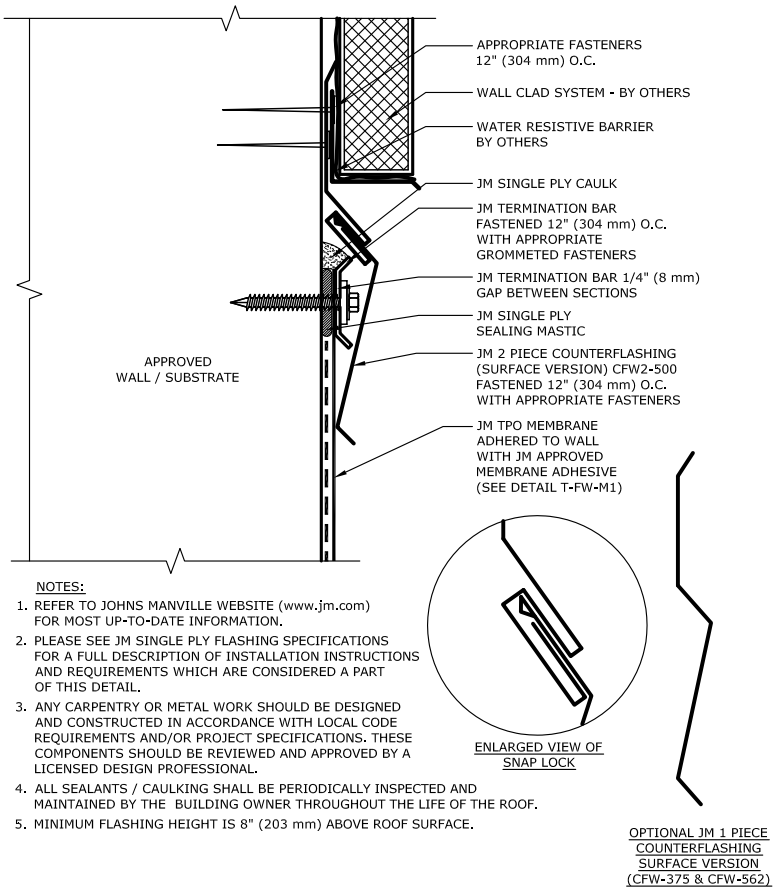

### Maximum Guarantee Term: 30 Year

Johns Manville is a manufacturer of commercial roofing products and offers this general conceptual information to you as a courtesy. This complimentary assistance is not to be used or relied upon by anyone as a substitute for professional engineering design and documentation required by building code, contract, or applicable law. By accepting these comments you agree they do not constitute any representations, endorsements of, or an assumption by Johns Manville of any liability for either the adequacy of design of this building or any other material not supplied by Johns Manville.

**Note:** For the most current information on general guidelines, please refer to the System Considerations tab under Commercial Roofing Products on the JM Roofing Web site. For specifications, flashing details and general installation information please refer to the Application Tools tab.

Refer to the Safe Use Instructions and product label prior to using this product.



## TPO Intermediate Membrane Termination with Termination Bar

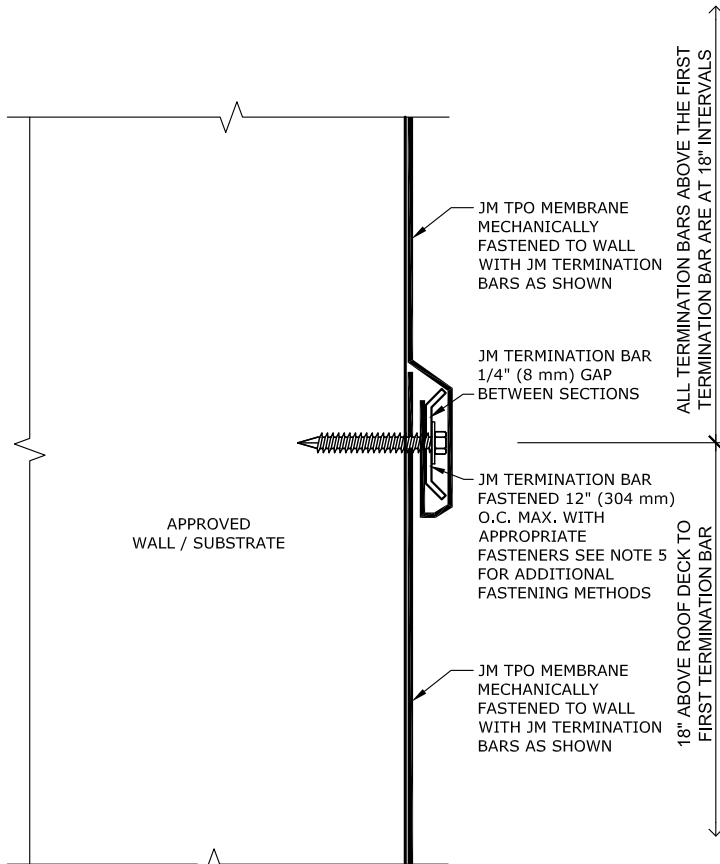

**NOTES:**

1. REFER TO JOHNS MANVILLE WEBSITE ([www.jm.com](http://www.jm.com)) FOR MOST UP-TO-DATE INFORMATION.
2. PLEASE SEE SINGLE PLY FLASHING SPECIFICATIONS FOR A FULL DESCRIPTION OF INSTALLATION INSTRUCTIONS AND REQUIREMENTS WHICH ARE CONSIDERED A PART OF THIS DETAIL.
3. ANY CARPENTRY OR METAL WORK SHOULD BE DESIGNED AND CONSTRUCTED IN ACCORDANCE WITH LOCAL CODE REQUIREMENTS AND/OR PROJECT SPECIFICATIONS. THESE COMPONENTS SHOULD BE REVIEWED AND APPROVED BY A LICENSED DESIGN PROFESSIONAL.
4. A SUFFICIENT BACKER FASTENING STRIP MUST BE INSTALLED BEHIND SUBSTRATES DIRECTLY TO STUDS FOR INSTALLATION OF TERMINATION BARS, BATTEN STRIPS, AND FLASHINGS WHEN SUBSTRATES WILL NOT SUPPORT A PROPER, SECURE INSTALLATION. SEE DETAIL T-FW-M21 FOR HIGH WALL FASTENING METHODS.
5. SEE DETAILS T-FW-I1 THROUGH T-FW-I5 FOR ALL APPROVED JM INTERMEDIATE FASTENING METHODS.

### Maximum Guarantee Term: 30 Year

Johns Manville is a manufacturer of commercial roofing products and offers this general conceptual information to you as a courtesy. This complimentary assistance is not to be used or relied upon by anyone as a substitute for professional engineering design and documentation required by building code, contract, or applicable law. By accepting these comments you agree they do not constitute any representations, endorsements of, or an assumption by Johns Manville of any liability for either the adequacy of design of this building or any other material not supplied by Johns Manville.

**Note:** For the most current information on general guidelines, please refer to the System Considerations tab under Commercial Roofing Products on the JM Roofing Web site. For specifications, flashing details and general installation information please refer to the Application Tools tab.

Refer to the Safe Use Instructions and product label prior to using this product.





## TPO Intermediate Termination Loose Hung Flashing

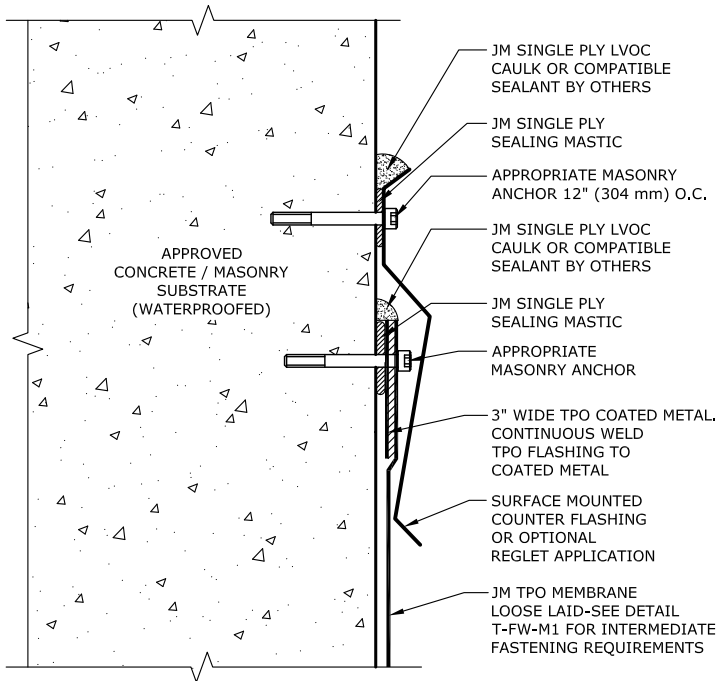

### NOTES:

1. REFER TO JOHNS MANVILLE WEBSITE ([www.jm.com](http://www.jm.com)) FOR MOST UP-TO-DATE INFORMATION.
2. PLEASE SEE JM SINGLE PLY FLASHING SPECIFICATIONS AND FOR A FULL DESCRIPTION OF INSTALLATION INSTRUCTIONS AND REQUIREMENTS WHICH ARE CONSIDERED A PART OF THIS DETAIL.
3. ANY CARPENTRY OR METAL WORK SHOULD BE DESIGNED AND CONSTRUCTED IN ACCORDANCE WITH LOCAL CODE REQUIREMENTS AND/OR PROJECT SPECIFICATIONS. THESE COMPONENTS SHOULD BE REVIEWED AND APPROVED BY A LICENSED DESIGN PROFESSIONAL.
4. ALL SEALANTS / CAULKING SHALL BE PERIODICALLY INSPECTED AND MAINTAINED BY THE BUILDING OWNER THROUGHOUT THE LIFE OF THE ROOF.
5. TO ASSURE SURFACE MOUNTED TERMINATIONS PERFORM EFFECTIVELY, WATERPROOF AND MAINTAIN CONCRETE AND MASONRY SUBSTRATES.
6. MINIMUM FLASHING HEIGHT IS 8" (203 mm) ABOVE ROOF SURFACE. INTERMEDIATE FLASHING FASTENING HEIGHT FOR NON-ADHERED MEMBRANE IS 18" (457 mm) MAXIMUM AND AT 18" (457 mm) INTERVALS.

### Maximum Guarantee Term: 20 Years

Johns Manville is a manufacturer of commercial roofing products and offers this general conceptual information to you as a courtesy. This complimentary assistance is not to be used or relied upon by anyone as a substitute for professional engineering design and documentation required by building code, contract, or applicable law. By accepting these comments you agree they do not constitute any representations, endorsements of, or an assumption by Johns Manville of any liability for either the adequacy of design of this building or any other material not supplied by Johns Manville.

**Note:** For the most current information on general guidelines, please refer to the System Considerations tab under Commercial Roofing Products on the JM Roofing Web site. For specifications, flashing details and general installation information please refer to the Application Tools tab.

Refer to the Safe Use Instructions and product label prior to using this product.



## Fabricated Metal Coping Over Adhered TPO

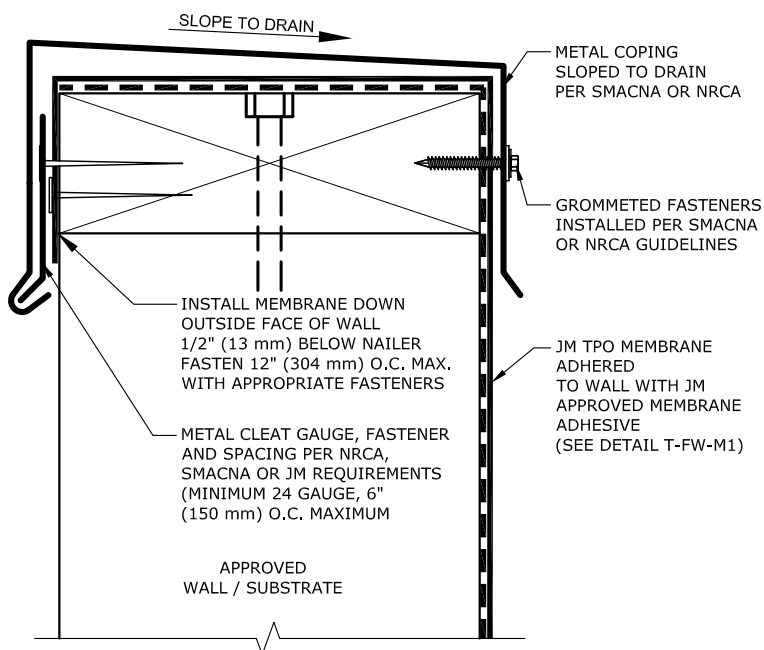

**NOTES:**

1. REFER TO JOHNS MANVILLE WEBSITE ([www.jm.com](http://www.jm.com)) FOR MOST UP-TO-DATE INFORMATION.
2. PLEASE SEE SINGLE PLY FLASHING SPECIFICATIONS FOR A FULL DESCRIPTION OF INSTALLATION INSTRUCTIONS AND REQUIREMENTS WHICH ARE CONSIDERED A PART OF THIS DETAIL.
3. ANY CARPENTRY OR METAL WORK SHOULD BE DESIGNED AND CONSTRUCTED IN ACCORDANCE WITH LOCAL CODE REQUIREMENTS AND/OR PROJECT SPECIFICATIONS. THESE COMPONENTS SHOULD BE REVIEWED AND APPROVED BY A LICENSED DESIGN PROFESSIONAL.

### Maximum Guarantee Term: 20 Year

Johns Manville is a manufacturer of commercial roofing products and offers this general conceptual information to you as a courtesy. This complimentary assistance is not to be used or relied upon by anyone as a substitute for professional engineering design and documentation required by building code, contract, or applicable law. By accepting these comments you agree they do not constitute any representations, endorsements of, or an assumption by Johns Manville of any liability for either the adequacy of design of this building or any other material not supplied by Johns Manville.

**Note:** For the most current information on general guidelines, please refer to the System Considerations tab under Commercial Roofing Products on the JM Roofing Web site. For specifications, flashing details and general installation information please refer to the Application Tools tab.

Refer to the Safe Use Instructions and product label prior to using this product.



## Presto Lock Coping System Over TPO

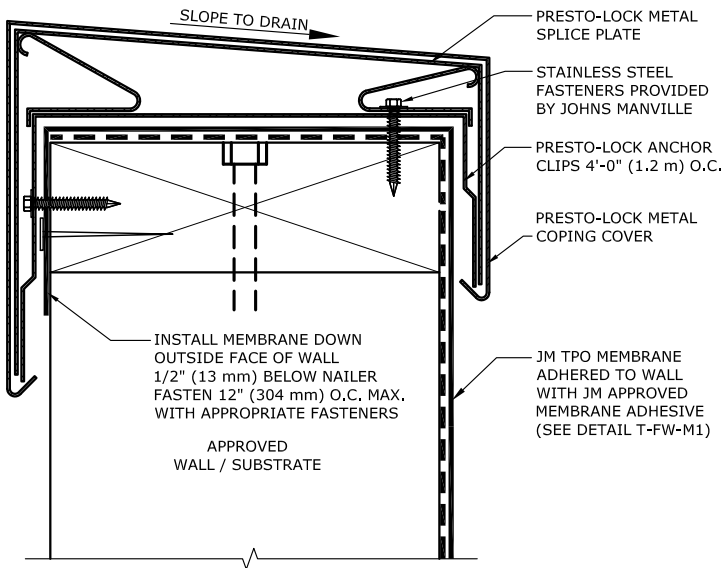

### NOTES:

1. REFER TO JOHNS MANVILLE WEBSITE ([www.jm.com](http://www.jm.com)) FOR MOST UP-TO-DATE INFORMATION.
2. PLEASE SEE SINGLE PLY FLASHING SPECIFICATIONS FOR A FULL DESCRIPTION OF INSTALLATION INSTRUCTIONS AND REQUIREMENTS WHICH ARE CONSIDERED A PART OF THIS DETAIL.
3. ANY CARPENTRY OR METAL WORK SHOULD BE DESIGNED AND CONSTRUCTED IN ACCORDANCE WITH LOCAL CODE REQUIREMENTS AND/OR PROJECT SPECIFICATIONS. THESE COMPONENTS SHOULD BE REVIEWED AND APPROVED BY A LICENSED DESIGN PROFESSIONAL.
4. REFER TO JM PRESTO LOCK COPING INSTALLATION INSTRUCTIONS FOR PROPER FASTENING REQUIREMENTS.

## Maximum Guarantee Term: 20 Year

Johns Manville is a manufacturer of commercial roofing products and offers this general conceptual information to you as a courtesy. This complimentary assistance is not to be used or relied upon by anyone as a substitute for professional engineering design and documentation required by building code, contract, or applicable law. By accepting these comments you agree they do not constitute any representations, endorsements of, or an assumption by Johns Manville of any liability for either the adequacy of design of this building or any other material not supplied by Johns Manville.

**Note:** For the most current information on general guidelines, please refer to the System Considerations tab under Commercial Roofing Products on the JM Roofing Web site. For specifications, flashing details and general installation information please refer to the Application Tools tab.

Refer to the Safe Use Instructions and product label prior to using this product.



## Presto-Tite Fascia System on Sloped Parapet

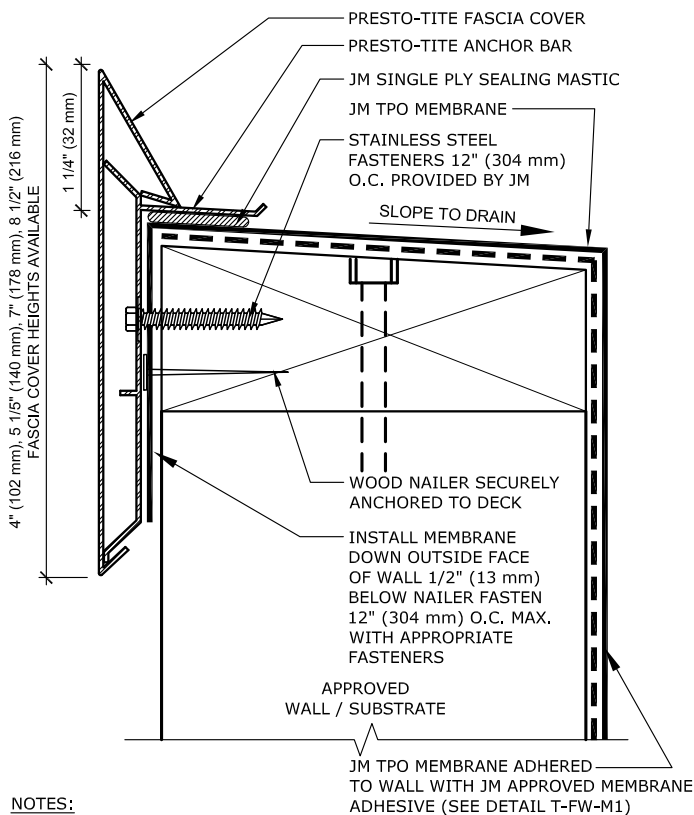

### NOTES:

1. REFER TO JOHNS MANVILLE WEBSITE ([www.jm.com](http://www.jm.com)) FOR MOST UP-TO-DATE INFORMATION.
2. INSTRUCTIONS AND REQUIREMENTS WHICH ARE CONSIDERED A PART OF THIS DETAIL.
3. ANY CARPENTRY OR METAL WORK SHOULD BE DESIGNED AND CONSTRUCTED IN ACCORDANCE WITH LOCAL CODE REQUIREMENTS AND/OR PROJECT SPECIFICATIONS. THESE COMPONENTS SHOULD BE REVIEWED AND APPROVED BY A LICENSED DESIGN PROFESSIONAL.
4. REFER TO JM PRESTO TITE FASCIA INSTALLATION INSTRUCTIONS FOR PROPER FASTENING REQUIREMENTS.
5. THE PRESTO-TITE SYSTEM SHOWN IS FOR SINGLE PLY ROOF SYSTEMS ONLY.

## Maximum Guarantee Term: 20 Year

Johns Manville is a manufacturer of commercial roofing products and offers this general conceptual information to you as a courtesy. This complimentary assistance is not to be used or relied upon by anyone as a substitute for professional engineering design and documentation required by building code, contract, or applicable law. By accepting these comments you agree they do not constitute any representations, endorsements of, or an assumption by Johns Manville of any liability for either the adequacy of design of this building or any other material not supplied by Johns Manville.

**Note:** For the most current information on general guidelines, please refer to the System Considerations tab under Commercial Roofing Products on the JM Roofing Web site. For specifications, flashing details and general installation information please refer to the Application Tools tab.

Refer to the Safe Use Instructions and product label prior to using this product.



## Perma-Tite Continuous Cleat Coping System Over TPO

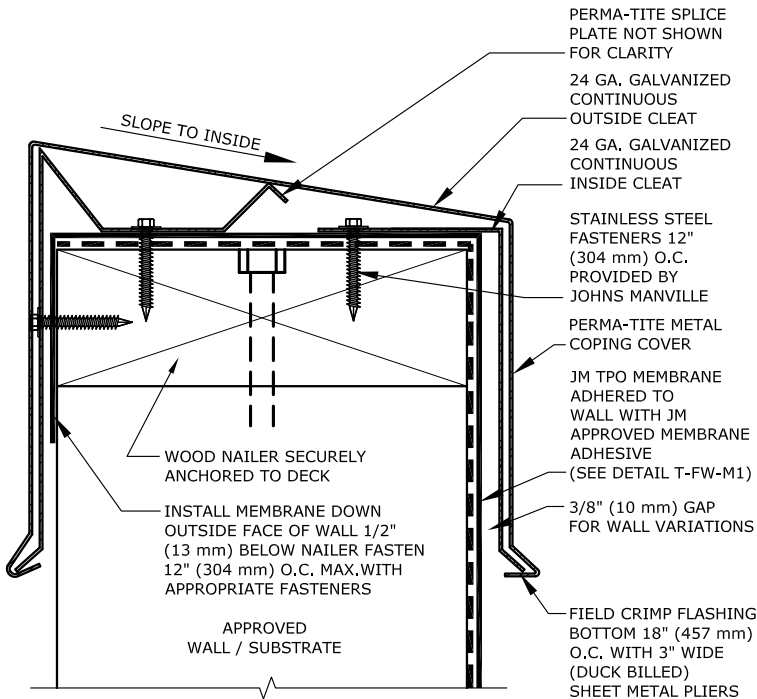

### NOTES:

1. REFER TO JOHNS MANVILLE WEBSITE ([www.jm.com](http://www.jm.com)) FOR MOST UP-TO-DATE INFORMATION.
2. PLEASE SEE SINGLE PLY FLASHING SPECIFICATIONS FOR A FULL DESCRIPTION OF INSTALLATION INSTRUCTIONS AND REQUIREMENTS WHICH ARE CONSIDERED A PART OF THIS DETAIL.
3. ANY CARPENTRY OR METAL WORK SHOULD BE DESIGNED AND CONSTRUCTED IN ACCORDANCE WITH LOCAL CODE REQUIREMENTS AND/OR PROJECT SPECIFICATIONS. THESE COMPONENTS SHOULD BE REVIEWED AND APPROVED BY A LICENSED DESIGN PROFESSIONAL.
4. REFER TO JM PERMA-TITE COPING INSTALLATION INSTRUCTIONS FOR PROPER FASTENING REQUIREMENTS.

## Maximum Guarantee Term: 20 Year

Johns Manville is a manufacturer of commercial roofing products and offers this general conceptual information to you as a courtesy. This complimentary assistance is not to be used or relied upon by anyone as a substitute for professional engineering design and documentation required by building code, contract, or applicable law. By accepting these comments you agree they do not constitute any representations, endorsements of, or an assumption by Johns Manville of any liability for either the adequacy of design of this building or any other material not supplied by Johns Manville.

**Note:** For the most current information on general guidelines, please refer to the System Considerations tab under Commercial Roofing Products on the JM Roofing Web site. For specifications, flashing details and general installation information please refer to the Application Tools tab.

Refer to the Safe Use Instructions and product label prior to using this product.



## Cut Edge Sealant

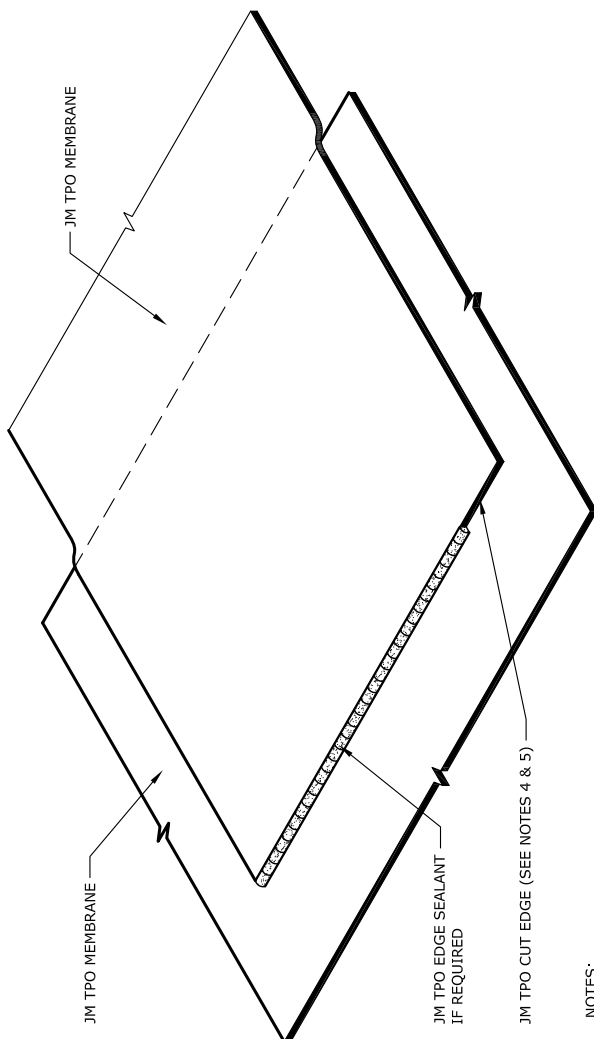

**NOTES:**

1. REFER TO JOHNS MANVILLE WEBSITE ([www.jm.com](http://www.jm.com)) FOR MOST UP-TO-DATE INFORMATION.
2. PLEASE SEE SINGLE PLY FLASHING SPECIFICATIONS FOR A FULL DESCRIPTION OF INSTALLATION INSTRUCTIONS AND REQUIREMENTS WHICH ARE CONSIDERED A PART OF THIS DETAIL.
3. ANY CARPENTRY OR METAL WORK SHOULD BE DESIGNED AND CONSTRUCTED IN ACCORDANCE WITH LOCAL CODE REQUIREMENTS AND/OR PROJECT SPECIFICATIONS. THESE COMPONENTS SHOULD BE REVIEWED AND APPROVED BY A LICENSED DESIGN PROFESSIONAL.
4. JM TPO EDGE SEALANT IS A ONE-PART POLYMERIC MATERIAL USED TO SEAL CUT EDGES OF JM TPO MEMBRANES WHERE THE POLYESTER REINFORCEMENT IS EXPOSED AFTER WELDING. A 1/8" (3.18 MM) BEAD IS APPLIED FROM A PLASTIC SQUEEZE BOTTLE TO THE CUT EDGE OF THE TPO MEMBRANE.
5. JM TPO EDGE SEALANT IS REQUIRED ON ALL CUT OR NON ENCAPSULATED EDGES OF REINFORCED MEMBRANE. THIS INCLUDES FACTORY CUT MEMBRANE.

### Maximum Guarantee Term: 30 Year

Johns Manville is a manufacturer of commercial roofing products and offers this general conceptual information to you as a courtesy. This complimentary assistance is not to be used or relied upon by anyone as a substitute for professional engineering design and documentation required by building code, contract, or applicable law. By accepting these comments you agree they do not constitute any representations, endorsements of, or an assumption by Johns Manville of any liability for either the adequacy of design of this building or any other material not supplied by Johns Manville.

**Note:** For the most current information on general guidelines, please refer to the System Considerations tab under Commercial Roofing Products on the JM Roofing Web site. For specifications, flashing details and general installation information please refer to the Application Tools tab.

Refer to the Safe Use Instructions and product label prior to using this product.



## In-Lap Fastening Method - Steel Deck

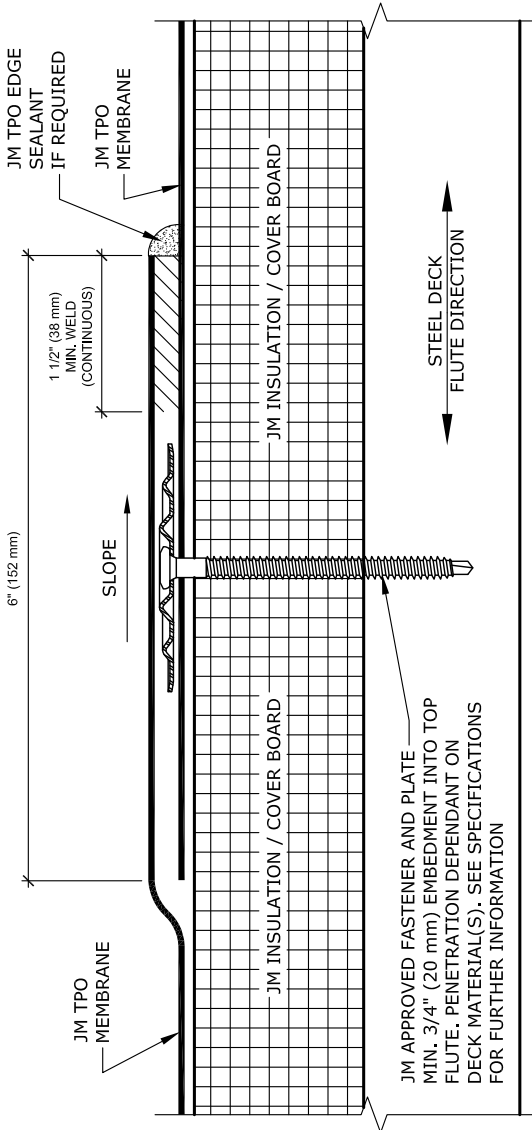

### NOTES:

1. REFER TO JOHNS MANVILLE WEBSITE ([www.jm.com](http://www.jm.com)) FOR MOST UP-TO-DATE INFORMATION.
2. PLEASE SEE SINGLE PLY FLASHING SPECIFICATIONS FOR A FULL DESCRIPTION OF INSTALLATION INSTRUCTIONS AND REQUIREMENTS WHICH ARE CONSIDERED A PART OF THIS DETAIL.
3. ANY CARPENTRY OR METAL WORK SHOULD BE DESIGNED AND CONSTRUCTED IN ACCORDANCE WITH LOCAL CODE REQUIREMENTS AND/OR PROJECT SPECIFICATIONS. THESE COMPONENTS SHOULD BE REVIEWED AND APPROVED BY A LICENSED DESIGN PROFESSIONAL.
4. JM TPO EDGE SEALANT IS REQUIRED ON ALL CUT OR NON-ENCAPSULATED EDGES OF REINFORCED MEMBRANE. THIS INCLUDES FACTORY CUT MEMBRANE (SEE DETAIL T-MS-01).

## Maximum Guarantee Term: 30 Year

Johns Manville is a manufacturer of commercial roofing products and offers this general conceptual information to you as a courtesy. This complimentary assistance is not to be used or relied upon by anyone as a substitute for professional engineering design and documentation required by building code, contract, or applicable law. By accepting these comments you agree they do not constitute any representations, endorsements of, or an assumption by Johns Manville of any liability for either the adequacy of design of this building or any other material not supplied by Johns Manville.

**Note:** For the most current information on general guidelines, please refer to the System Considerations tab under Commercial Roofing Products on the JM Roofing Web site. For specifications, flashing details and general installation information please refer to the Application Tools tab.

Refer to the Safe Use Instructions and product label prior to using this product.



## In-Lap Fastening Method - Plywood Deck

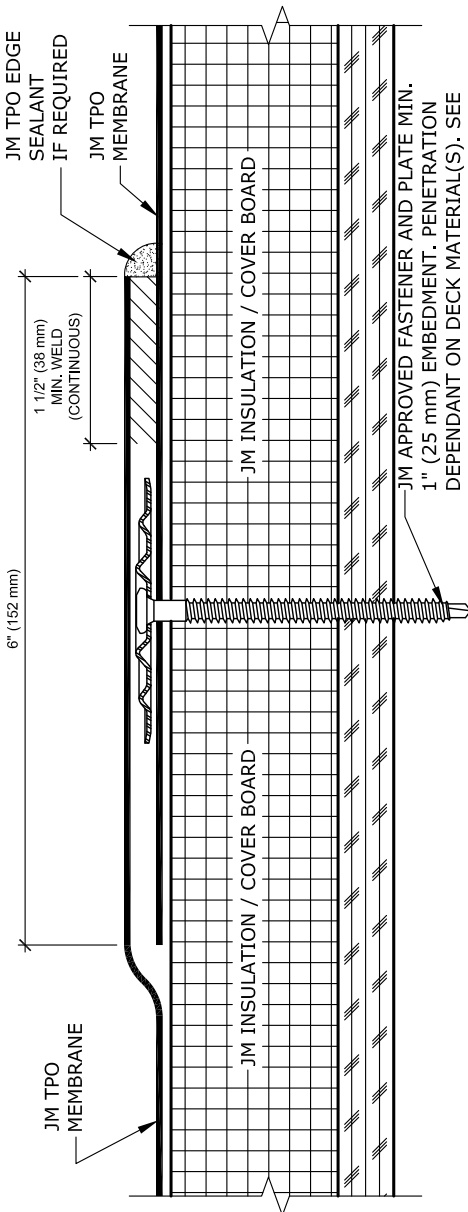

**NOTES:**

1. REFER TO JOHNS MANVILLE WEBSITE ([www.jm.com](http://www.jm.com)) FOR MOST UP-TO-DATE INFORMATION.
2. PLEASE SEE SINGLE PLY FLASHING SPECIFICATIONS FOR A FULL DESCRIPTION OF INSTALLATION INSTRUCTIONS AND REQUIREMENTS WHICH ARE CONSIDERED A PART OF THIS DETAIL.
3. ANY CARPENTRY OR METAL WORK SHOULD BE DESIGNED AND CONSTRUCTED IN ACCORDANCE WITH LOCAL CODE REQUIREMENTS AND/OR PROJECT SPECIFICATIONS. THESE COMPONENTS SHOULD BE REVIEWED AND APPROVED BY A LICENSED DESIGN PROFESSIONAL.
4. JM TPO EDGE SEALANT IS REQUIRED ON ALL CUT OR NON-ENCAPSULATED EDGES OF REINFORCED MEMBRANE. THIS INCLUDES FACTORY CUT MEMBRANE (SEE DETAIL T-MS-01).

### Maximum Guarantee Term: 30 Year

Johns Manville is a manufacturer of commercial roofing products and offers this general conceptual information to you as a courtesy. This complimentary assistance is not to be used or relied upon by anyone as a substitute for professional engineering design and documentation required by building code, contract, or applicable law. By accepting these comments you agree they do not constitute any representations, endorsements of, or an assumption by Johns Manville of any liability for either the adequacy of design of this building or any other material not supplied by Johns Manville.

**Note:** For the most current information on general guidelines, please refer to the System Considerations tab under Commercial Roofing Products on the JM Roofing Web site. For specifications, flashing details and general installation information please refer to the Application Tools tab.

Refer to the Safe Use Instructions and product label prior to using this product.





## In-Lap Fastening Method - Concrete Deck

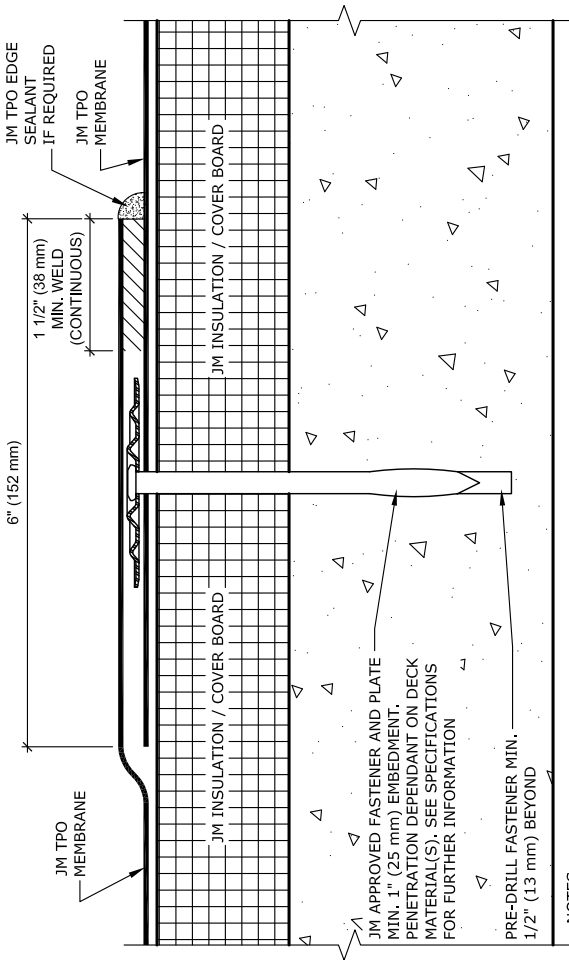

### Maximum Guarantee Term: 20 Year

Johns Manville is a manufacturer of commercial roofing products and offers this general conceptual information to you as a courtesy. This complimentary assistance is not to be used or relied upon by anyone as a substitute for professional engineering design and documentation required by building code, contract, or applicable law. By accepting these comments you agree they do not constitute any representations, endorsements of, or an assumption by Johns Manville of any liability for either the adequacy of design of this building or any other material not supplied by Johns Manville.

**Note:** For the most current information on general guidelines, please refer to the System Considerations tab under Commercial Roofing Products on the JM Roofing Web site. For specifications, flashing details and general installation information please refer to the Application Tools tab.

Refer to the Safe Use Instructions and product label prior to using this product.





## Continuous Strip Fastening Method

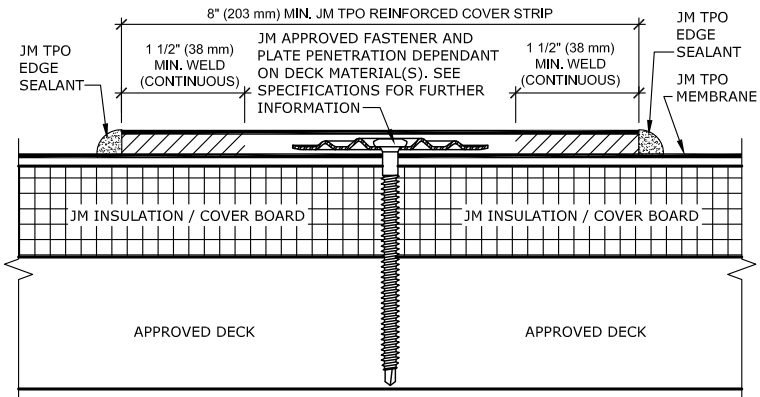
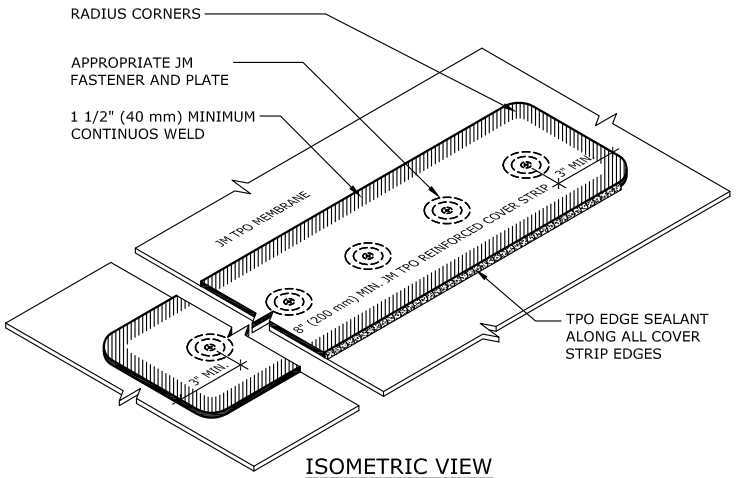

**NOTES:**

1. REFER TO JOHNS MANVILLE WEBSITE ([www.jm.com](http://www.jm.com)) FOR MOST UP-TO-DATE INFORMATION.
2. PLEASE SEE SINGLE PLY FLASHING SPECIFICATIONS FOR A FULL DESCRIPTION OF INSTALLATION INSTRUCTIONS AND REQUIREMENTS WHICH ARE CONSIDERED A PART OF THIS DETAIL.
3. ANY CARPENTRY OR METAL WORK SHOULD BE DESIGNED AND CONSTRUCTED IN ACCORDANCE WITH LOCAL CODE REQUIREMENTS AND/OR PROJECT SPECIFICATIONS. THESE COMPONENTS SHOULD BE REVIEWED AND APPROVED BY A LICENSED DESIGN PROFESSIONAL.
4. JM TPO EDGE SEALANT IS REQUIRED ON ALL CUT OR NON-ENCAPSULATED EDGES OF REINFORCED MEMBRANE. THIS INCLUDES FACTORY CUT MEMBRANE (SEE DETAIL T-MS-01).

### Maximum Guarantee Term: 20 Year

Johns Manville is a manufacturer of commercial roofing products and offers this general conceptual information to you as a courtesy. This complimentary assistance is not to be used or relied upon by anyone as a substitute for professional engineering design and documentation required by building code, contract, or applicable law. By accepting these comments you agree they do not constitute any representations, endorsements of, or an assumption by Johns Manville of any liability for either the adequacy of design of this building or any other material not supplied by Johns Manville.

**Note:** For the most current information on general guidelines, please refer to the System Considerations tab under Commercial Roofing Products on the JM Roofing Web site. For specifications, flashing details and general installation information please refer to the Application Tools tab.

Refer to the Safe Use Instructions and product label prior to using this product.



## Membrane Side Lap

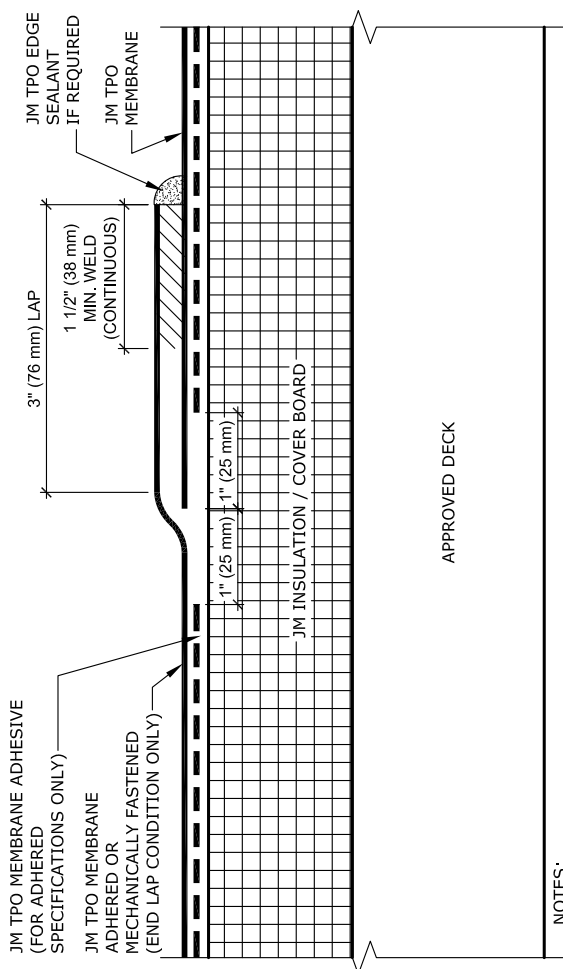

**NOTES:**

1. REFER TO JOHNS MANVILLE WEBSITE ([www.jm.com](http://www.jm.com)) FOR MOST UP-TO-DATE INFORMATION.
2. PLEASE SEE SINGLE PLY FLASHING SPECIFICATIONS FOR A FULL DESCRIPTION OF INSTALLATION INSTRUCTIONS AND REQUIREMENTS WHICH ARE CONSIDERED A PART OF THIS DETAIL.
3. ANY CARPENTRY OR METAL WORK SHOULD BE DESIGNED AND CONSTRUCTED IN ACCORDANCE WITH LOCAL CODE REQUIREMENTS AND/OR PROJECT SPECIFICATIONS. THESE COMPONENTS SHOULD BE REVIEWED AND APPROVED BY A LICENSED DESIGN PROFESSIONAL.
4. JM TPO EDGE SEALANT IS REQUIRED ON ALL CUT OR NON-ENCAPSULATED EDGES OF REINFORCED MEMBRANE. THIS INCLUDES FACTORY CUT MEMBRANE (SEE DETAIL T-MS-01).

### Maximum Guarantee Term: 30 Year

Johns Manville is a manufacturer of commercial roofing products and offers this general conceptual information to you as a courtesy. This complimentary assistance is not to be used or relied upon by anyone as a substitute for professional engineering design and documentation required by building code, contract, or applicable law. By accepting these comments you agree they do not constitute any representations, endorsements of, or an assumption by Johns Manville of any liability for either the adequacy of design of this building or any other material not supplied by Johns Manville.

**Note:** For the most current information on general guidelines, please refer to the System Considerations tab under Commercial Roofing Products on the JM Roofing Web site. For specifications, flashing details and general installation information please refer to the Application Tools tab.

Refer to the Safe Use Instructions and product label prior to using this product.



## TPO Fleece-Backed Adhesive Applied Membrane Butted End Lap

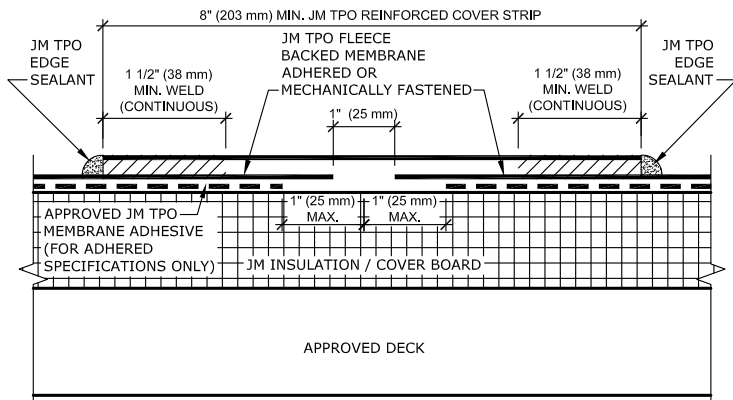
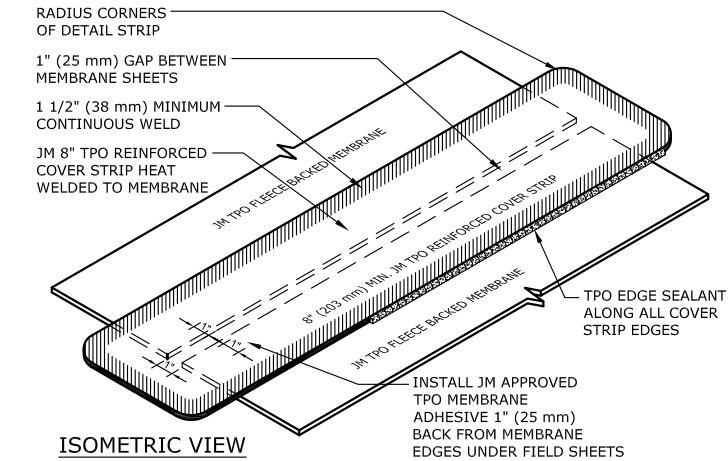

**NOTES:**

1. REFER TO JOHNS MANVILLE WEBSITE ([www.jm.com](http://www.jm.com)) FOR MOST UP-TO-DATE INFORMATION.
2. PLEASE SEE SINGLE PLY FLASHING SPECIFICATIONS FOR A FULL DESCRIPTION OF INSTALLATION INSTRUCTIONS AND REQUIREMENTS WHICH ARE CONSIDERED A PART OF THIS DETAIL.
3. ANY CARPENTRY OR METAL WORK SHOULD BE DESIGNED AND CONSTRUCTED IN ACCORDANCE WITH LOCAL CODE REQUIREMENTS AND/OR PROJECT SPECIFICATIONS. THESE COMPONENTS SHOULD BE REVIEWED AND APPROVED BY A LICENSED DESIGN PROFESSIONAL.
4. JM TPO EDGE SEALANT IS REQUIRED ON ALL CUT OR NON-ENCAPSULATED EDGES OF REINFORCED MEMBRANE. THIS INCLUDES FACTORY CUT MEMBRANE (SEE DETAIL T-MS-01).
5. APPROVED MEMBRANE ADHESIVES FOR USE WITH FLEECE BACKED MEMBRANE INCLUDE JM TPO MEMBRANE ADHESIVE (WATER BASED) ONE SIDED APPLICATION OR ROOFING SYSTEM URETHANE ADHESIVE (RSUA).

### Maximum Guarantee Term: 30 Year

Johns Manville is a manufacturer of commercial roofing products and offers this general conceptual information to you as a courtesy. This complimentary assistance is not to be used or relied upon by anyone as a substitute for professional engineering design and documentation required by building code, contract, or applicable law. By accepting these comments you agree they do not constitute any representations, endorsements of, or an assumption by Johns Manville of any liability for either the adequacy of design of this building or any other material not supplied by Johns Manville.

**Note:** For the most current information on general guidelines, please refer to the System Considerations tab under Commercial Roofing Products on the JM Roofing Web site. For specifications, flashing details and general installation information please refer to the Application Tools tab.

Refer to the Safe Use Instructions and product label prior to using this product.



## Slope Transition - Valley

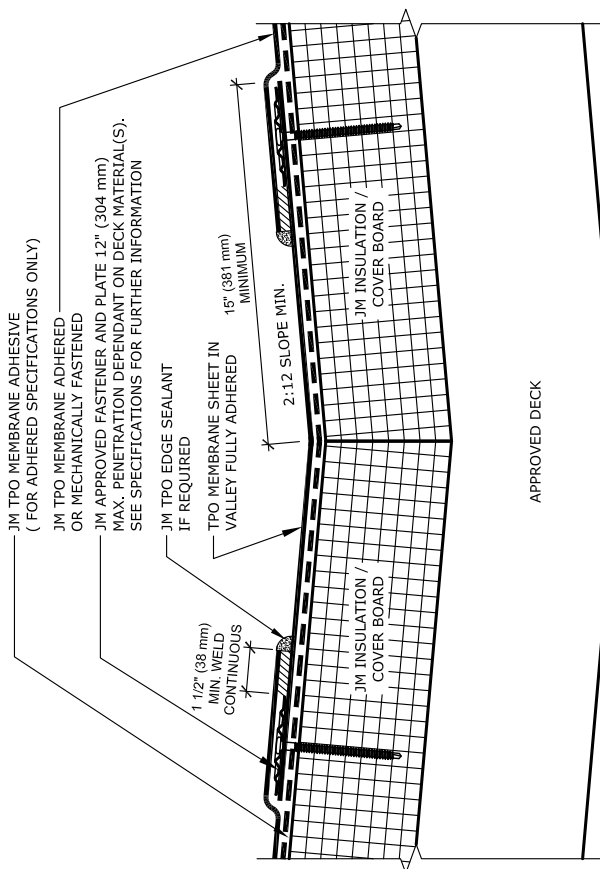

**NOTES:**

1. REFER TO JOHNS MANVILLE WEBSITE ([www.jm.com](http://www.jm.com)) FOR MOST UP-TO-DATE INFORMATION.
2. PLEASE SEE SINGLE PLY FLASHING SPECIFICATIONS FOR A FULL DESCRIPTION OF INSTALLATION INSTRUCTIONS AND REQUIREMENTS WHICH ARE CONSIDERED A PART OF THIS DETAIL.
3. ANY CARPENTRY OR METAL WORK SHOULD BE DESIGNED AND CONSTRUCTED IN ACCORDANCE WITH LOCAL CODE REQUIREMENTS AND/OR PROJECT SPECIFICATIONS. THESE COMPONENTS SHOULD BE REVIEWED AND APPROVED BY A LICENSED DESIGN PROFESSIONAL.
4. JM TPO EDGE SEALANT IS REQUIRED ON ALL CUT OR NON-ENCAPSULATED EDGES OF REINFORCED MEMBRANE. THIS INCLUDES FACTORY CUT MEMBRANE (SEE DETAIL T-MS-01).

### Maximum Guarantee Term: 30 Year

Johns Manville is a manufacturer of commercial roofing products and offers this general conceptual information to you as a courtesy. This complimentary assistance is not to be used or relied upon by anyone as a substitute for professional engineering design and documentation required by building code, contract, or applicable law. By accepting these comments you agree they do not constitute any representations, endorsements of, or an assumption by Johns Manville of any liability for either the adequacy of design of this building or any other material not supplied by Johns Manville.

**Note:** For the most current information on general guidelines, please refer to the System Considerations tab under Commercial Roofing Products on the JM Roofing Web site. For specifications, flashing details and general installation information please refer to the Application Tools tab.

Refer to the Safe Use Instructions and product label prior to using this product.



## Slope Transition - Ridge

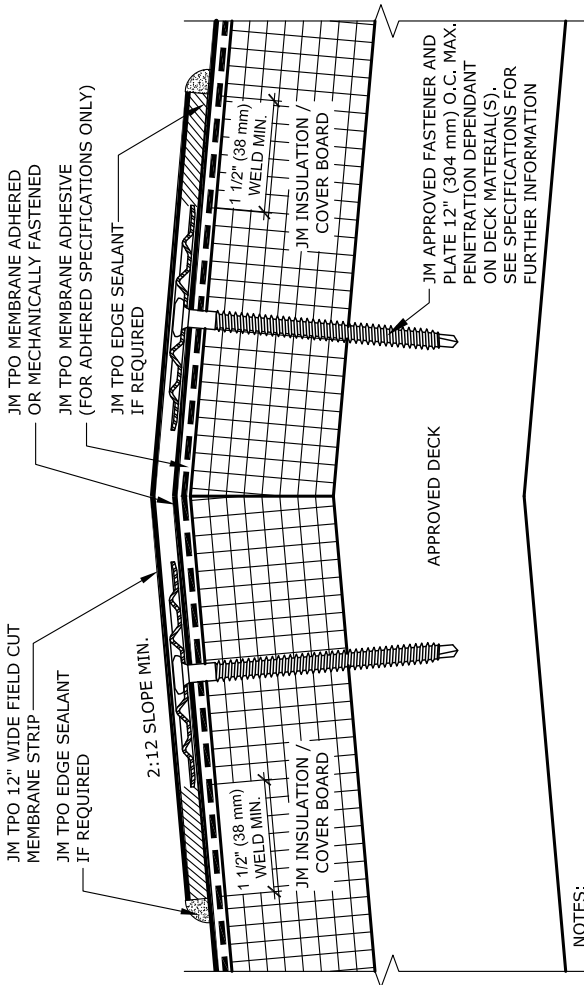

**NOTES:**

1. REFER TO JOHNS MANVILLE WEBSITE ([www.jm.com](http://www.jm.com)) FOR MOST UP-TO-DATE INFORMATION.
2. PLEASE SEE SINGLE PLY FLASHING SPECIFICATIONS FOR A FULL DESCRIPTION OF INSTALLATION INSTRUCTIONS AND REQUIREMENTS WHICH ARE CONSIDERED A PART OF THIS DETAIL.
3. ANY CARPENTRY OR METAL WORK SHOULD BE DESIGNED AND CONSTRUCTED IN ACCORDANCE WITH LOCAL CODE REQUIREMENTS AND/OR PROJECT SPECIFICATIONS. THESE COMPONENTS SHOULD BE REVIEWED AND APPROVED BY A LICENSED DESIGN PROFESSIONAL.
4. JM TPO EDGE SEALANT IS REQUIRED ON ALL CUT OR NON-ENCAPSULATED EDGES OF REINFORCED MEMBRANE. THIS INCLUDES FACTORY CUT MEMBRANE (SEE DETAIL T-MS-01).

### Maximum Guarantee Term: 30 Year

Johns Manville is a manufacturer of commercial roofing products and offers this general conceptual information to you as a courtesy. This complimentary assistance is not to be used or relied upon by anyone as a substitute for professional engineering design and documentation required by building code, contract, or applicable law. By accepting these comments you agree they do not constitute any representations, endorsements of, or an assumption by Johns Manville of any liability for either the adequacy of design of this building or any other material not supplied by Johns Manville.

**Note:** For the most current information on general guidelines, please refer to the System Considerations tab under Commercial Roofing Products on the JM Roofing Web site. For specifications, flashing details and general installation information please refer to the Application Tools tab.

Refer to the Safe Use Instructions and product label prior to using this product.



## Slope Transition - Ridge

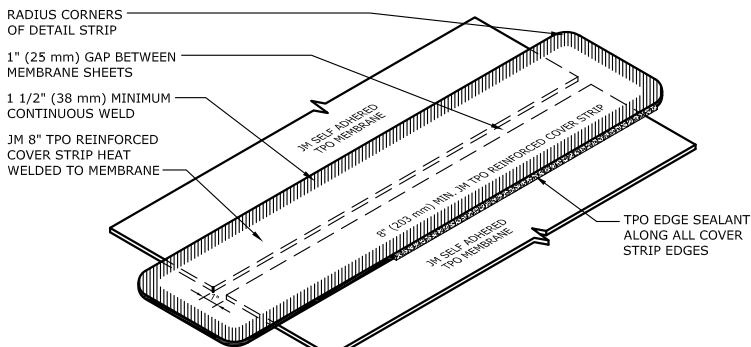

ISOMETRIC VIEW

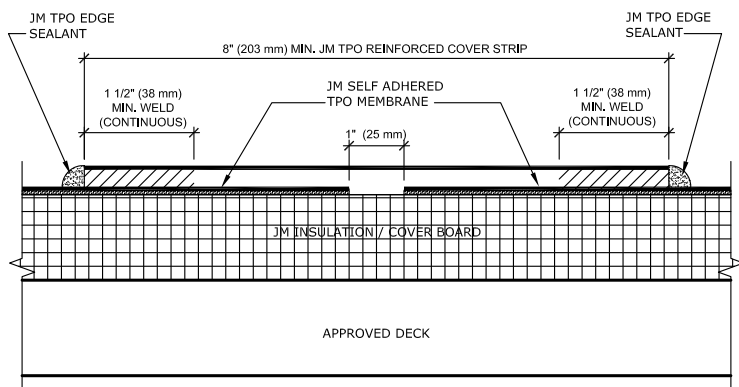

**NOTES:**

1. REFER TO JOHNS MANVILLE WEBSITE ([www.jm.com](http://www.jm.com)) FOR MOST UP-TO-DATE INFORMATION.
2. PLEASE SEE SINGLE PLY FLASHING SPECIFICATIONS FOR A FULL DESCRIPTION OF INSTALLATION INSTRUCTIONS AND REQUIREMENTS WHICH ARE CONSIDERED A PART OF THIS DETAIL.
3. ANY CARPENTRY OR METAL WORK SHOULD BE DESIGNED AND CONSTRUCTED IN ACCORDANCE WITH LOCAL CODE REQUIREMENTS AND/OR PROJECT SPECIFICATIONS. THESE COMPONENTS SHOULD BE REVIEWED AND APPROVED BY A LICENSED DESIGN PROFESSIONAL.
4. JM TPO EDGE SEALANT IS REQUIRED ON ALL CUT OR NON-ENCAPSULATED EDGES OF REINFORCED MEMBRANE. THIS INCLUDES FACTORY CUT MEMBRANE (SEE DETAIL T-MS-01).

## Maximum Guarantee Term: 20 Year

Johns Manville is a manufacturer of commercial roofing products and offers this general conceptual information to you as a courtesy. This complimentary assistance is not to be used or relied upon by anyone as a substitute for professional engineering design and documentation required by building code, contract, or applicable law. By accepting these comments you agree they do not constitute any representations, endorsements of, or an assumption by Johns Manville of any liability for either the adequacy of design of this building or any other material not supplied by Johns Manville.

**Note:** For the most current information on general guidelines, please refer to the System Considerations tab under Commercial Roofing Products on the JM Roofing Web site. For specifications, flashing details and general installation information please refer to the Application Tools tab.

Refer to the Safe Use Instructions and product label prior to using this product.





## Prefabricated Metal Curb Base Flashing

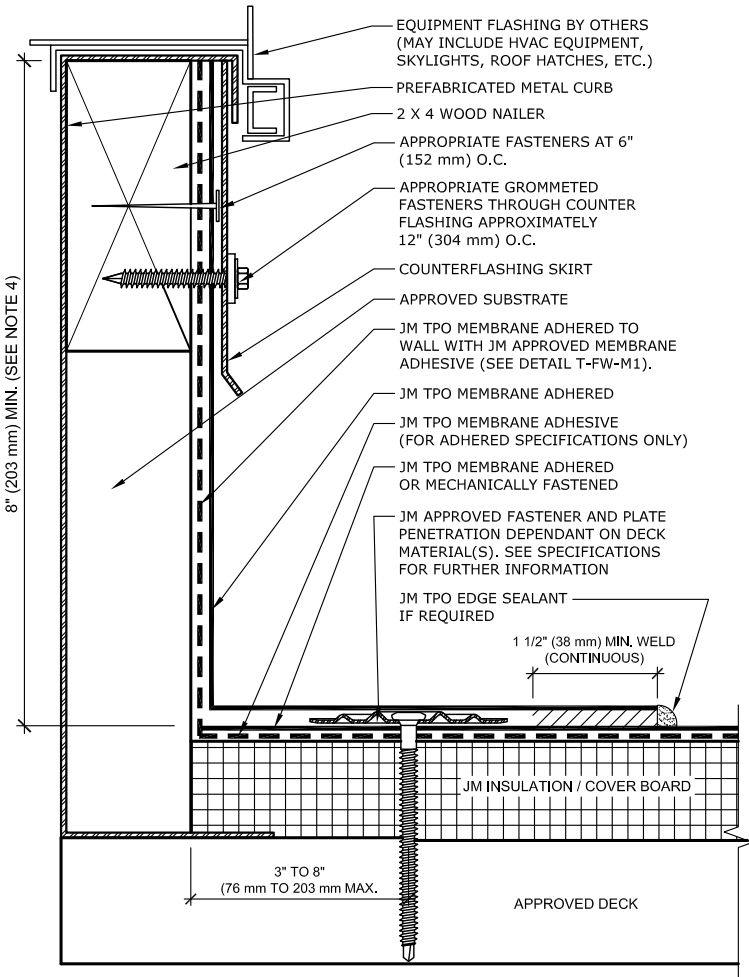

**NOTES:**

1. REFER TO JOHNS MANVILLE WEBSITE ([www.jm.com](http://www.jm.com)) FOR MOST UP-TO-DATE INFORMATION.
2. PLEASE SEE SINGLE PLY FLASHING SPECIFICATIONS FOR A FULL DESCRIPTION OF INSTALLATION INSTRUCTIONS AND REQUIREMENTS WHICH ARE CONSIDERED A PART OF THIS DETAIL.
3. ANY CARPENTRY OR METAL WORK SHOULD BE DESIGNED AND CONSTRUCTED IN ACCORDANCE WITH LOCAL CODE REQUIREMENTS AND/OR PROJECT SPECIFICATIONS. THESE COMPONENTS SHOULD BE REVIEWED AND APPROVED BY A LICENSED DESIGN PROFESSIONAL.
4. HEIGHT OF CURB TO BE ADJUSTED WITH NAILERS. IT IS PREFERRED TO RAISE CURB ONTO NAILERS TO EXTEND FLASHING HEIGHT.
5. TPO EDGE SEALANT IS REQUIRED ON ALL CUT AND NON ENCAPSULATED EDGES OF REINFORCED MEMBRANE. THIS INCLUDES FACTORY CUT MEMBRANE (SEE DETAIL T-MS-01).
6. SEE T-FW-B DETAILS FOR JM APPROVED BASE FLASHING TIE IN TERMINATION METHODS.

### Maximum Guarantee Term: 30 Year

Johns Manville is a manufacturer of commercial roofing products and offers this general conceptual information to you as a courtesy. This complimentary assistance is not to be used or relied upon by anyone as a substitute for professional engineering design and documentation required by building code, contract, or applicable law. By accepting these comments you agree they do not constitute any representations, endorsements of, or an assumption by Johns Manville of any liability for either the adequacy of design of this building or any other material not supplied by Johns Manville.

**Note:** For the most current information on general guidelines, please refer to the System Considerations tab under Commercial Roofing Products on the JM Roofing Web site. For specifications, flashing details and general installation information please refer to the Application Tools tab.

Refer to the Safe Use Instructions and product label prior to using this product.



## Roof Hatch

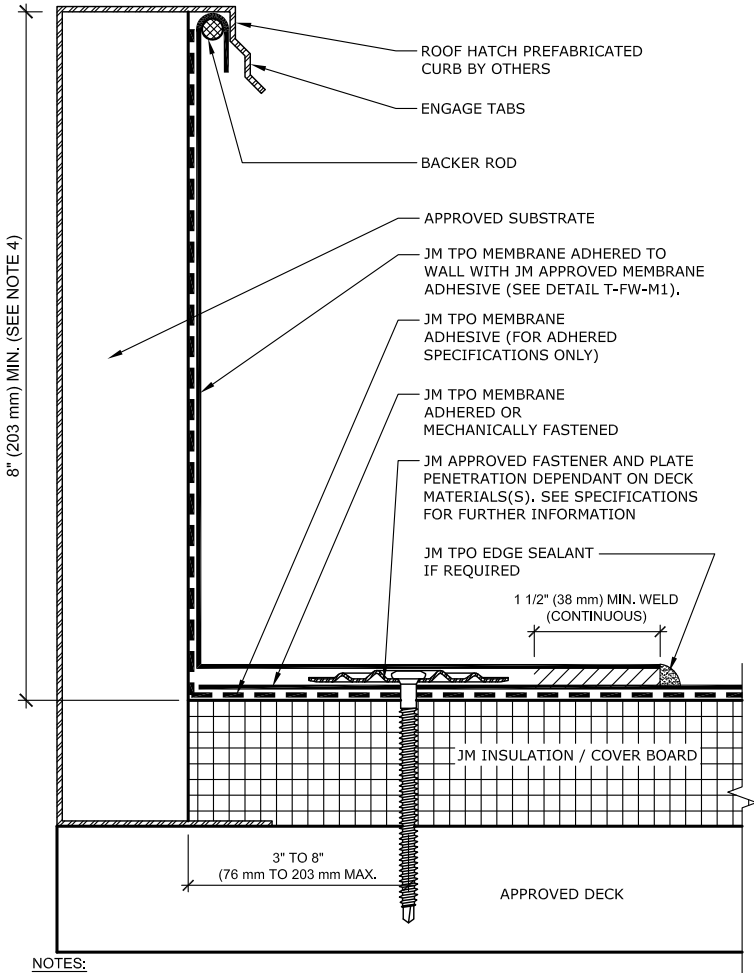

**NOTES:**

1. REFER TO JOHNS MANVILLE WEBSITE ([www.jm.com](http://www.jm.com)) FOR MOST UP-TO-DATE INFORMATION.
2. PLEASE SEE SINGLE PLY FLASHING SPECIFICATIONS FOR A FULL DESCRIPTION OF INSTALLATION INSTRUCTIONS AND REQUIREMENTS WHICH ARE CONSIDERED A PART OF THIS DETAIL.
3. ANY CARPENTRY OR METAL WORK SHOULD BE DESIGNED AND CONSTRUCTED IN ACCORDANCE WITH LOCAL CODE REQUIREMENTS AND/OR PROJECT SPECIFICATIONS, THESE COMPONENTS SHOULD BE REVIEWED AND APPROVED BY A LICENSED DESIGN PROFESSIONAL.
4. HEIGHT OF CURB TO BE ADJUSTED WITH NAILERS, IT IS PREFERRED TO RAISE CURB ONTO NAILERS TO EXTEND FLASHING HEIGHT.
5. TPO EDGE SEALANT IS REQUIRED ON ALL CUT AND NON ENCAPSULATED EDGES OF REINFORCED MEMBRANE, THIS INCLUDES FACTORY CUT MEMBRANE (SEE DETAIL T-MS-01).
6. SEE T-FW-B DETAILS FOR JM APPROVED BASE FLASHING TIE IN TERMINATION METHODS.

### Maximum Guarantee Term: 30 Year

Johns Manville is a manufacturer of commercial roofing products and offers this general conceptual information to you as a courtesy. This complimentary assistance is not to be used or relied upon by anyone as a substitute for professional engineering design and documentation required by building code, contract, or applicable law. By accepting these comments you agree they do not constitute any representations, endorsements of, or an assumption by Johns Manville of any liability for either the adequacy of design of this building or any other material not supplied by Johns Manville.

**Note:** For the most current information on general guidelines, please refer to the System Considerations tab under Commercial Roofing Products on the JM Roofing Web site. For specifications, flashing details and general installation information please refer to the Application Tools tab.

Refer to the Safe Use Instructions and product label prior to using this product.



## Outside Corner

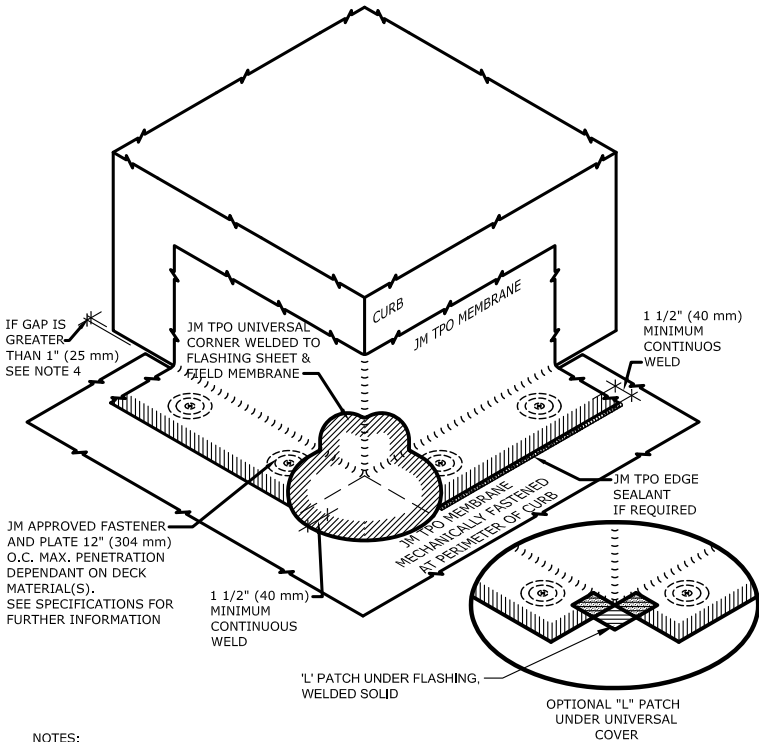

**NOTES:**

1. REFER TO JOHNS MANVILLE WEBSITE ([www.jm.com](http://www.jm.com)) FOR MOST UP-TO-DATE INFORMATION.
2. PLEASE SEE SINGLE PLY FLASHING SPECIFICATIONS FOR A FULL DESCRIPTION OF INSTALLATION INSTRUCTIONS AND REQUIREMENTS WHICH ARE CONSIDERED A PART OF THIS DETAIL.
3. ANY CARPENTRY OR METAL WORK SHOULD BE DESIGNED AND CONSTRUCTED IN ACCORDANCE WITH LOCAL CODE REQUIREMENTS AND/OR PROJECT SPECIFICATIONS. THESE COMPONENTS SHOULD BE REVIEWED AND APPROVED BY A LICENSED DESIGN PROFESSIONAL.
4. IF GAP OR CUT IN MEMBRANE IS GREATER THAN 1" UNDER TPO UNIVERSAL CORNER, AN "L" PATCH THAT EXTENDS OUT ONTO THE MEMBRANE A MINIMUM OF 2" MUST BE INSTALLED AT OUTSIDE CORNER. ("L" PATCH SHOWN AT RIGHT WITHOUT TPO UNIVERSAL CORNER)
5. JM TPO EDGE SEALANT IS REQUIRED ON ALL CUT OR NON ENCAPSULATED EDGES OF REINFORCED MEMBRANE. THIS INCLUDES FACTORY CUT MEMBRANE (SEE DETAIL T-MS-01).

## Maximum Guarantee Term: 30 Year

Johns Manville is a manufacturer of commercial roofing products and offers this general conceptual information to you as a courtesy. This complimentary assistance is not to be used or relied upon by anyone as a substitute for professional engineering design and documentation required by building code, contract, or applicable law. By accepting these comments you agree they do not constitute any representations, endorsements of, or an assumption by Johns Manville of any liability for either the adequacy of design of this building or any other material not supplied by Johns Manville.

**Note:** For the most current information on general guidelines, please refer to the System Considerations tab under Commercial Roofing Products on the JM Roofing Web site. For specifications, flashing details and general installation information please refer to the Application Tools tab.

Refer to the Safe Use Instructions and product label prior to using this product.



## Inside Corner

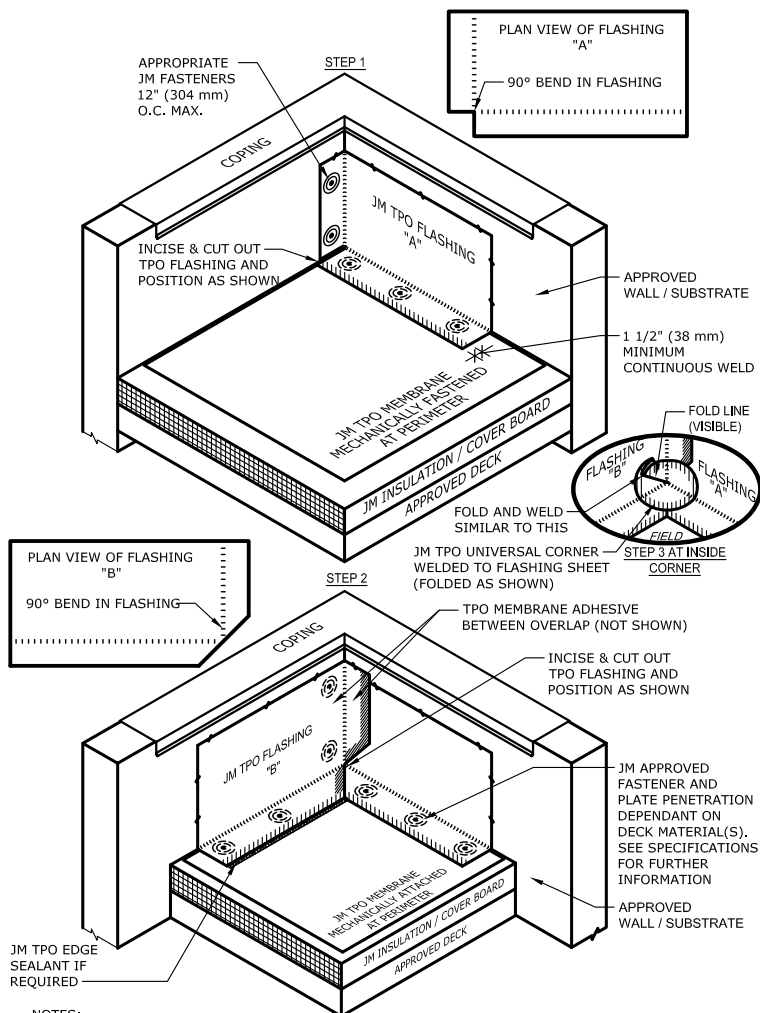

**NOTES:**

1. REFER TO JOHNS MANVILLE WEBSITE ([www.jm.com](http://www.jm.com)) FOR MOST UP-TO-DATE INFORMATION.
2. PLEASE SEE SINGLE PLY FLASHING SPECIFICATIONS FOR A FULL DESCRIPTION OF INSTALLATION INSTRUCTIONS AND REQUIREMENTS WHICH ARE CONSIDERED A PART OF THIS DETAIL.
3. ANY CARPENTRY OR METAL WORK SHOULD BE DESIGNED AND CONSTRUCTED IN ACCORDANCE WITH LOCAL CODE REQUIREMENTS AND/OR PROJECT SPECS. THESE COMPONENTS SHOULD BE REVIEWED AND APPROVED BY A LICENSED DESIGN PROFESSIONAL.
4. JM TPO EDGE SEALANT IS REQUIRED ON ALL CUT OR NON ENCAPSULATED EDGES OF REINFORCED MEMBRANE. THIS INCLUDES FACTORY CUT EDGES (SEE DETAIL T-MS-01).

## Maximum Guarantee Term: 30 Year

Johns Manville is a manufacturer of commercial roofing products and offers this general conceptual information to you as a courtesy. This complimentary assistance is not to be used or relied upon by anyone as a substitute for professional engineering design and documentation required by building code, contract, or applicable law. By accepting these comments you agree they do not constitute any representations, endorsements of, or an assumption by Johns Manville of any liability for either the adequacy of design of this building or any other material not supplied by Johns Manville.

**Note:** For the most current information on general guidelines, please refer to the System Considerations tab under Commercial Roofing Products on the JM Roofing Web site. For specifications, flashing details and general installation information please refer to the Application Tools tab.

Refer to the Safe Use Instructions and product label prior to using this product.



## TPO Wood Curb Base Flashing

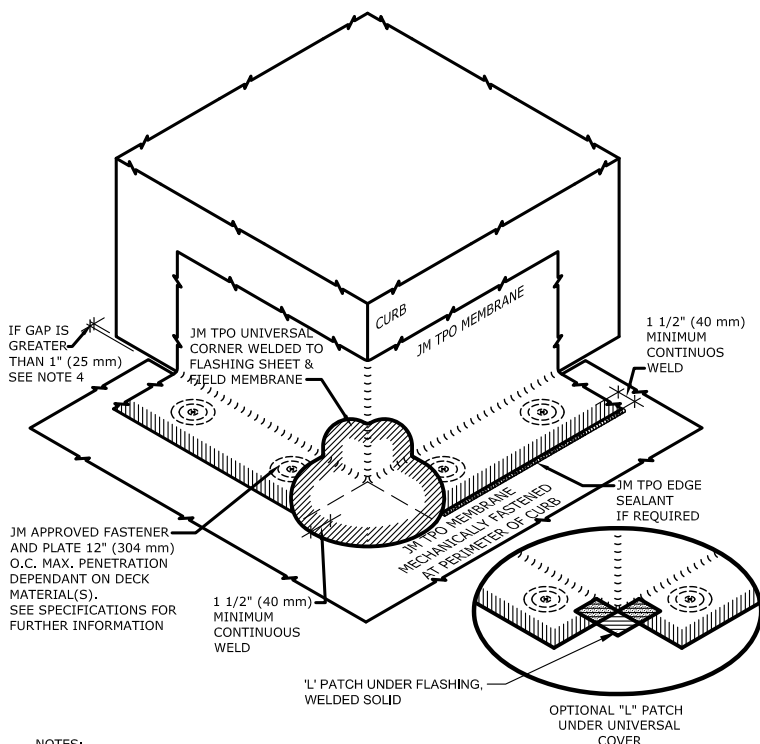

**NOTES:**

1. REFER TO JOHNS MANVILLE WEBSITE ([www.jm.com](http://www.jm.com)) FOR MOST UP-TO-DATE INFORMATION.
2. PLEASE SEE SINGLE PLY FLASHING SPECIFICATIONS FOR A FULL DESCRIPTION OF INSTALLATION INSTRUCTIONS AND REQUIREMENTS WHICH ARE CONSIDERED A PART OF THIS DETAIL.
3. ANY CARPENTRY OR METAL WORK SHOULD BE DESIGNED AND CONSTRUCTED IN ACCORDANCE WITH LOCAL CODE REQUIREMENTS AND/OR PROJECT SPECIFICATIONS. THESE COMPONENTS SHOULD BE REVIEWED AND APPROVED BY A LICENSED DESIGN PROFESSIONAL.
4. IF GAP OR CUT IN MEMBRANE IS GREATER THAN 1" UNDER TPO UNIVERSAL CORNER, AN "L" PATCH THAT EXTENDS OUT ONTO THE MEMBRANE A MINIMUM OF 2" MUST BE INSTALLED AT OUTSIDE CORNER. ("L" PATCH SHOWN AT RIGHT WITHOUT TPO UNIVERSAL CORNER)
5. JM TPO EDGE SEALANT IS REQUIRED ON ALL CUT OR NON ENCAPSULATED EDGES OF REINFORCED MEMBRANE. THIS INCLUDES FACTORY CUT MEMBRANE (SEE DETAIL T-MS-01).

### Maximum Guarantee Term: 30 Year

Johns Manville is a manufacturer of commercial roofing products and offers this general conceptual information to you as a courtesy. This complimentary assistance is not to be used or relied upon by anyone as a substitute for professional engineering design and documentation required by building code, contract, or applicable law. By accepting these comments you agree they do not constitute any representations, endorsements of, or an assumption by Johns Manville of any liability for either the adequacy of design of this building or any other material not supplied by Johns Manville.

**Note:** For the most current information on general guidelines, please refer to the System Considerations tab under Commercial Roofing Products on the JM Roofing Web site. For specifications, flashing details and general installation information please refer to the Application Tools tab.

Refer to the Safe Use Instructions and product label prior to using this product.



## Support - Light

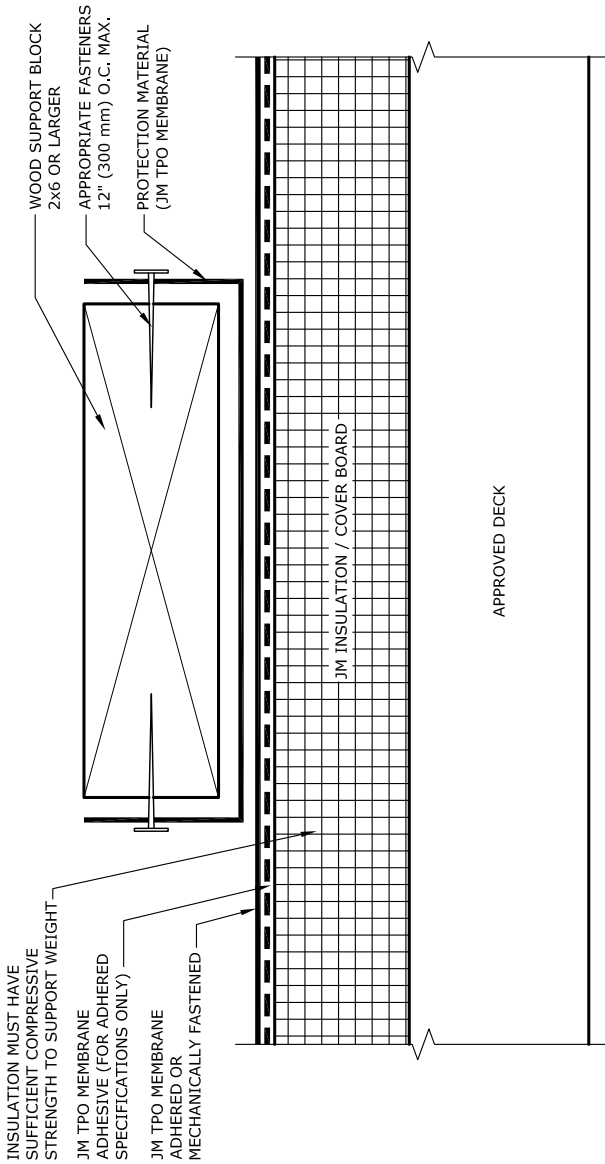

**NOTES:**

1. REFER TO JOHNS MANVILLE WEBSITE ([www.jm.com](http://www.jm.com)) FOR MOST UP-TO-DATE INFORMATION.
2. PLEASE SEE SINGLE PLY FLASHING SPECIFICATIONS FOR A FULL DESCRIPTION OF INSTALLATION INSTRUCTIONS AND REQUIREMENTS WHICH ARE CONSIDERED A PART OF THIS DETAIL.
3. ANY CARPENTRY OR METAL WORK SHOULD BE DESIGNED AND CONSTRUCTED IN ACCORDANCE WITH LOCAL CODE REQUIREMENTS AND/OR PROJECT SPECIFICATIONS. THESE COMPONENTS SHOULD BE REVIEWED AND APPROVED BY A LICENSED DESIGN PROFESSIONAL.

### Maximum Guarantee Term: 20 Year

Johns Manville is a manufacturer of commercial roofing products and offers this general conceptual information to you as a courtesy. This complimentary assistance is not to be used or relied upon by anyone as a substitute for professional engineering design and documentation required by building code, contract, or applicable law. By accepting these comments you agree they do not constitute any representations, endorsements of, or an assumption by Johns Manville of any liability for either the adequacy of design of this building or any other material not supplied by Johns Manville.

**Note:** For the most current information on general guidelines, please refer to the System Considerations tab under Commercial Roofing Products on the JM Roofing Web site. For specifications, flashing details and general installation information please refer to the Application Tools tab.

Refer to the Safe Use Instructions and product label prior to using this product.



## Support - Medium

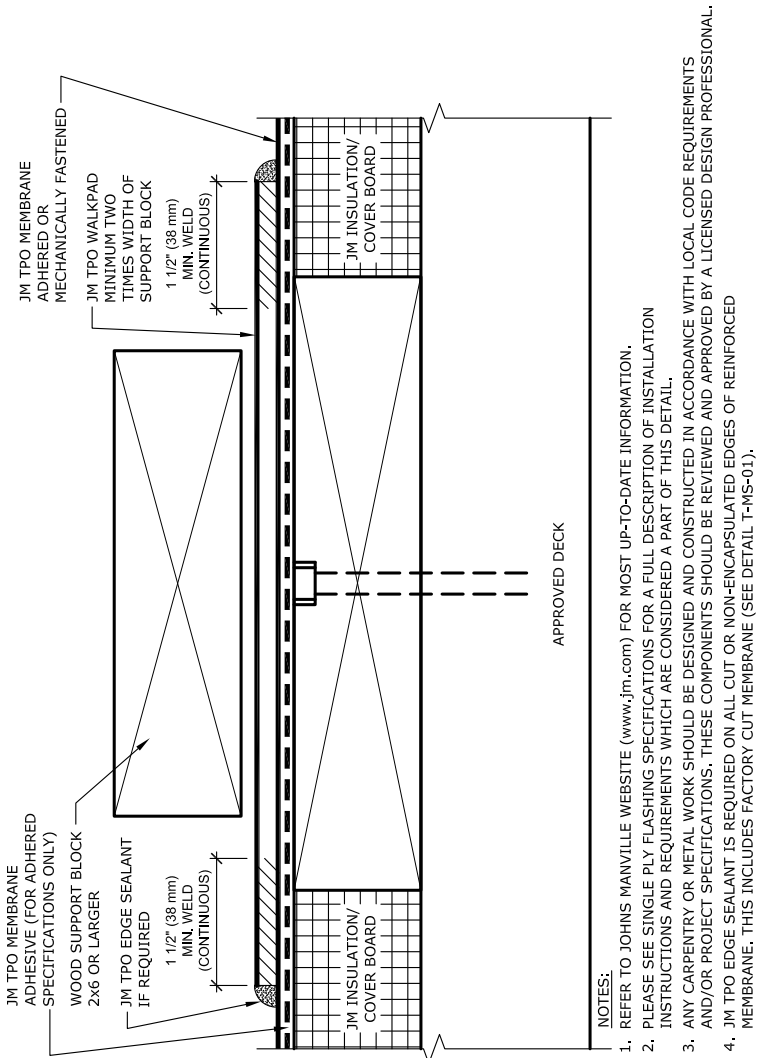

### Maximum Guarantee Term: 20 Year

Johns Manville is a manufacturer of commercial roofing products and offers this general conceptual information to you as a courtesy. This complimentary assistance is not to be used or relied upon by anyone as a substitute for professional engineering design and documentation required by building code, contract, or applicable law. By accepting these comments you agree they do not constitute any representations, endorsements of, or an assumption by Johns Manville of any liability for either the adequacy of design of this building or any other material not supplied by Johns Manville.

**Note:** For the most current information on general guidelines, please refer to the System Considerations tab under Commercial Roofing Products on the JM Roofing Web site. For specifications, flashing details and general installation information please refer to the Application Tools tab.

Refer to the Safe Use Instructions and product label prior to using this product.



## Support - Heavy

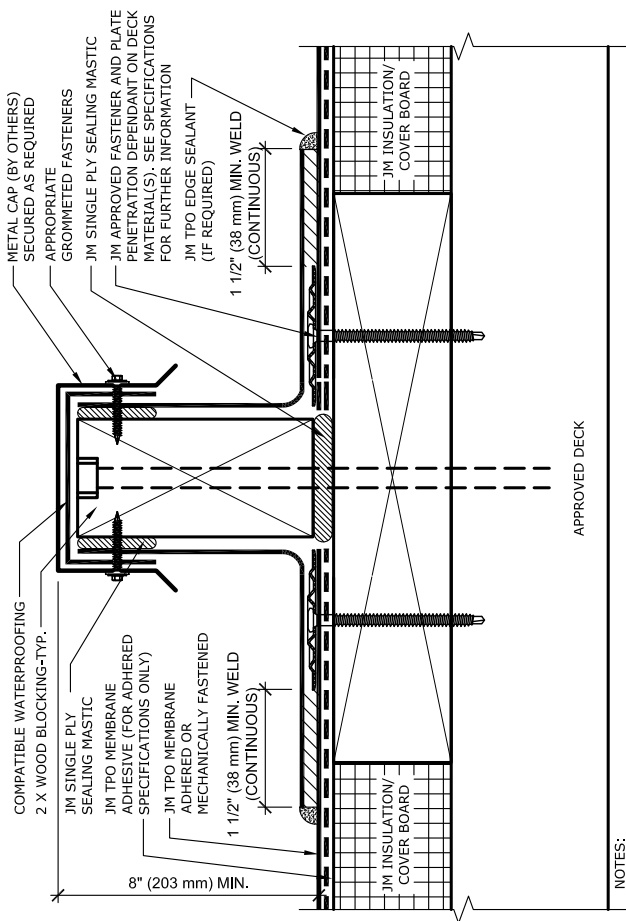

- NOTES:**
1. REFER TO JOHNS MANVILLE WEBSITE ([www.jm.com](http://www.jm.com)) FOR MOST UP-TO-DATE INFORMATION.
  2. PLEASE SEE SINGLE PLY FLASHING SPECIFICATIONS FOR A FULL DESCRIPTION OF INSTALLATION INSTRUCTIONS AND REQUIREMENTS WHICH ARE CONSIDERED A PART OF THIS DETAIL.
  3. ANY CARPENTRY OR METAL WORK SHOULD BE DESIGNED AND CONSTRUCTED IN ACCORDANCE WITH LOCAL CODE REQUIREMENTS AND/OR PROJECT SPECIFICATIONS. THESE COMPONENTS SHOULD BE REVIEWED AND APPROVED BY A LICENSED DESIGN PROFESSIONAL.
  4. JM TPO EDGE SEALANT IS REQUIRED ON ALL CUT OR NON-ENCAPSULATED EDGES OF REINFORCED MEMBRANE. THIS INCLUDES FACTORY CUT MEMBRANE (SEE DETAIL T-MS-01).

TPO Flashing Details

### Maximum Guarantee Term: 20 Year

Johns Manville is a manufacturer of commercial roofing products and offers this general conceptual information to you as a courtesy. This complimentary assistance is not to be used or relied upon by anyone as a substitute for professional engineering design and documentation required by building code, contract, or applicable law. By accepting these comments you agree they do not constitute any representations, endorsements of, or an assumption by Johns Manville of any liability for either the adequacy of design of this building or any other material not supplied by Johns Manville.

**Note:** For the most current information on general guidelines, please refer to the System Considerations tab under Commercial Roofing Products on the JM Roofing Web site. For specifications, flashing details and general installation information please refer to the Application Tools tab.

Refer to the Safe Use Instructions and product label prior to using this product.





## Walkway - Concrete Paver

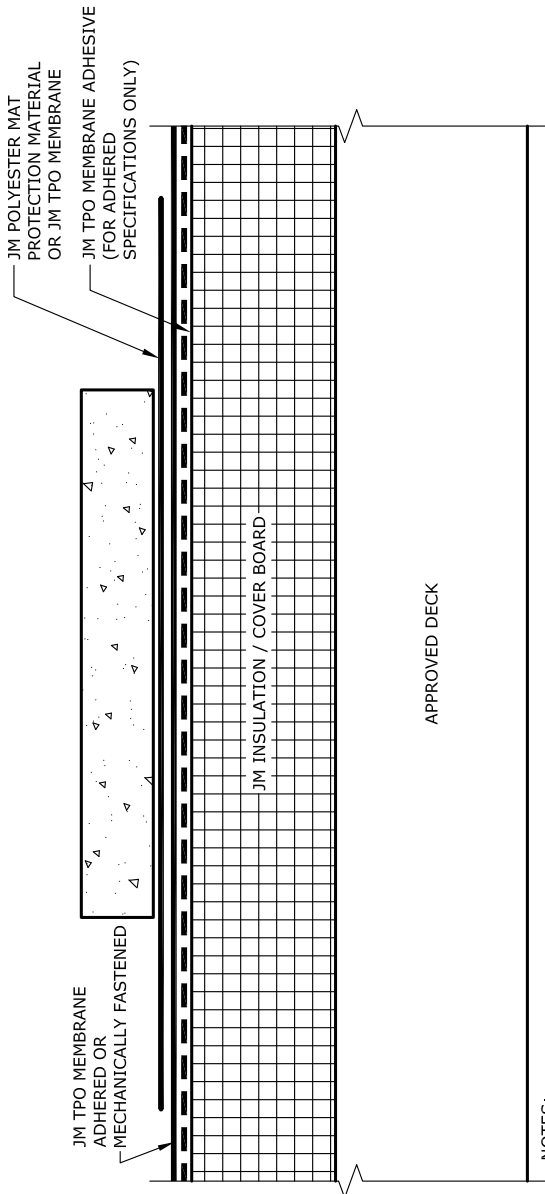

**NOTES:**

1. REFER TO JOHNS MANVILLE WEBSITE ([www.jm.com](http://www.jm.com)) FOR MOST UP-TO-DATE INFORMATION.
2. PLEASE SEE SINGLE PLY FLASHING SPECIFICATIONS FOR A FULL DESCRIPTION OF INSTALLATION INSTRUCTIONS AND REQUIREMENTS WHICH ARE CONSIDERED A PART OF THIS DETAIL.
3. ANY CARPENTRY OR METAL WORK SHOULD BE DESIGNED AND CONSTRUCTED IN ACCORDANCE WITH LOCAL CODE REQUIREMENTS AND/OR PROJECT SPECIFICATIONS. THESE COMPONENTS SHOULD BE REVIEWED AND APPROVED BY A LICENSED DESIGN PROFESSIONAL.

Johns Manville is a manufacturer of commercial roofing products and offers this general conceptual information to you as a courtesy. This complimentary assistance is not to be used or relied upon by anyone as a substitute for professional engineering design and documentation required by building code, contract, or applicable law. By accepting these comments you agree they do not constitute any representations, endorsements of, or an assumption by Johns Manville of any liability for either the adequacy of design of this building or any other material not supplied by Johns Manville.

**Note:** For the most current information on general guidelines, please refer to the System Considerations tab under Commercial Roofing Products on the JM Roofing Web site. For specifications, flashing details and general installation information please refer to the Application Tools tab.

Refer to the Safe Use Instructions and product label prior to using this product.



## TPO Walkpads Over Adhered TPO Membrane

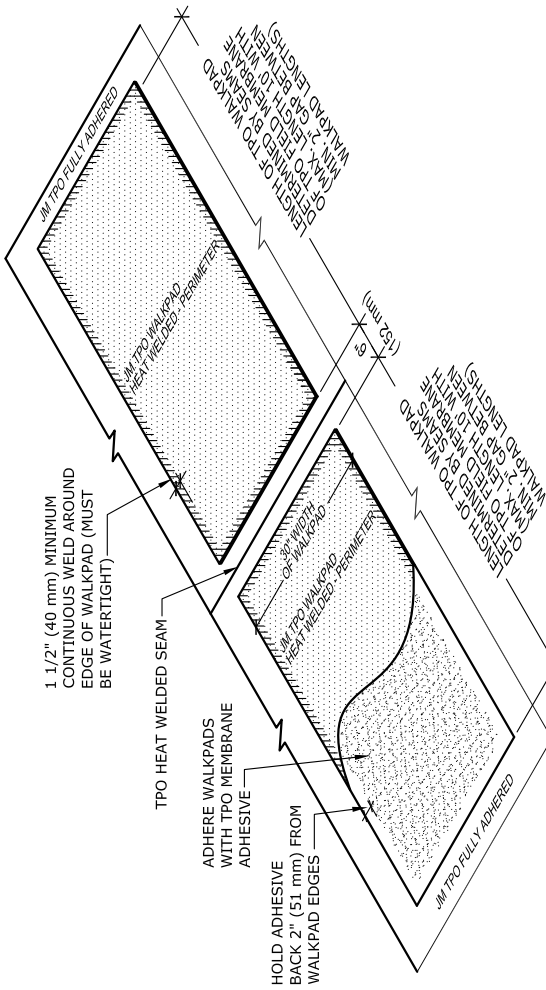

**NOTES:**

1. REFER TO JOHNS MANVILLE WEBSITE ([www.jm.com](http://www.jm.com)) FOR MOST UP-TO-DATE INFORMATION.
2. PLEASE SEE SINGLE PLY FLASHING SPECIFICATIONS FOR A FULL DESCRIPTION OF INSTALLATION INSTRUCTIONS AND REQUIREMENTS WHICH ARE CONSIDERED A PART OF THIS DETAIL.
3. ANY CARPENTRY OR METAL WORK SHOULD BE DESIGNED AND CONSTRUCTED IN ACCORDANCE WITH LOCAL CODE REQUIREMENTS AND/OR PROJECT SPECIFICATIONS. THESE COMPONENTS SHOULD BE REVIEWED AND APPROVED BY A LICENSED DESIGN PROFESSIONAL.
4. JM TPO EDGE SEALANT IS REQUIRED ON ALL CUT OR NON-ENCAPSULATED EDGES OF REINFORCED MEMBRANE. THIS INCLUDES FACTORY CUT MEMBRANE (SEE DETAIL T-MS-01).
5. CLEAN MEMBRANE SURFACE PRIOR TO WALKPAD INSTALLATION WITH TPO MEMBRANE CLEANER.
6. DO NOT INSTALL WALKPADS OVER MEMBRANE SEAMS.

### Maximum Guarantee Term: 20 Year

Johns Manville is a manufacturer of commercial roofing products and offers this general conceptual information to you as a courtesy. This complimentary assistance is not to be used or relied upon by anyone as a substitute for professional engineering design and documentation required by building code, contract, or applicable law. By accepting these comments you agree they do not constitute any representations, endorsements of, or an assumption by Johns Manville of any liability for either the adequacy of design of this building or any other material not supplied by Johns Manville.

**Note:** For the most current information on general guidelines, please refer to the System Considerations tab under Commercial Roofing Products on the JM Roofing Web site. For specifications, flashing details and general installation information please refer to the Application Tools tab.

Refer to the Safe Use Instructions and product label prior to using this product.



## TPO Walkpad Fleece-Backed System Adhered

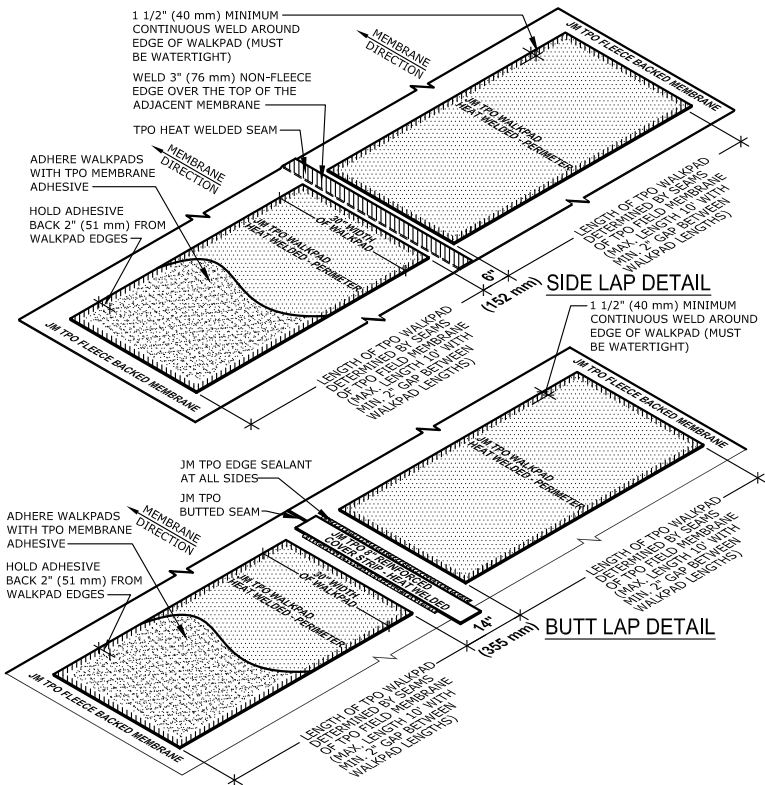

**NOTES:**

1. REFER TO JOHNS MANVILLE WEBSITE ([www.jm.com](http://www.jm.com)) FOR MOST UP-TO-DATE INFORMATION.
2. PLEASE SEE SINGLE PLY FLASHING SPECIFICATIONS FOR A FULL DESCRIPTION OF INSTALLATION INSTRUCTIONS AND REQUIREMENTS WHICH ARE CONSIDERED A PART OF THIS DETAIL.
3. ANY CARPENTRY OR METAL WORK SHOULD BE DESIGNED AND CONSTRUCTED IN ACCORDANCE WITH LOCAL CODE REQUIREMENTS AND/OR PROJECT SPECIFICATIONS. THESE COMPONENTS SHOULD BE REVIEWED AND APPROVED BY A LICENSED DESIGN PROFESSIONAL.
4. JM TPO EDGE SEALANT IS REQUIRED ON ALL CUT OR NON ENCAPSULATED EDGES OF REINFORCED MEMBRANE. THIS INCLUDES FACTORY CUT MEMBRANE (SEE DETAIL T-MS-01).
5. DO NOT INSTALL WALKPADS OVER MEMBRANE SEAMS.

### Maximum Guarantee Term: 20 Year

Johns Manville is a manufacturer of commercial roofing products and offers this general conceptual information to you as a courtesy. This complimentary assistance is not to be used or relied upon by anyone as a substitute for professional engineering design and documentation required by building code, contract, or applicable law. By accepting these comments you agree they do not constitute any representations, endorsements of, or an assumption by Johns Manville of any liability for either the adequacy of design of this building or any other material not supplied by Johns Manville.

**Note:** For the most current information on general guidelines, please refer to the System Considerations tab under Commercial Roofing Products on the JM Roofing Web site. For specifications, flashing details and general installation information please refer to the Application Tools tab.

Refer to the Safe Use Instructions and product label prior to using this product.



## TPO Walkpad Over Mechanically Fastened TPO Membrane

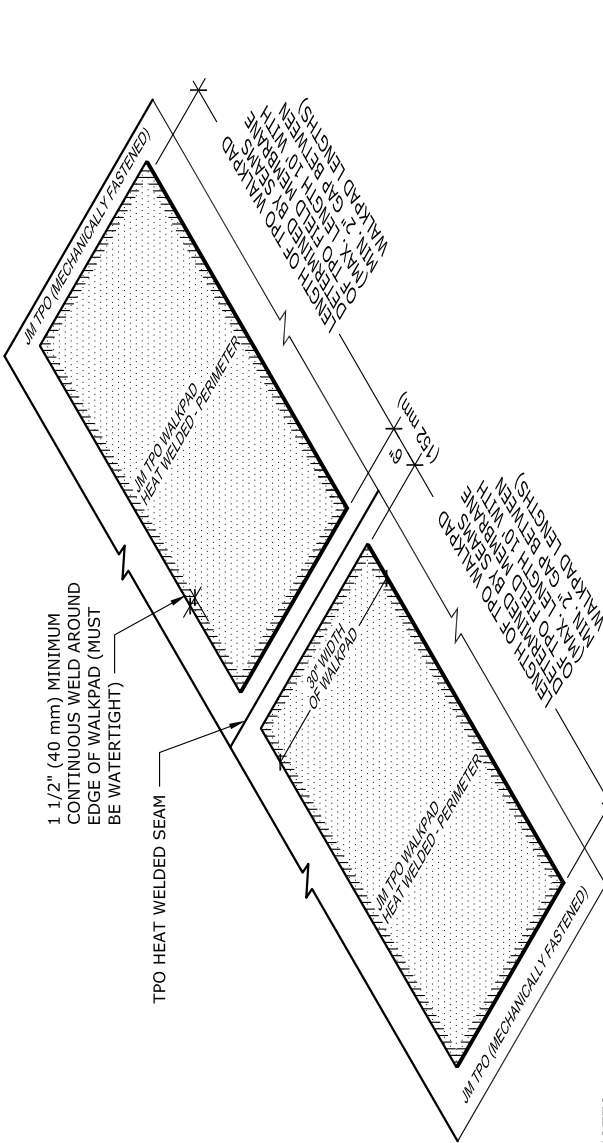

**NOTES:**

1. REFER TO JOHNS MANVILLE WEBSITE ([www.jm.com](http://www.jm.com)) FOR MOST UP-TO-DATE INFORMATION.
2. PLEASE SEE SINGLE PLY FLASHING SPECIFICATIONS FOR A FULL DESCRIPTION OF INSTALLATION INSTRUCTIONS AND REQUIREMENTS WHICH ARE CONSIDERED A PART OF THIS DETAIL.
3. ANY CARPENTRY OR METAL WORK SHOULD BE DESIGNED AND CONSTRUCTED IN ACCORDANCE WITH LOCAL CODE REQUIREMENTS AND/OR PROJECT SPECIFICATIONS. THESE COMPONENTS SHOULD BE REVIEWED AND APPROVED BY A LICENSED DESIGN PROFESSIONAL.
4. DO NOT INSTALL WALKPADS OVER MEMBRANE SEAMS.

### Maximum Guarantee Term: 20 Year

Johns Manville is a manufacturer of commercial roofing products and offers this general conceptual information to you as a courtesy. This complimentary assistance is not to be used or relied upon by anyone as a substitute for professional engineering design and documentation required by building code, contract, or applicable law. By accepting these comments you agree they do not constitute any representations, endorsements of, or an assumption by Johns Manville of any liability for either the adequacy of design of this building or any other material not supplied by Johns Manville.

**Note:** For the most current information on general guidelines, please refer to the System Considerations tab under Commercial Roofing Products on the JM Roofing Web site. For specifications, flashing details and general installation information please refer to the Application Tools tab.

Refer to the Safe Use Instructions and product label prior to using this product.



## Lightning Rod - Wall Mount

JM DOES NOT EVALUATE OR RECOMMEND ANY LIGHTNING PROTECTION MANUFACTURERS PRODUCTS. THE LIGHTNING PROTECTION DEVICES SHOWN ARE FOR GRAPHIC REPRESENTATION ONLY.

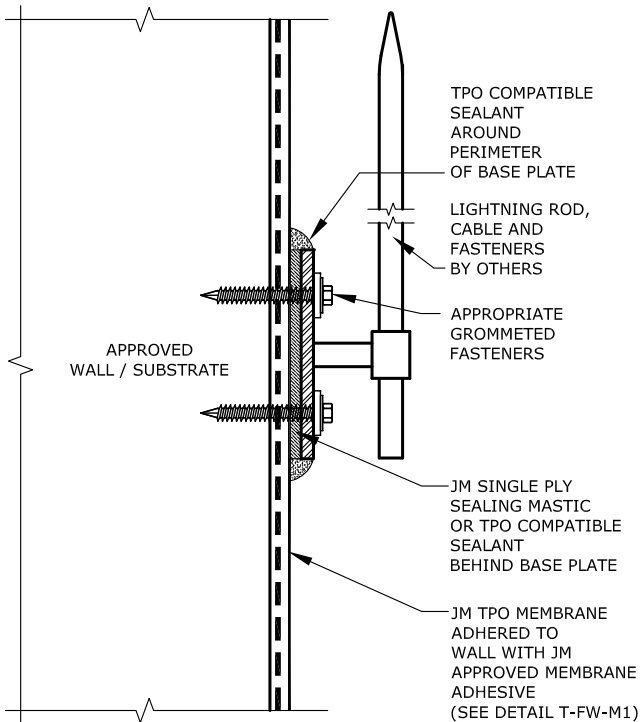

### NOTES:

1. REFER TO JOHNS MANVILLE WEBSITE ([www.jm.com](http://www.jm.com)) FOR MOST UP-TO-DATE INFORMATION.
2. PLEASE SEE SINGLE PLY FLASHING SPECIFICATIONS FOR A FULL DESCRIPTION OF INSTALLATION INSTRUCTIONS AND REQUIREMENTS WHICH ARE CONSIDERED A PART OF THIS DETAIL.
3. ANY CARPENTRY OR METAL WORK SHOULD BE DESIGNED AND CONSTRUCTED IN ACCORDANCE WITH LOCAL CODE REQUIREMENTS AND/OR PROJECT SPECIFICATIONS. THESE COMPONENTS SHOULD BE REVIEWED AND APPROVED BY A LICENSED DESIGN PROFESSIONAL. JM ASSUMES NO RESPONSIBILITY FOR THE INSTALLATION OF LIGHTNING RODS AND ASSOCIATED COMPONENTS OR FOR DAMAGE TO THE ROOF SYSTEM DUE TO FAULTY INSTALLATION OR DETACHMENT FROM SAID SYSTEM.
4. JM TPO EDGE SEALANT IS REQUIRED ON ALL CUT OR NON-ENCAPSULATED EDGES OF REINFORCED MEMBRANE. THIS INCLUDES FACTORY CUT MEMBRANE (SEE DETAIL T-MS-01).
5. LIGHTNING ROD GROUND WIRE MUST NOT COME IN CONTACT WITH THE ROOFING MEMBRANE.

Johns Manville is a manufacturer of commercial roofing products and offers this general conceptual information to you as a courtesy. This complimentary assistance is not to be used or relied upon by anyone as a substitute for professional engineering design and documentation required by building code, contract, or applicable law. By accepting these comments you agree they do not constitute any representations, endorsements of, or an assumption by Johns Manville of any liability for either the adequacy of design of this building or any other material not supplied by Johns Manville.

**Note:** For the most current information on general guidelines, please refer to the System Considerations tab under Commercial Roofing Products on the JM Roofing Web site. For specifications, flashing details and general installation information please refer to the Application Tools tab.

Refer to the Safe Use Instructions and product label prior to using this product.



## Lightning Rod - Roof Mount

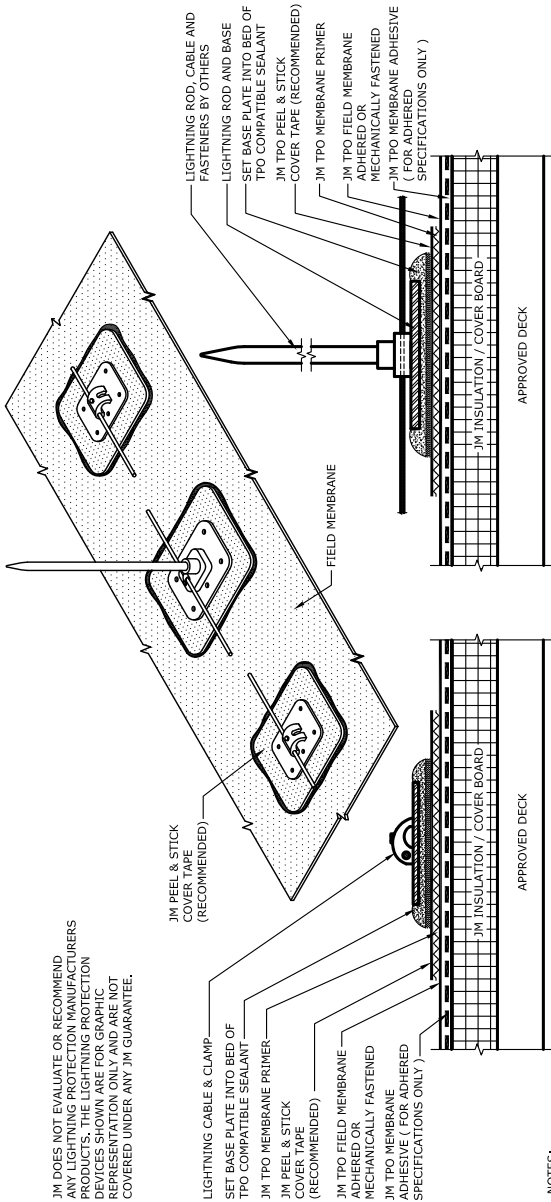

JM DOES NOT EVALUATE OR RECOMMEND ANY LIGHTNING PROTECTION MANUFACTURERS PRODUCTS. THE LIGHTNING PROTECTION DEVICES SHOWN ARE FOR GRAPHIC REPRESENTATION ONLY AND ARE NOT COVERED UNDER ANY JM GUARANTEE.

NOTES:  
1. REFER TO JOHNS MANVILLE WEBSITE ([www.jm.com](http://www.jm.com)) FOR MOST UP-TO-DATE INFORMATION.

- PLEASE SEE SINGLE PLY FLASHING SPECIFICATIONS FOR A FULL DESCRIPTION OF INSTALLATION INSTRUCTIONS AND REQUIREMENTS WHICH ARE CONSIDERED A PART OF THIS DETAIL.
- ANY CARPENTRY OR METAL WORK SHOULD BE DESIGNED AND CONSTRUCTED IN ACCORDANCE WITH LOCAL CODE REQUIREMENTS AND/OR PROJECT SPECIFICATIONS. THESE COMPONENTS SHOULD BE REVIEWED AND APPROVED BY A LICENSED DESIGN PROFESSIONAL. JM ASSUMES NO RESPONSIBILITY FOR THE INSTALLATION OF LIGHTNING RODS AND ASSOCIATED COMPONENTS OR FOR DAMAGE TO THE ROOF SYSTEM DUE TO FAULTY INSTALLATION OR DETACHMENT FROM SAID SYSTEM.
- JM TPO EDGE SEALANT IS REQUIRED ON ALL CUT OR NON-ENCAPSULATED EDGES OF REINFORCED MEMBRANE. THIS INCLUDES FACTORY CUT MEMBRANE (SEE DETAIL T-MS-01).
- LIGHTNING ROD GROUND WIRE MUST NOT COME IN CONTACT WITH THE ROOFING MEMBRANE. A SACRIFICIAL LAYER OF MEMBRANE IS RECOMMENDED UNDER THE ENTIRE LENGTH OF GROUND WIRE(S).
- ALL SEALANTS / CAULKING SHALL BE PERIODICALLY INSPECTED AND MAINTAINED BY THE BUILDING OWNER THROUGHOUT THE LIFE OF THE ROOF.
- PRIME UNDERSIDE OF FIELD MEMBRANE AT PEEL & STICK SECTION WITH JM TPO MEMBRANE PRIMER OR JM SINGLE PLY MEMBRANE PRIMER (LOW VOC).
- ROLL TPO MEMBRANE WITH ROLLER UNDER PRESSURE AT PEEL & STICK SECTION OR RTS.

Johns Manville is a manufacturer of commercial roofing products and offers this general conceptual information to you as a courtesy. This complimentary assistance is not to be used or relied upon by anyone as a substitute for professional engineering design and documentation required by building code, contract, or applicable law. By accepting these comments you agree they do not constitute any representations, endorsements of, or an assumption by Johns Manville of any liability for either the adequacy of design of this building or any other material not supplied by Johns Manville.

**Note:** For the most current information on general guidelines, please refer to the System Considerations tab under Commercial Roofing Products on the JM Roofing Web site. For specifications, flashing details and general installation information please refer to the Application Tools tab.

Refer to the Safe Use Instructions and product label prior to using this product.



## Grease Trap

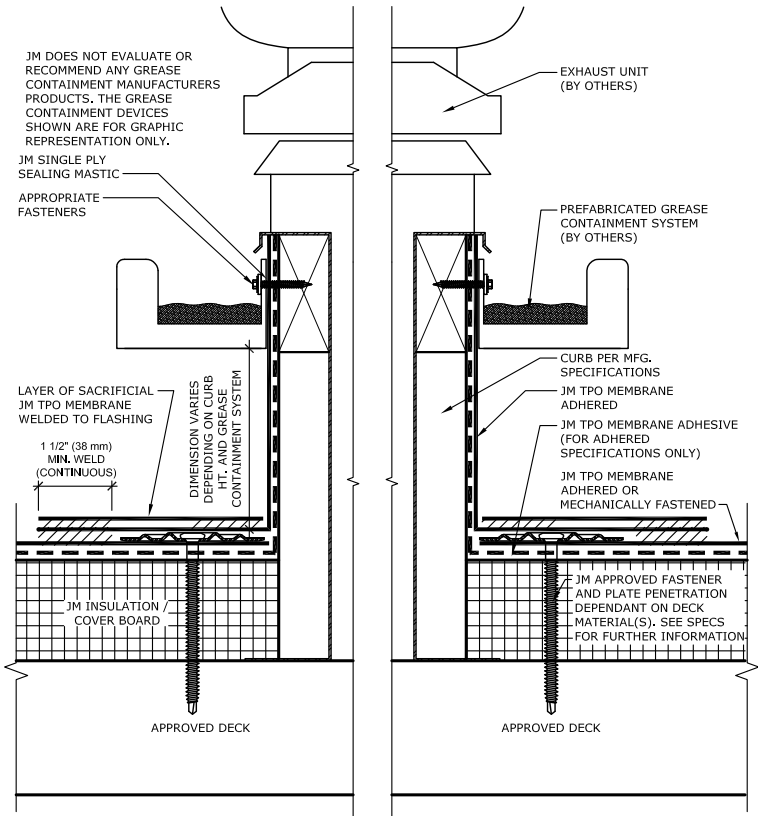

**NOTES:**

1. REFER TO JOHNS MANVILLE WEBSITE ([www.jm.com](http://www.jm.com)) FOR MOST UP-TO-DATE INFORMATION.
2. PLEASE SEE SINGLE PLY FLASHING SPECIFICATIONS FOR A FULL DESCRIPTION OF INSTALLATION INSTRUCTIONS AND REQUIREMENTS WHICH ARE CONSIDERED A PART OF THIS DETAIL.
3. ANY CARPENTRY OR METAL WORK SHOULD BE DESIGNED AND CONSTRUCTED IN ACCORDANCE WITH LOCAL CODE REQUIREMENTS AND/OR PROJECT SPECIFICATIONS. THESE COMPONENTS SHOULD BE REVIEWED AND APPROVED BY A LICENSED DESIGN PROFESSIONAL.
4. ANY DAMAGE TO THE ROOF SYSTEM THAT RESULTS FROM IMPROPER MAINTENANCE OR IMPROPER SIZING OF TRAP IS NOT GUARANTEEABLE.

### Maximum Guarantee Term: 20 Year

Johns Manville is a manufacturer of commercial roofing products and offers this general conceptual information to you as a courtesy. This complimentary assistance is not to be used or relied upon by anyone as a substitute for professional engineering design and documentation required by building code, contract, or applicable law. By accepting these comments you agree they do not constitute any representations, endorsements of, or an assumption by Johns Manville of any liability for either the adequacy of design of this building or any other material not supplied by Johns Manville.

**Note:** For the most current information on general guidelines, please refer to the System Considerations tab under Commercial Roofing Products on the JM Roofing Web site. For specifications, flashing details and general installation information please refer to the Application Tools tab.

Refer to the Safe Use Instructions and product label prior to using this product.

TPO Flashing Details



## JM Single Ply Safety Strip Over TPO Membrane

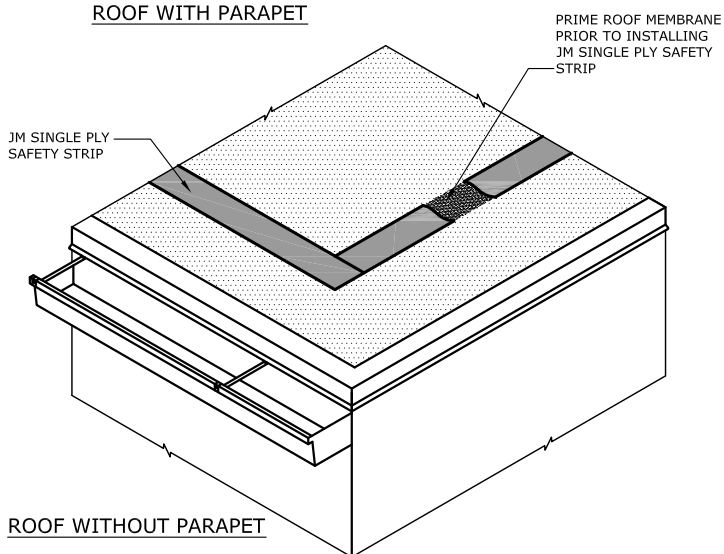
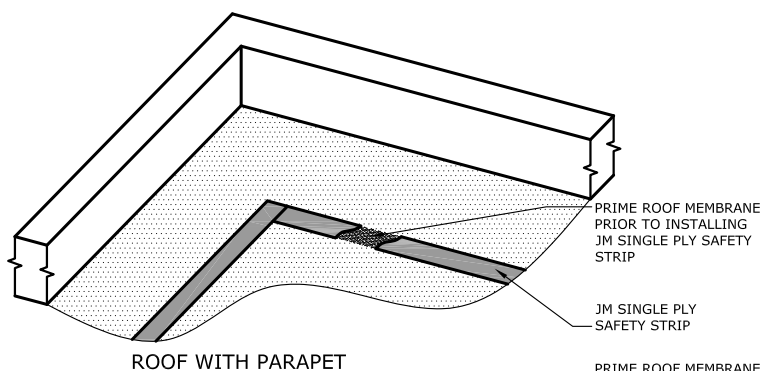

### NOTES:

1. REFER TO JOHNS MANVILLE WEBSITE ([www.jm.com](http://www.jm.com)) FOR MOST UP-TO-DATE INFORMATION.
2. PLEASE SEE SINGLE PLY FLASHING SPECIFICATIONS FOR A FULL DESCRIPTION OF INSTALLATION INSTRUCTIONS AND REQUIREMENTS WHICH ARE CONSIDERED A PART OF THIS DETAIL.
3. ANY CARPENTRY OR METAL WORK SHOULD BE DESIGNED AND CONSTRUCTED IN ACCORDANCE WITH LOCAL CODE REQUIREMENTS AND/OR PROJECT SPECIFICATIONS. THESE COMPONENTS SHOULD BE REVIEWED AND APPROVED BY A LICENSED DESIGN PROFESSIONAL.
4. PRIME MEMBRANE SURFACE PRIOR TO INSTALLING JM SINGLE PLY SAFETY STRIP.
5. MINIMIZE INSTALLING JM SINGLE PLY SAFETY STRIP OVER SEAMS AND MEMBRANE SPLICES.

## Maximum Guarantee Term: 20 Year

Johns Manville is a manufacturer of commercial roofing products and offers this general conceptual information to you as a courtesy. This complimentary assistance is not to be used or relied upon by anyone as a substitute for professional engineering design and documentation required by building code, contract, or applicable law. By accepting these comments you agree they do not constitute any representations, endorsements of, or an assumption by Johns Manville of any liability for either the adequacy of design of this building or any other material not supplied by Johns Manville.

**Note:** For the most current information on general guidelines, please refer to the System Considerations tab under Commercial Roofing Products on the JM Roofing Web site. For specifications, flashing details and general installation information please refer to the Application Tools tab.

Refer to the Safe Use Instructions and product label prior to using this product.





## JM ENRGY Anchor - TPO

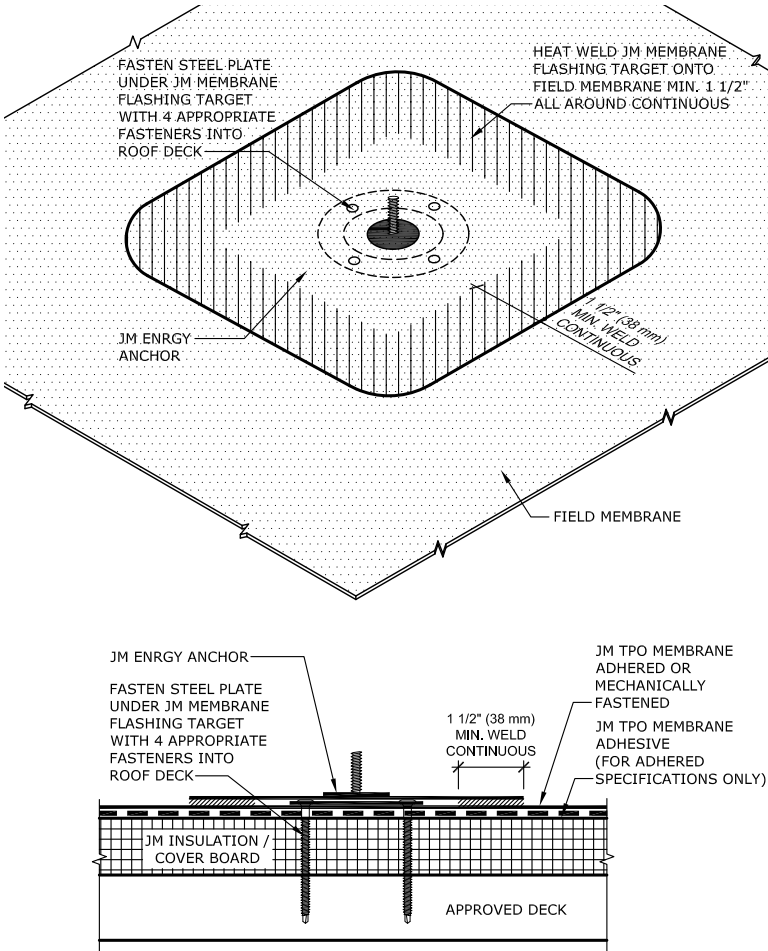

### NOTES:

1. REFER TO JOHNS MANVILLE WEBSITE ([www.jm.com](http://www.jm.com)) FOR MOST UP-TO-DATE INFORMATION.
2. PLEASE SEE SINGLE PLY FLASHING SPECIFICATIONS FOR A FULL DESCRIPTION OF INSTALLATION
3. INSTRUCTIONS AND REQUIREMENTS WHICH ARE CONSIDERED A PART OF THIS DETAIL.
4. ANY CARPENTRY OR METAL WORK SHOULD BE DESIGNED AND CONSTRUCTED IN ACCORDANCE WITH LOCAL CODE REQUIREMENTS AND/OR PROJECT SPECIFICATIONS. THESE COMPONENTS SHOULD BE REVIEWED AND APPROVED BY A LICENSED DESIGN PROFESSIONAL.
5. CLEAN MEMBRANE SURFACE PRIOR TO ENRGY ANCHOR INSTALLATION WITH JM SINGLE PLY MEMBRANE CLEANER.
6. DO NOT INSTALL ENERGY ANCHORS OVER MEMBRANE SEAMS.

Johns Manville is a manufacturer of commercial roofing products and offers this general conceptual information to you as a courtesy. This complimentary assistance is not to be used or relied upon by anyone as a substitute for professional engineering design and documentation required by building code, contract, or applicable law. By accepting these comments you agree they do not constitute any representations, endorsements of, or an assumption by Johns Manville of any liability for either the adequacy of design of this building or any other material not supplied by Johns Manville.

**Note:** For the most current information on general guidelines, please refer to the System Considerations tab under Commercial Roofing Products on the JM Roofing Web site. For specifications, flashing details and general installation information please refer to the Application Tools tab.

Refer to the Safe Use Instructions and product label prior to using this product.



## Metal Drip Edge with TPO Cover Tape

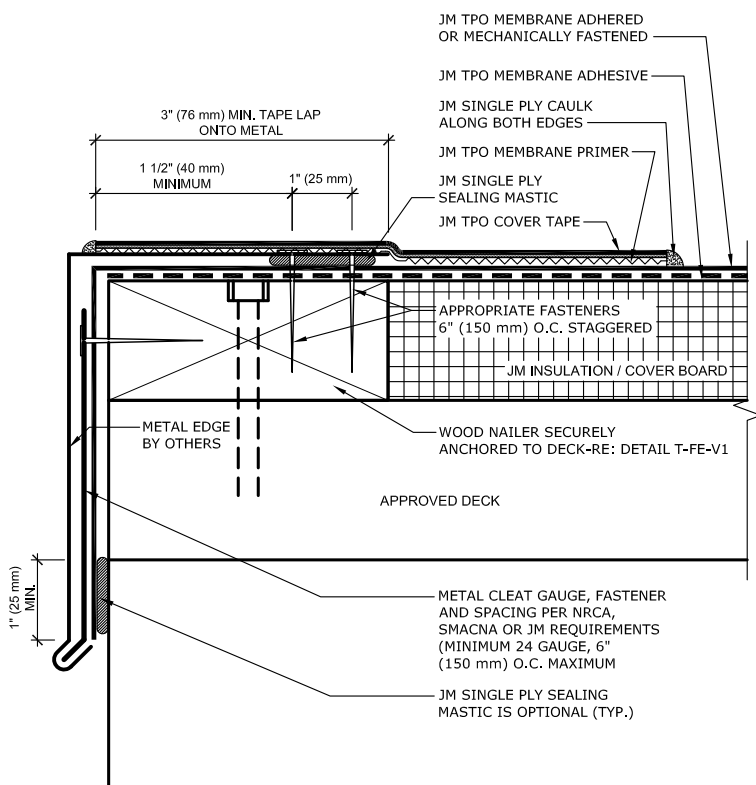

### NOTES:

1. REFER TO JOHNS MANVILLE WEBSITE ([www.jm.com](http://www.jm.com)) FOR MOST UP-TO-DATE INFORMATION.
2. PLEASE SEE SINGLE PLY FLASHING SPECIFICATIONS FOR A FULL DESCRIPTION OF INSTALLATION INSTRUCTIONS AND REQUIREMENTS WHICH ARE CONSIDERED A PART OF THIS DETAIL.
3. ANY CARPENTRY OR METAL WORK SHOULD BE DESIGNED AND CONSTRUCTED IN ACCORDANCE WITH LOCAL CODE REQUIREMENTS AND/OR PROJECT SPECIFICATIONS. THESE COMPONENTS SHOULD BE REVIEWED AND APPROVED BY A LICENSED DESIGN PROFESSIONAL.
4. JM TPO MEMBRANE PRIMER OR JM SINGLE PLY MEMBRANE PRIMER (LOW VOC) MUST BE APPLIED ON ALL SURFACES COMING INTO CONTACT WITH JM TPO PEEL & STICK PRODUCTS. ROLL MEMBRANE WITH HAND ROLLER UNDER PRESSURE AT SEAM.

## Maximum Guarantee Term: 30 Year

Johns Manville is a manufacturer of commercial roofing products and offers this general conceptual information to you as a courtesy. This complimentary assistance is not to be used or relied upon by anyone as a substitute for professional engineering design and documentation required by building code, contract, or applicable law. By accepting these comments you agree they do not constitute any representations, endorsements of, or an assumption by Johns Manville of any liability for either the adequacy of design of this building or any other material not supplied by Johns Manville.

**Note:** For the most current information on general guidelines, please refer to the System Considerations tab under Commercial Roofing Products on the JM Roofing Web site. For specifications, flashing details and general installation information please refer to the Application Tools tab.

Refer to the Safe Use Instructions and product label prior to using this product.



## Gravel Stop with JM TPO Cover Tape

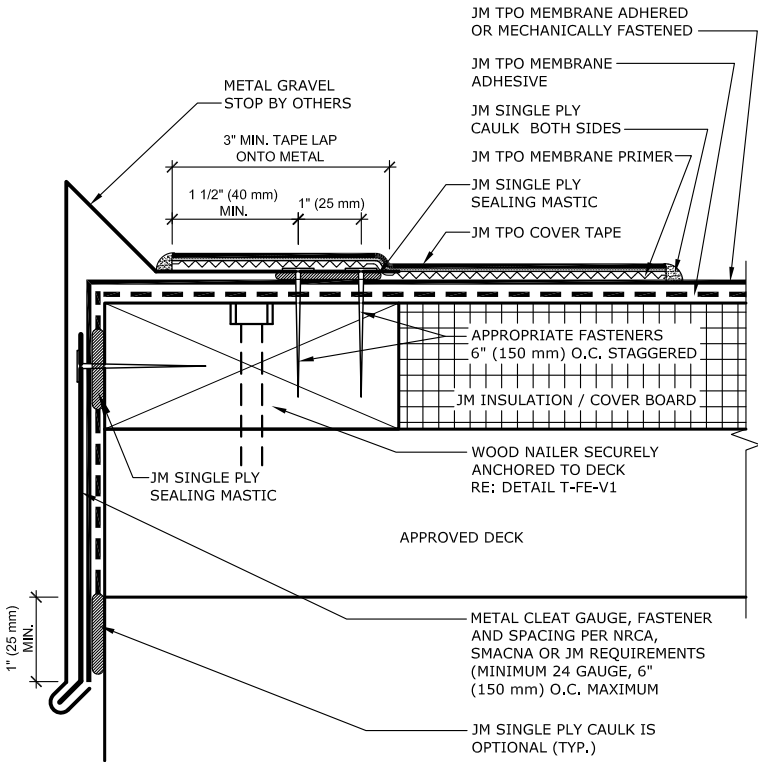

### NOTES:

1. REFER TO JOHNS MANVILLE WEBSITE ([www.jm.com](http://www.jm.com)) FOR MOST UP-TO-DATE INFORMATION.
2. PLEASE SEE SINGLE PLY FLASHING SPECIFICATIONS FOR A FULL DESCRIPTION OF INSTALLATION INSTRUCTIONS AND REQUIREMENTS WHICH ARE CONSIDERED A PART OF THIS DETAIL.
3. ANY CARPENTRY OR METAL WORK SHOULD BE DESIGNED AND CONSTRUCTED IN ACCORDANCE WITH LOCAL CODE REQUIREMENTS AND/OR PROJECT SPECIFICATIONS. THESE COMPONENTS SHOULD BE REVIEWED AND APPROVED BY A LICENSED DESIGN PROFESSIONAL.
4. JM TPO EDGE SEALANT IS REQUIRED ON ALL CUT OR NON-ENCAPSULATED EDGES OF REINFORCED MEMBRANE. THIS INCLUDES FACTORY CUT MEMBRANE (SEE DETAIL T-MS-01)
5. JM TPO MEMBRANE PRIMER OR JM SINGLE PLY MEMBRANE PRIMER (LOW VOC) MUST BE APPLIED ON ALL SURFACES COMING INTO CONTACT WITH JM TPO PEEL & STICK PRODUCTS. ROLL MEMBRANE WITH HAND ROLLER UNDER PRESSURE AT SEAM.

## Maximum Guarantee Term: 20 Year

Johns Manville is a manufacturer of commercial roofing products and offers this general conceptual information to you as a courtesy. This complimentary assistance is not to be used or relied upon by anyone as a substitute for professional engineering design and documentation required by building code, contract, or applicable law. By accepting these comments you agree they do not constitute any representations, endorsements of, or an assumption by Johns Manville of any liability for either the adequacy of design of this building or any other material not supplied by Johns Manville.

**Note:** For the most current information on general guidelines, please refer to the System Considerations tab under Commercial Roofing Products on the JM Roofing Web site. For specifications, flashing details and general installation information please refer to the Application Tools tab.

Refer to the Safe Use Instructions and product label prior to using this product.



## Gutter & Metal Edge with TPO Cover Tape

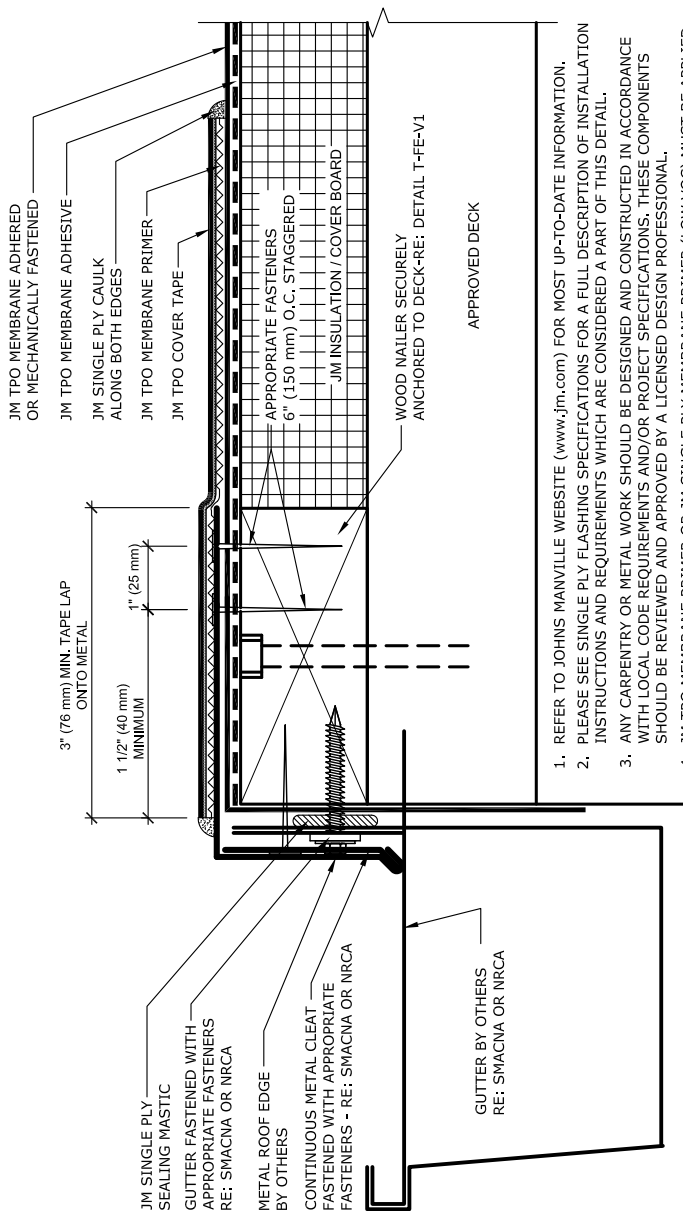

1. REFER TO JOHNS MANVILLE WEBSITE ([www.jm.com](http://www.jm.com)) FOR MOST UP-TO-DATE INFORMATION.
2. PLEASE SEE SINGLE PLY FLASHING SPECIFICATIONS FOR A FULL DESCRIPTION OF INSTALLATION INSTRUCTIONS AND REQUIREMENTS WHICH ARE CONSIDERED A PART OF THIS DETAIL.
3. ANY CARPENTRY OR METAL WORK SHOULD BE DESIGNED AND CONSTRUCTED IN ACCORDANCE WITH LOCAL CODE REQUIREMENTS AND/OR PROJECT SPECIFICATIONS. THESE COMPONENTS SHOULD BE REVIEWED AND APPROVED BY A LICENSED DESIGN PROFESSIONAL.
4. JM TPO MEMBRANE PRIMER OR JM SINGLE PLY MEMBRANE PRIMER (LOW VOC) MUST BE APPLIED ON ALL SURFACES COMING INTO CONTACT WITH JM TPO PEEL & STICK PRODUCTS. ROLL MEMBRANE WITH HAND ROLLER UNDER PRESSURE AT SEAM.

### Maximum Guarantee Term: 20 Year

Johns Manville is a manufacturer of commercial roofing products and offers this general conceptual information to you as a courtesy. This complimentary assistance is not to be used or relied upon by anyone as a substitute for professional engineering design and documentation required by building code, contract, or applicable law. By accepting these comments you agree they do not constitute any representations, endorsements of, or an assumption by Johns Manville of any liability for either the adequacy of design of this building or any other material not supplied by Johns Manville.

**Note:** For the most current information on general guidelines, please refer to the System Considerations tab under Commercial Roofing Products on the JM Roofing Web site. For specifications, flashing details and general installation information please refer to the Application Tools tab.

Refer to the Safe Use Instructions and product label prior to using this product.



## Drip Edge - TPO Coated Metal

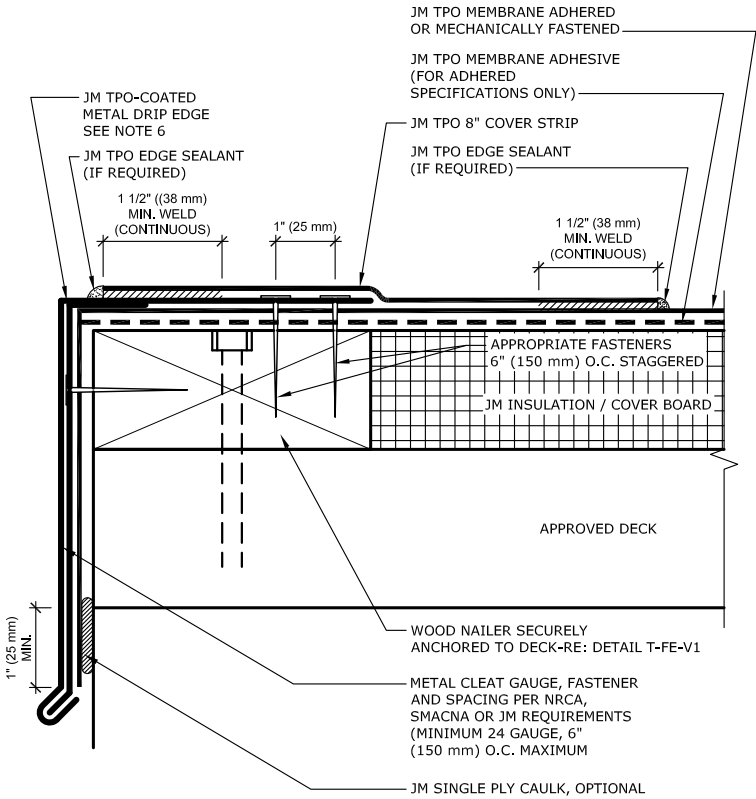

### NOTES:

1. REFER TO JOHNS MANVILLE WEBSITE ([www.jm.com](http://www.jm.com)) FOR MOST UP-TO-DATE INFORMATION.
2. PLEASE SEE SINGLE PLY FLASHING SPECIFICATIONS FOR A FULL DESCRIPTION OF INSTALLATION INSTRUCTIONS AND REQUIREMENTS WHICH ARE CONSIDERED A PART OF THIS DETAIL.
3. ANY CARPENTRY OR METAL WORK SHOULD BE DESIGNED AND CONSTRUCTED IN ACCORDANCE WITH LOCAL CODE REQUIREMENTS AND/OR PROJECT SPECIFICATIONS. THESE COMPONENTS SHOULD BE REVIEWED AND APPROVED BY A LICENSED DESIGN PROFESSIONAL.
4. JM TPO EDGE SEALANT IS REQUIRED ON ALL CUT OR NON-ENCAPSULATED EDGES OF REINFORCED MEMBRANE. THIS INCLUDES FACTORY CUT MEMBRANE (SEE DETAIL T-MS-01).
5. METAL EDGE SHOWN IS MANUFACTURED BY THE CONTRACTOR USING JM TPO COATED METAL SHEET PRODUCT.

## Maximum Guarantee Term: 30 Year

Johns Manville is a manufacturer of commercial roofing products and offers this general conceptual information to you as a courtesy. This complimentary assistance is not to be used or relied upon by anyone as a substitute for professional engineering design and documentation required by building code, contract, or applicable law. By accepting these comments you agree they do not constitute any representations, endorsements of, or an assumption by Johns Manville of any liability for either the adequacy of design of this building or any other material not supplied by Johns Manville.

**Note:** For the most current information on general guidelines, please refer to the System Considerations tab under Commercial Roofing Products on the JM Roofing Web site. For specifications, flashing details and general installation information please refer to the Application Tools tab.

Refer to the Safe Use Instructions and product label prior to using this product.



## Drip Edge - TPO Coated Metal Adhered Membrane Only

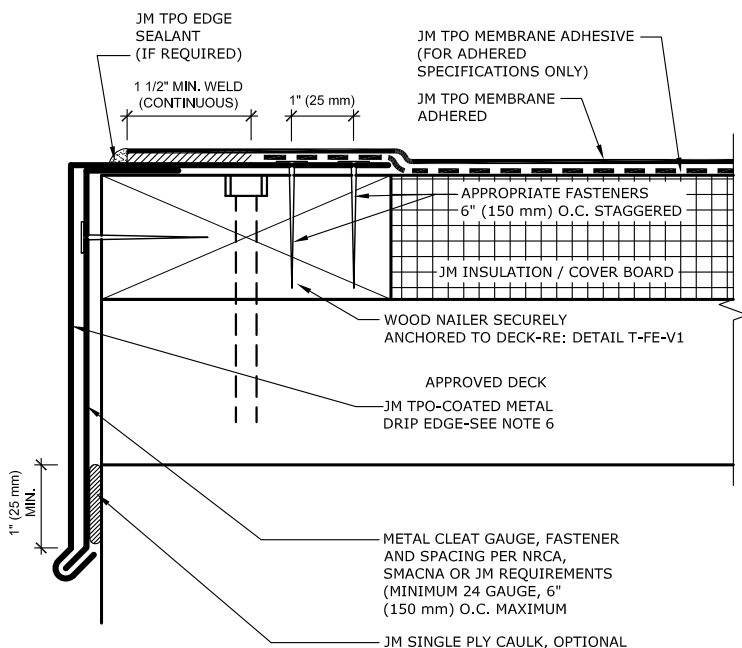

**NOTES:**

1. REFER TO JOHNS MANVILLE WEBSITE ([www.jm.com](http://www.jm.com)) FOR MOST UP-TO-DATE INFORMATION.
2. PLEASE SEE SINGLE PLY FLASHING SPECIFICATIONS FOR A FULL DESCRIPTION OF INSTALLATION INSTRUCTIONS AND REQUIREMENTS WHICH ARE CONSIDERED A PART OF THIS DETAIL.
3. ANY CARPENTRY OR METAL WORK SHOULD BE DESIGNED AND CONSTRUCTED IN ACCORDANCE WITH LOCAL CODE REQUIREMENTS AND/OR PROJECT SPECIFICATIONS. THESE COMPONENTS SHOULD BE REVIEWED AND APPROVED BY A LICENSED DESIGN PROFESSIONAL.
4. JM TPO EDGE SEALANT IS REQUIRED ON ALL CUT OR NON-ENCAPSULATED EDGES OF REINFORCED MEMBRANE. THIS INCLUDES FACTORY CUT MEMBRANE (SEE DETAIL T-MS-01).
5. THIS DETAIL IS ACCEPTABLE FOR ADHERED MEMBRANE SYSTEMS ONLY
6. METAL EDGE SHOWN IS MANUFACTURED BY THE CONTRACTOR USING JM TPO COATED METAL SHEET PRODUCT.
7. THIS DETAIL IS NOT COMPATIBLE OR ELIGIBLE FOR GUARANTEE WITH JM SELF ADHERED TPO MEMBRANE.

### Maximum Guarantee Term: 20 Year

Johns Manville is a manufacturer of commercial roofing products and offers this general conceptual information to you as a courtesy. This complimentary assistance is not to be used or relied upon by anyone as a substitute for professional engineering design and documentation required by building code, contract, or applicable law. By accepting these comments you agree they do not constitute any representations, endorsements of, or an assumption by Johns Manville of any liability for either the adequacy of design of this building or any other material not supplied by Johns Manville.

**Note:** For the most current information on general guidelines, please refer to the System Considerations tab under Commercial Roofing Products on the JM Roofing Web site. For specifications, flashing details and general installation information please refer to the Application Tools tab.

Refer to the Safe Use Instructions and product label prior to using this product.



## Gravel Stop - TPO Coated Metal

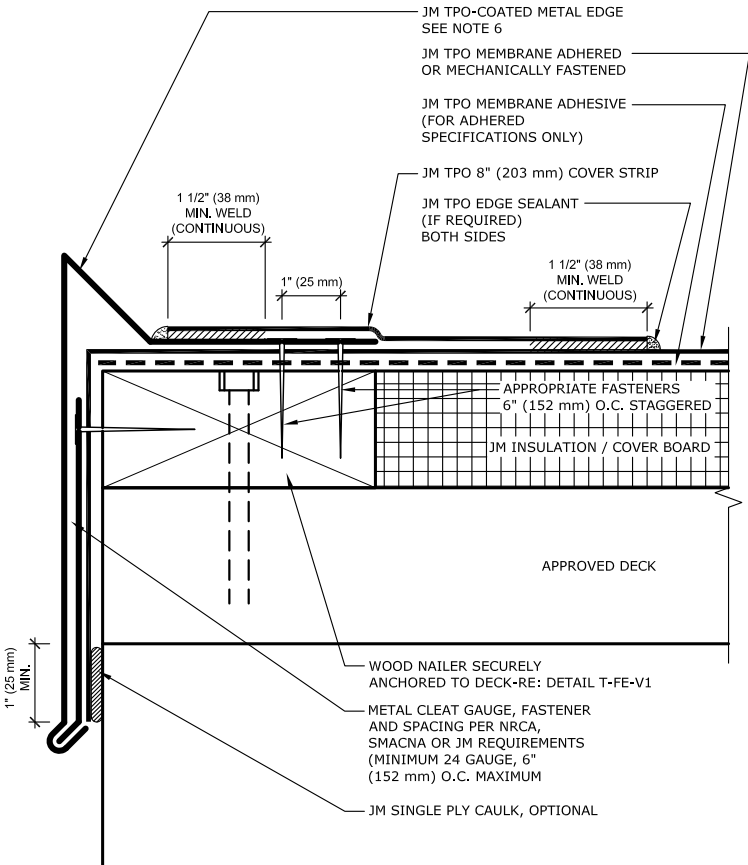

### NOTES:

1. REFER TO JOHNS MANVILLE WEBSITE ([www.jm.com](http://www.jm.com)) FOR MOST UP-TO-DATE INFORMATION.
2. PLEASE SEE SINGLE PLY FLASHING SPECIFICATIONS FOR A FULL DESCRIPTION OF INSTALLATION INSTRUCTIONS AND REQUIREMENTS WHICH ARE CONSIDERED A PART OF THIS DETAIL.
3. ANY CARPENTRY OR METAL WORK SHOULD BE DESIGNED AND CONSTRUCTED IN ACCORDANCE WITH LOCAL CODE REQUIREMENTS AND/OR PROJECT SPECIFICATIONS. THESE COMPONENTS SHOULD BE REVIEWED AND APPROVED BY A LICENSED DESIGN PROFESSIONAL.
4. JM TPO EDGE SEALANT IS REQUIRED ON ALL CUT OR NON-ENCAPSULATED EDGES OF REINFORCED MEMBRANE. THIS INCLUDES FACTORY CUT MEMBRANE (SEE DETAIL T-MS-01).
5. THIS DETAIL IS ACCEPTABLE FOR ADHERED MEMBRANE SYSTEMS ONLY
6. METAL EDGE SHOWN IS MANUFACTURED BY THE CONTRACTOR USING JM TPO COATED METAL SHEET PRODUCT.

## Maximum Guarantee Term: 30 Year

Johns Manville is a manufacturer of commercial roofing products and offers this general conceptual information to you as a courtesy. This complimentary assistance is not to be used or relied upon by anyone as a substitute for professional engineering design and documentation required by building code, contract, or applicable law. By accepting these comments you agree they do not constitute any representations, endorsements of, or an assumption by Johns Manville of any liability for either the adequacy of design of this building or any other material not supplied by Johns Manville.

**Note:** For the most current information on general guidelines, please refer to the System Considerations tab under Commercial Roofing Products on the JM Roofing Web site. For specifications, flashing details and general installation information please refer to the Application Tools tab.

Refer to the Safe Use Instructions and product label prior to using this product.



## Gravel Stop - TPO Coated Metal Adhered Membrane Only

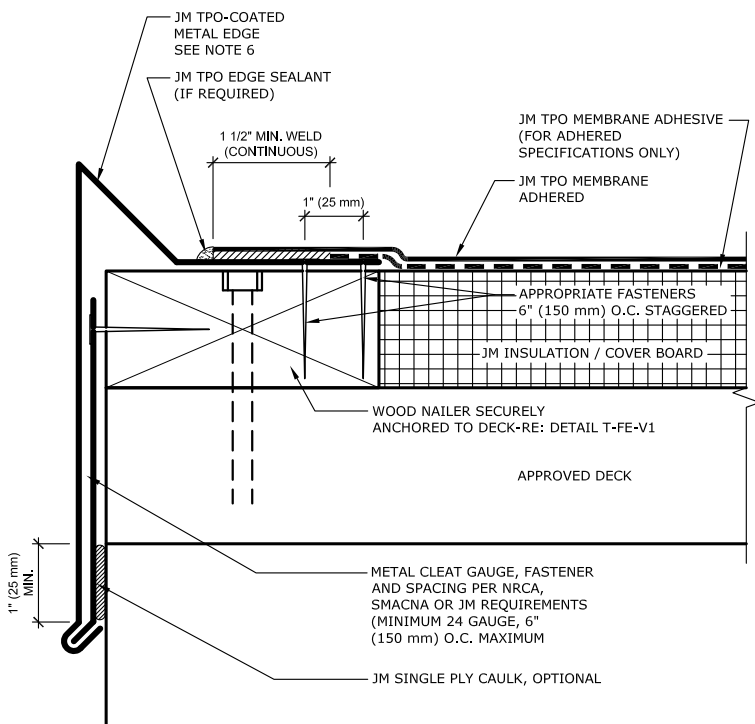

### NOTES:

1. REFER TO JOHNS MANVILLE WEBSITE ([www.jm.com](http://www.jm.com)) FOR MOST UP-TO-DATE INFORMATION.
2. PLEASE SEE SINGLE PLY FLASHING SPECIFICATIONS FOR A FULL DESCRIPTION OF INSTALLATION INSTRUCTIONS AND REQUIREMENTS WHICH ARE CONSIDERED A PART OF THIS DETAIL.
3. ANY CARPENTRY OR METAL WORK SHOULD BE DESIGNED AND CONSTRUCTED IN ACCORDANCE WITH LOCAL CODE REQUIREMENTS AND/OR PROJECT SPECIFICATIONS. THESE COMPONENTS SHOULD BE REVIEWED AND APPROVED BY A LICENSED DESIGN PROFESSIONAL.
4. JM TPO EDGE SEALANT IS REQUIRED ON ALL CUT OR NON-ENCAPSULATED EDGES OF REINFORCED MEMBRANE. THIS INCLUDES FACTORY CUT MEMBRANE (SEE DETAIL T-MS-01).
5. THIS DETAIL IS ACCEPTABLE FOR ADHERED MEMBRANE SYSTEMS ONLY
6. METAL EDGE SHOWN IS MANUFACTURED BY THE CONTRACTOR USING JM TPO COATED METAL SHEET PRODUCT.
7. THIS DETAIL IS NOT COMPATIBLE OR ELIGIBLE FOR GUARANTEE WITH JM SELF ADHERED TPO MEMBRANE.

## Maximum Guarantee Term: 20 Year

Johns Manville is a manufacturer of commercial roofing products and offers this general conceptual information to you as a courtesy. This complimentary assistance is not to be used or relied upon by anyone as a substitute for professional engineering design and documentation required by building code, contract, or applicable law. By accepting these comments you agree they do not constitute any representations, endorsements of, or an assumption by Johns Manville of any liability for either the adequacy of design of this building or any other material not supplied by Johns Manville.

**Note:** For the most current information on general guidelines, please refer to the System Considerations tab under Commercial Roofing Products on the JM Roofing Web site. For specifications, flashing details and general installation information please refer to the Application Tools tab.

Refer to the Safe Use Instructions and product label prior to using this product.





## Gutter & TPO Coated Metal Edge

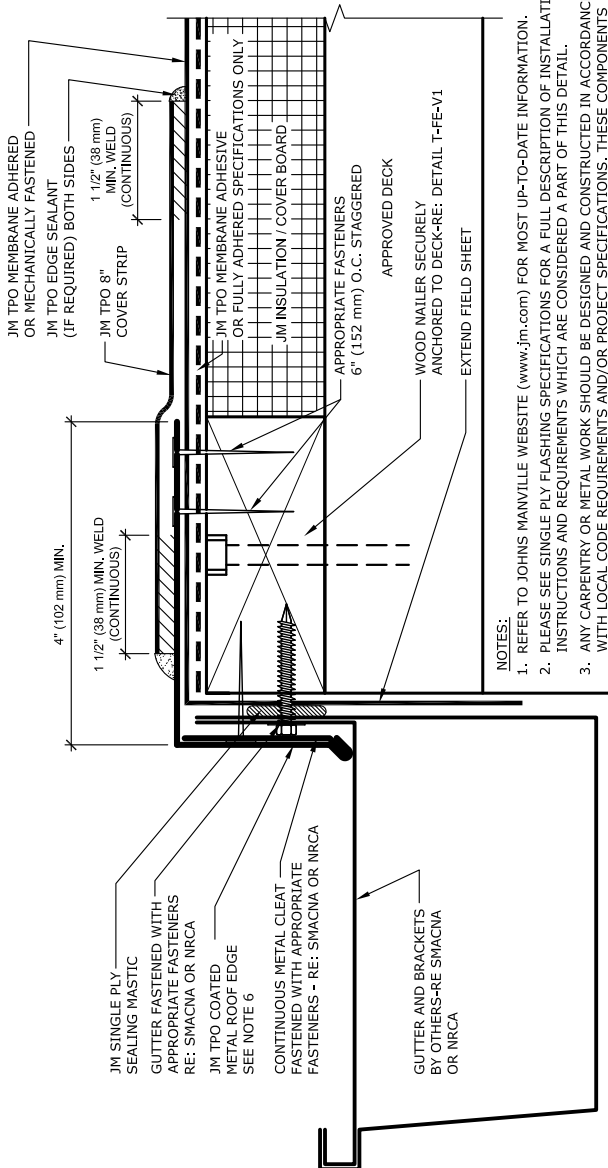

**NOTES:**

1. REFER TO JOHNS MANVILLE WEBSITE ([www.jm.com](http://www.jm.com)) FOR MOST UP-TO-DATE INFORMATION.
2. PLEASE SEE SINGLE PLY FLASHING SPECIFICATIONS FOR A FULL DESCRIPTION OF INSTALLATION INSTRUCTIONS AND REQUIREMENTS WHICH ARE CONSIDERED A PART OF THIS DETAIL.
3. ANY CARPENTRY OR METAL WORK SHOULD BE DESIGNED AND CONSTRUCTED IN ACCORDANCE WITH LOCAL CODE REQUIREMENTS AND/OR PROJECT SPECIFICATIONS. THESE COMPONENTS SHOULD BE REVIEWED AND APPROVED BY A LICENSED DESIGN PROFESSIONAL.
4. JM TPO EDGE SEALANT IS REQUIRED ON ALL CUT OR NON-ENCAPSULATED EDGES OF REINFORCED MEMBRANE. THIS INCLUDES FACTORY CUT MEMBRANE (SEE DETAIL T-MS-01).
5. METAL EDGE SHOWN IS MANUFACTURED BY THE CONTRACTOR USING JM TPO COATED METAL SHEET PRODUCT.

### Maximum Guarantee Term: 30 Year

Johns Manville is a manufacturer of commercial roofing products and offers this general conceptual information to you as a courtesy. This complimentary assistance is not to be used or relied upon by anyone as a substitute for professional engineering design and documentation required by building code, contract, or applicable law. By accepting these comments you agree they do not constitute any representations, endorsements of, or an assumption by Johns Manville of any liability for either the adequacy of design of this building or any other material not supplied by Johns Manville.

**Note:** For the most current information on general guidelines, please refer to the System Considerations tab under Commercial Roofing Products on the JM Roofing Web site. For specifications, flashing details and general installation information please refer to the Application Tools tab.

Refer to the Safe Use Instructions and product label prior to using this product.



## Butt Joint at Edge - TPO Coated Metal

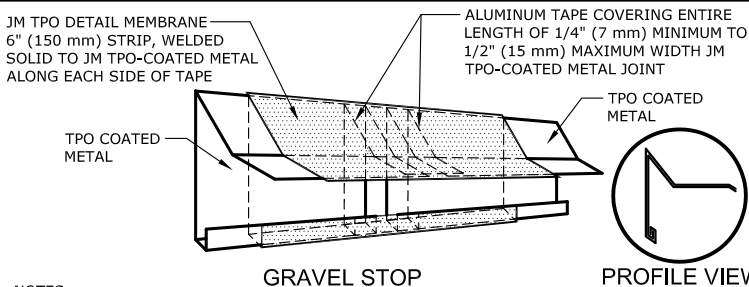
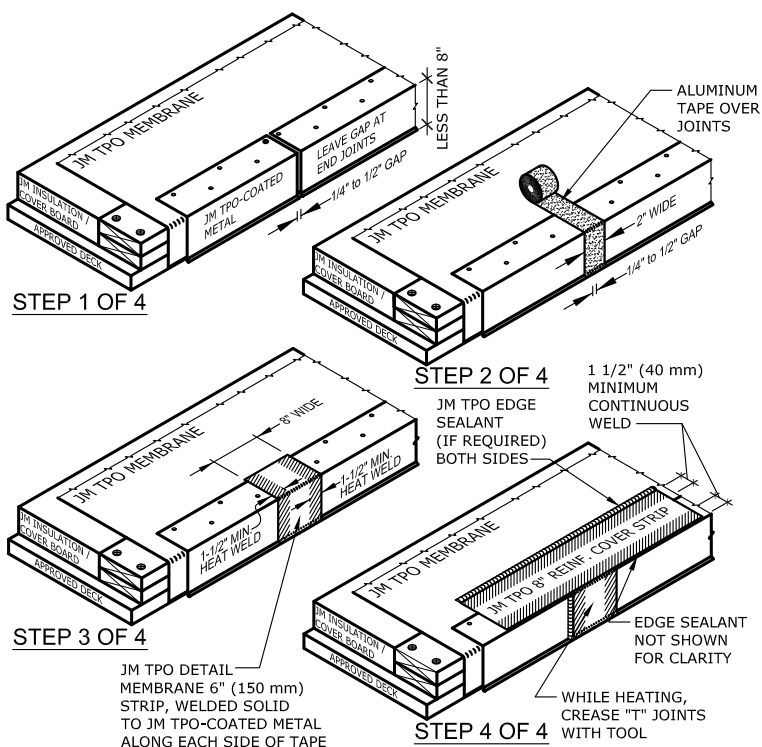

### NOTES:

1. REFER TO JOHNS MANVILLE WEBSITE ([www.jm.com](http://www.jm.com)) FOR MOST UP-TO-DATE INFORMATION.
2. PLEASE SEE SINGLE PLY FLASHING SPECIFICATIONS FOR A FULL DESCRIPTION OF INSTALLATION INSTRUCTIONS AND REQUIREMENTS WHICH ARE CONSIDERED A PART OF THIS DETAIL.
3. ANY CARPENTRY OR METAL WORK SHOULD BE DESIGNED AND CONSTRUCTED IN ACCORDANCE WITH LOCAL CODE REQUIREMENTS AND/OR PROJECT SPECIFICATIONS, THESE COMPONENTS SHOULD BE REVIEWED AND APPROVED BY A LICENSED DESIGN PROFESSIONAL.
4. JM TPO EDGE SEALANT IS REQUIRED ON ALL CUT OR NON-ENCAPSULATED EDGES OF REINFORCED MEMBRANE. THIS INCLUDES FACTORY CUT MEMBRANE (SEE DETAIL T-MS-01).

## Maximum Guarantee Term: 30 Year

Johns Manville is a manufacturer of commercial roofing products and offers this general conceptual information to you as a courtesy. This complimentary assistance is not to be used or relied upon by anyone as a substitute for professional engineering design and documentation required by building code, contract, or applicable law. By accepting these comments you agree they do not constitute any representations, endorsements of, or an assumption by Johns Manville of any liability for either the adequacy of design of this building or any other material not supplied by Johns Manville.

**Note:** For the most current information on general guidelines, please refer to the System Considerations tab under Commercial Roofing Products on the JM Roofing Web site. For specifications, flashing details and general installation information please refer to the Application Tools tab.

Refer to the Safe Use Instructions and product label prior to using this product.



## JM Presto-Tite Drip Edge

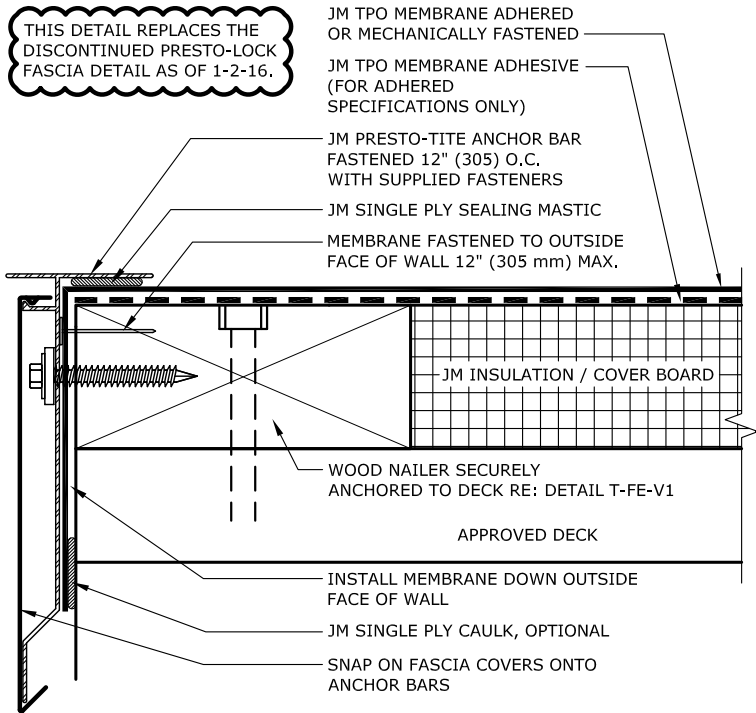

### NOTES:

1. REFER TO JOHNS MANVILLE WEBSITE ([www.jm.com](http://www.jm.com)) FOR MOST UP-TO-DATE INFORMATION.
2. PLEASE SEE SINGLE PLY FLASHING SPECIFICATIONS FOR A FULL DESCRIPTION OF INSTALLATION INSTRUCTIONS AND REQUIREMENTS WHICH ARE CONSIDERED A PART OF THIS DETAIL.
3. ANY CARPENTRY OR METAL WORK SHOULD BE DESIGNED AND CONSTRUCTED IN ACCORDANCE WITH LOCAL CODE REQUIREMENTS AND/OR PROJECT SPECIFICATIONS. THESE COMPONENTS SHOULD BE REVIEWED AND APPROVED BY A LICENSED DESIGN PROFESSIONAL.

## Maximum Guarantee Term: 30 Year

Johns Manville is a manufacturer of commercial roofing products and offers this general conceptual information to you as a courtesy. This complimentary assistance is not to be used or relied upon by anyone as a substitute for professional engineering design and documentation required by building code, contract, or applicable law. By accepting these comments you agree they do not constitute any representations, endorsements of, or an assumption by Johns Manville of any liability for either the adequacy of design of this building or any other material not supplied by Johns Manville.

**Note:** For the most current information on general guidelines, please refer to the System Considerations tab under Commercial Roofing Products on the JM Roofing Web site. For specifications, flashing details and general installation information please refer to the Application Tools tab.

Refer to the Safe Use Instructions and product label prior to using this product.



## JM Presto-Tite Fascia System for Single Ply Systems

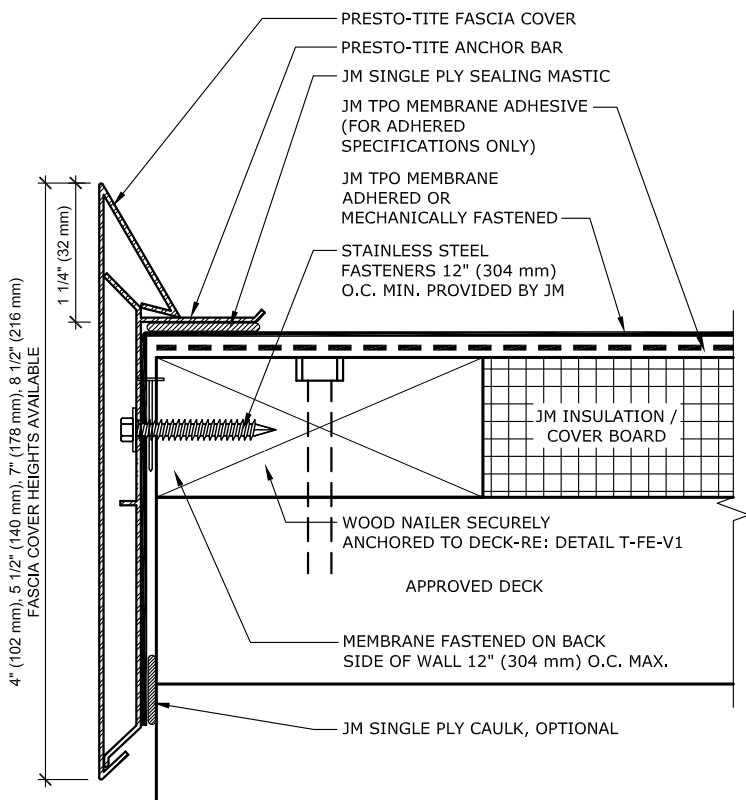

**NOTES:**

1. REFER TO JOHNS MANVILLE WEBSITE ([www.jm.com](http://www.jm.com)) FOR MOST UP-TO-DATE INFORMATION.
2. PLEASE SEE SINGLE PLY FLASHING SPECIFICATIONS FOR A FULL DESCRIPTION OF INSTALLATION INSTRUCTIONS AND REQUIREMENTS WHICH ARE CONSIDERED A PART OF THIS DETAIL.
3. ANY CARPENTRY OR METAL WORK SHOULD BE DESIGNED AND CONSTRUCTED IN ACCORDANCE WITH LOCAL CODE REQUIREMENTS AND/OR PROJECT SPECIFICATIONS. THESE COMPONENTS SHOULD BE REVIEWED AND APPROVED BY A LICENSED DESIGN PROFESSIONAL.
4. JM TPO EDGE SEALANT IS REQUIRED ON ALL CUT OR NON-ENCAPSULATED EDGES OF REINFORCED MEMBRANE. THIS INCLUDES FACTORY CUT MEMBRANE (SEE DETAIL T-MS-01)

### Maximum Guarantee Term: 30 Year

Johns Manville is a manufacturer of commercial roofing products and offers this general conceptual information to you as a courtesy. This complimentary assistance is not to be used or relied upon by anyone as a substitute for professional engineering design and documentation required by building code, contract, or applicable law. By accepting these comments you agree they do not constitute any representations, endorsements of, or an assumption by Johns Manville of any liability for either the adequacy of design of this building or any other material not supplied by Johns Manville.

**Note:** For the most current information on general guidelines, please refer to the System Considerations tab under Commercial Roofing Products on the JM Roofing Web site. For specifications, flashing details and general installation information please refer to the Application Tools tab.

Refer to the Safe Use Instructions and product label prior to using this product.



## JM Presto-Tite Edge One

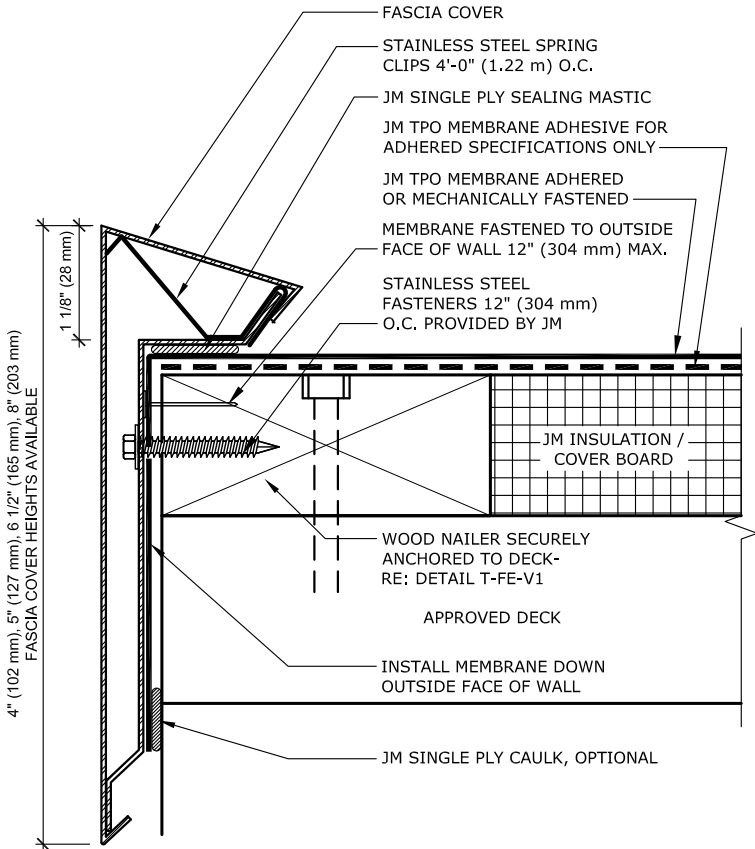

### NOTES:

1. REFER TO JOHNS MANVILLE WEBSITE ([www.jm.com](http://www.jm.com)) FOR MOST UP-TO-DATE INFORMATION.
2. PLEASE SEE SINGLE PLY FLASHING SPECIFICATIONS FOR A FULL DESCRIPTION OF INSTALLATION INSTRUCTIONS AND REQUIREMENTS WHICH ARE CONSIDERED A PART OF THIS DETAIL.
3. ANY CARPENTRY OR METAL WORK SHOULD BE DESIGNED AND CONSTRUCTED IN ACCORDANCE WITH LOCAL CODE REQUIREMENTS AND/OR PROJECT SPECIFICATIONS. THESE COMPONENTS SHOULD BE REVIEWED AND APPROVED BY A LICENSED DESIGN PROFESSIONAL.
4. JM TPO EDGE SEALANT IS REQUIRED ON ALL CUT OR NON-ENCAPSULATED EDGES OF REINFORCED MEMBRANE. THIS INCLUDES FACTORY CUT MEMBRANE (SEE DETAIL T-MS-01)

## Maximum Guarantee Term: 30 Year

Johns Manville is a manufacturer of commercial roofing products and offers this general conceptual information to you as a courtesy. This complimentary assistance is not to be used or relied upon by anyone as a substitute for professional engineering design and documentation required by building code, contract, or applicable law. By accepting these comments you agree they do not constitute any representations, endorsements of, or an assumption by Johns Manville of any liability for either the adequacy of design of this building or any other material not supplied by Johns Manville.

**Note:** For the most current information on general guidelines, please refer to the System Considerations tab under Commercial Roofing Products on the JM Roofing Web site. For specifications, flashing details and general installation information please refer to the Application Tools tab.

Refer to the Safe Use Instructions and product label prior to using this product.



## JM Perma-Tite System 200 Fascia

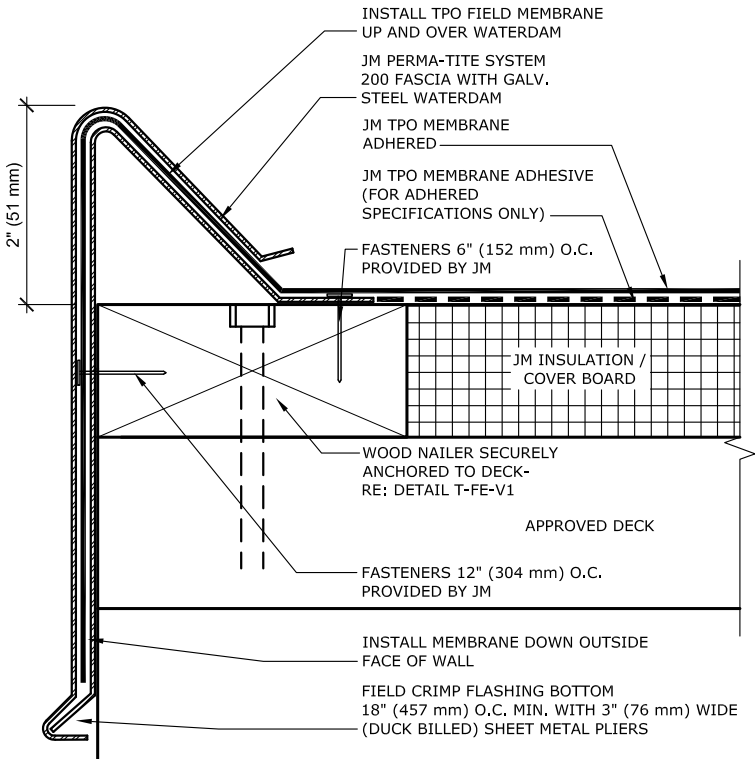

**NOTES:**

1. REFER TO JOHNS MANVILLE WEBSITE ([www.jm.com](http://www.jm.com)) FOR MOST UP-TO-DATE INFORMATION.
2. PLEASE SEE SINGLE PLY FLASHING SPECIFICATIONS FOR A FULL DESCRIPTION OF INSTALLATION INSTRUCTIONS AND REQUIREMENTS WHICH ARE CONSIDERED A PART OF THIS DETAIL.
3. ANY CARPENTRY OR METAL WORK SHOULD BE DESIGNED AND CONSTRUCTED IN ACCORDANCE WITH LOCAL CODE REQUIREMENTS AND/OR PROJECT SPECIFICATIONS. THESE COMPONENTS SHOULD BE REVIEWED AND APPROVED BY A LICENSED DESIGN PROFESSIONAL.
4. JM TPO EDGE SEALANT IS REQUIRED ON ALL CUT OR NON-ENCAPSULATED EDGES OF REINFORCED MEMBRANE. THIS INCLUDES FACTORY CUT MEMBRANE (SEE DETAIL T-MS-01)
5. THIS DETAIL IS NOT COMPATIBLE OR ELIGIBLE FOR GUARANTEE WITH JM SELF ADHERED TPO MEMBRANE.

### Maximum Guarantee Term: 20 Year

Johns Manville is a manufacturer of commercial roofing products and offers this general conceptual information to you as a courtesy. This complimentary assistance is not to be used or relied upon by anyone as a substitute for professional engineering design and documentation required by building code, contract, or applicable law. By accepting these comments you agree they do not constitute any representations, endorsements of, or an assumption by Johns Manville of any liability for either the adequacy of design of this building or any other material not supplied by Johns Manville.

**Note:** For the most current information on general guidelines, please refer to the System Considerations tab under Commercial Roofing Products on the JM Roofing Web site. For specifications, flashing details and general installation information please refer to the Application Tools tab.

Refer to the Safe Use Instructions and product label prior to using this product.



## JM Metal Drip Edge with JM TPO Cover Tape

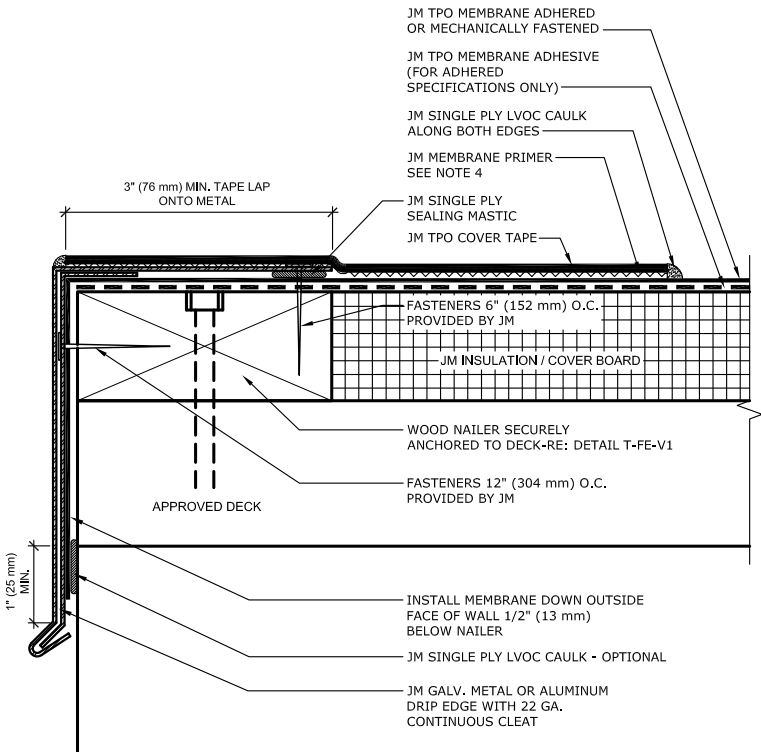

**NOTES:**

1. REFER TO JOHNS MANVILLE WEBSITE ([www.jm.com](http://www.jm.com)) FOR MOST UP-TO-DATE INFORMATION.
2. PLEASE SEE SINGLE PLY FLASHING SPECIFICATIONS FOR A FULL DESCRIPTION OF INSTALLATION INSTRUCTIONS AND REQUIREMENTS WHICH ARE CONSIDERED A PART OF THIS DETAIL.
3. ANY CARPENTRY OR METAL WORK SHOULD BE DESIGNED AND CONSTRUCTED IN ACCORDANCE WITH LOCAL CODE REQUIREMENTS AND/OR PROJECT SPECIFICATIONS. THESE COMPONENTS SHOULD BE REVIEWED AND APPROVED BY A LICENSED DESIGN PROFESSIONAL.
4. JM TPO MEMBRANE PRIMER OR JM SINGLE PLY MEMBRANE PRIMER (LOW VOC) MUST BE APPLIED ON ALL SURFACES COMING INTO CONTACT WITH TPO PEEL & STICK PRODUCTS. ROLL MEMBRANE WITH HAND ROLLER UNDER PRESSURE AT SEAM.

### Maximum Guarantee Term: 20 Year

Johns Manville is a manufacturer of commercial roofing products and offers this general conceptual information to you as a courtesy. This complimentary assistance is not to be used or relied upon by anyone as a substitute for professional engineering design and documentation required by building code, contract, or applicable law. By accepting these comments you agree they do not constitute any representations, endorsements of, or an assumption by Johns Manville of any liability for either the adequacy of design of this building or any other material not supplied by Johns Manville.

**Note:** For the most current information on general guidelines, please refer to the System Considerations tab under Commercial Roofing Products on the JM Roofing Web site. For specifications, flashing details and general installation information please refer to the Application Tools tab.

Refer to the Safe Use Instructions and product label prior to using this product.



## JM Gravel Stop with JM TPO Cover Tape

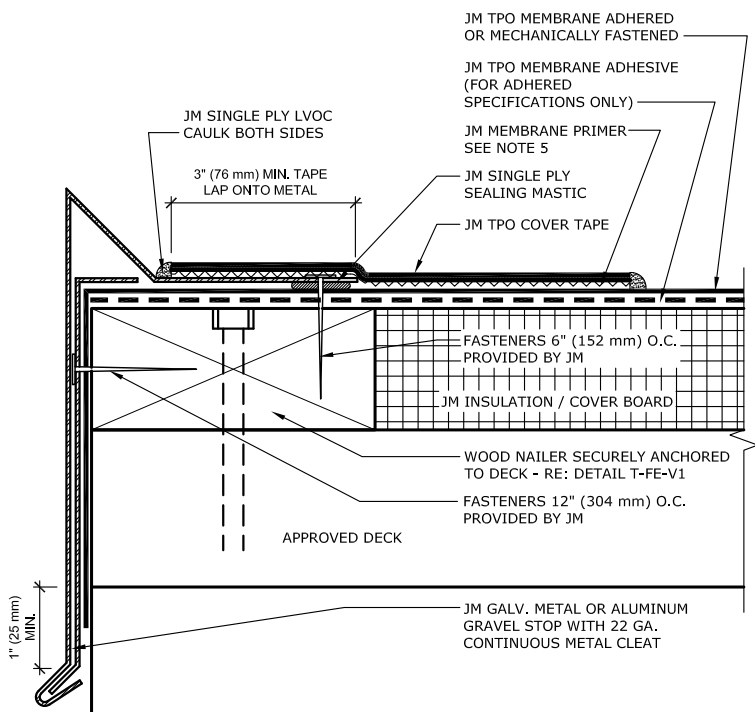

### NOTES:

1. REFER TO JOHNS MANVILLE WEBSITE ([www.jm.com](http://www.jm.com)) FOR MOST UP-TO-DATE INFORMATION.
2. PLEASE SEE SINGLE PLY FLASHING SPECIFICATIONS FOR A FULL DESCRIPTION OF INSTALLATION INSTRUCTIONS AND REQUIREMENTS WHICH ARE CONSIDERED A PART OF THIS DETAIL.
3. ANY CARPENTRY OR METAL WORK SHOULD BE DESIGNED AND CONSTRUCTED IN ACCORDANCE WITH LOCAL CODE REQUIREMENTS AND/OR PROJECT SPECIFICATIONS. THESE COMPONENTS SHOULD BE REVIEWED AND APPROVED BY A LICENSED DESIGN PROFESSIONAL.
4. JM TPO EDGE SEALANT IS REQUIRED ON ALL CUT OR NON-ENCAPSULATED EDGES OF REINFORCED MEMBRANE. THIS INCLUDES FACTORY CUT MEMBRANE (SEE DETAIL T-MS-01)
5. JM TPO MEMBRANE PRIMER OR JM SINGLE PLY MEMBRANE PRIMER (LOW VOC) MUST BE APPLIED ON ALL SURFACES COMING INTO CONTACT WITH TPO PEEL & STICK PRODUCTS. ROLL MEMBRANE WITH HAND ROLLER UNDER PRESSURE AT SEAM.

## Maximum Guarantee Term: 20 Year

Johns Manville is a manufacturer of commercial roofing products and offers this general conceptual information to you as a courtesy. This complimentary assistance is not to be used or relied upon by anyone as a substitute for professional engineering design and documentation required by building code, contract, or applicable law. By accepting these comments you agree they do not constitute any representations, endorsements of, or an assumption by Johns Manville of any liability for either the adequacy of design of this building or any other material not supplied by Johns Manville.

**Note:** For the most current information on general guidelines, please refer to the System Considerations tab under Commercial Roofing Products on the JM Roofing Web site. For specifications, flashing details and general installation information please refer to the Application Tools tab.

Refer to the Safe Use Instructions and product label prior to using this product.





## JM TPO Presto Weld Drip Edge

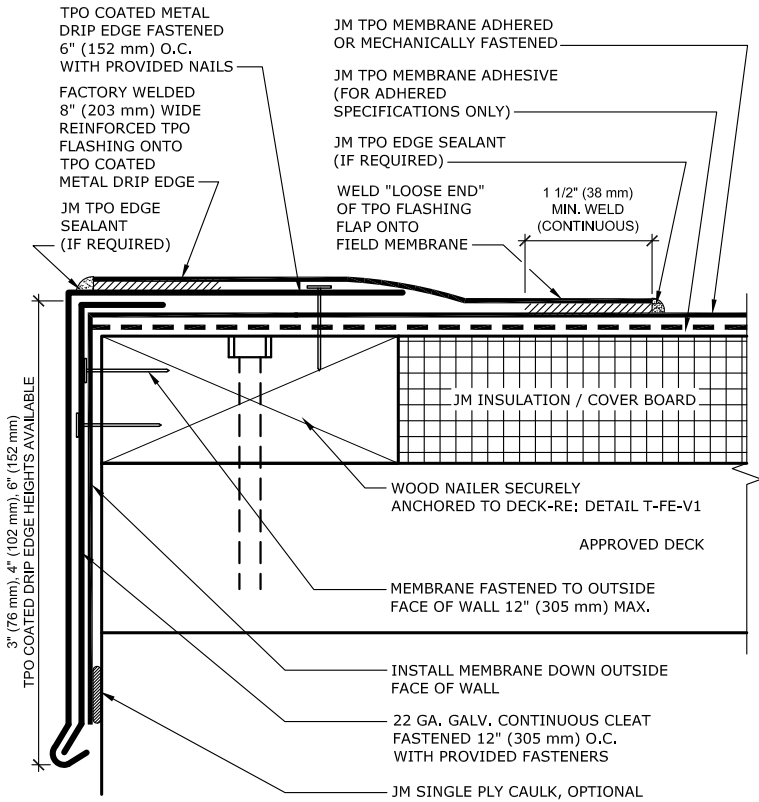

### NOTES:

1. REFER TO JOHNS MANVILLE WEBSITE ([www.jm.com](http://www.jm.com)) FOR MOST UP-TO-DATE INFORMATION.
2. PLEASE SEE SINGLE PLY FLASHING SPECIFICATIONS FOR A FULL DESCRIPTION OF INSTALLATION INSTRUCTIONS AND REQUIREMENTS WHICH ARE CONSIDERED A PART OF THIS DETAIL.
3. ANY CARPENTRY OR METAL WORK SHOULD BE DESIGNED AND CONSTRUCTED IN ACCORDANCE WITH LOCAL CODE REQUIREMENTS AND/OR PROJECT SPECIFICATIONS. THESE COMPONENTS SHOULD BE REVIEWED AND APPROVED BY A LICENSED DESIGN PROFESSIONAL.
4. JM TPO EDGE SEALANT IS REQUIRED ON ALL CUT OR NON-ENCAPSULATED EDGES OF REINFORCED MEMBRANE. THIS INCLUDES FACTORY CUT MEMBRANE (SEE DETAIL T-MS-01)

## Maximum Guarantee Term: 20 Year

Johns Manville is a manufacturer of commercial roofing products and offers this general conceptual information to you as a courtesy. This complimentary assistance is not to be used or relied upon by anyone as a substitute for professional engineering design and documentation required by building code, contract, or applicable law. By accepting these comments you agree they do not constitute any representations, endorsements of, or an assumption by Johns Manville of any liability for either the adequacy of design of this building or any other material not supplied by Johns Manville.

**Note:** For the most current information on general guidelines, please refer to the System Considerations tab under Commercial Roofing Products on the JM Roofing Web site. For specifications, flashing details and general installation information please refer to the Application Tools tab.

Refer to the Safe Use Instructions and product label prior to using this product.



## Wood Nailer Attachment

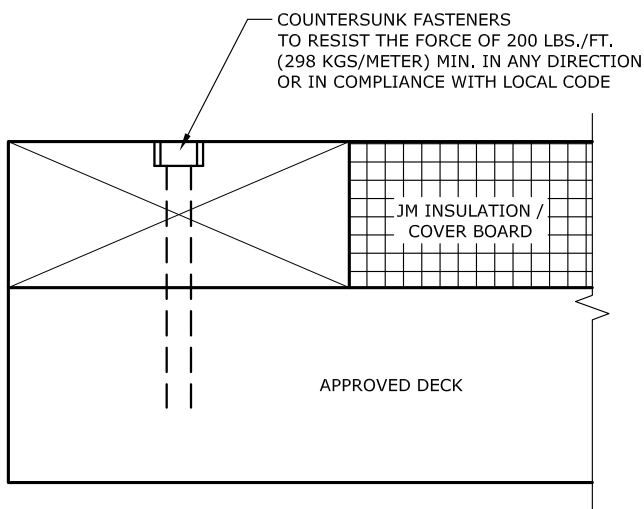

**NOTES:**

1. REFER TO JOHNS MANVILLE WEBSITE ([www.jm.com](http://www.jm.com)) FOR MOST UP-TO-DATE INFORMATION.
2. PLEASE SEE SINGLE PLY FLASHING SPECIFICATIONS FOR A FULL DESCRIPTION OF INSTALLATION INSTRUCTIONS AND REQUIREMENTS WHICH ARE CONSIDERED A PART OF THIS DETAIL.
3. ANY CARPENTRY OR METAL WORK SHOULD BE DESIGNED AND CONSTRUCTED IN ACCORDANCE WITH LOCAL CODE REQUIREMENTS AND/OR PROJECT SPECIFICATIONS. THESE COMPONENTS SHOULD BE REVIEWED AND APPROVED BY A LICENSED DESIGN PROFESSIONAL.

Johns Manville is a manufacturer of commercial roofing products and offers this general conceptual information to you as a courtesy. This complimentary assistance is not to be used or relied upon by anyone as a substitute for professional engineering design and documentation required by building code, contract, or applicable law. By accepting these comments you agree they do not constitute any representations, endorsements of, or an assumption by Johns Manville of any liability for either the adequacy of design of this building or any other material not supplied by Johns Manville.

**Note:** For the most current information on general guidelines, please refer to the System Considerations tab under Commercial Roofing Products on the JM Roofing Web site. For specifications, flashing details and general installation information please refer to the Application Tools tab.

Refer to the Safe Use Instructions and product label prior to using this product.



## Gutter & Termination Bar

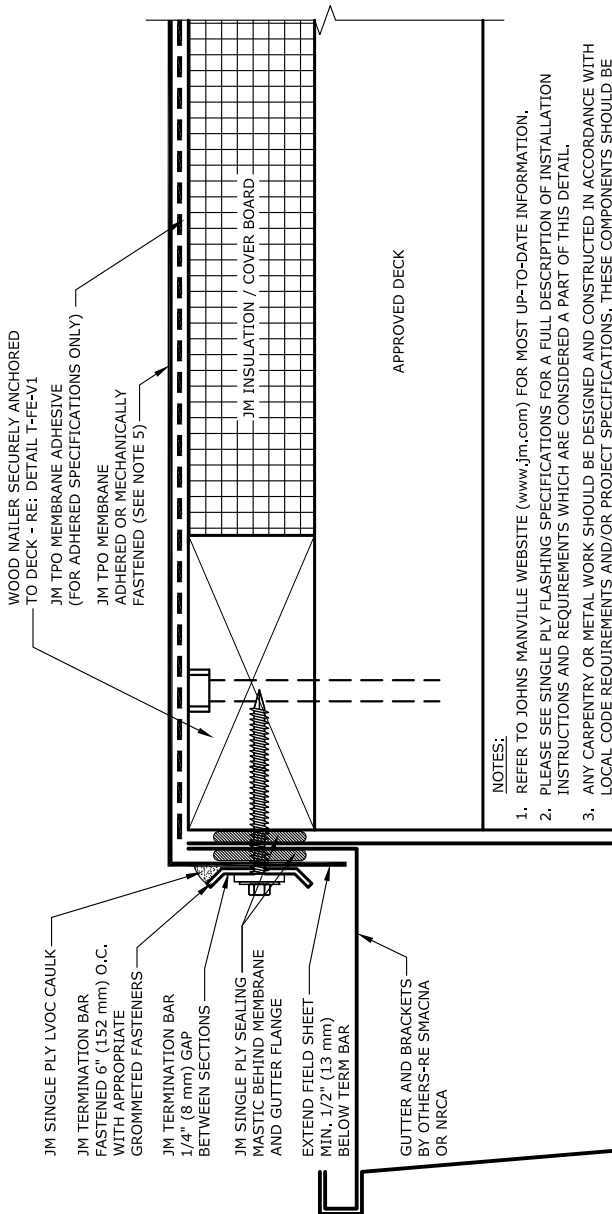

**NOTES:**

1. REFER TO JOHNS MANVILLE WEBSITE ([www.jm.com](http://www.jm.com)) FOR MOST UP-TO-DATE INFORMATION.
2. PLEASE SEE SINGLE PLY FLASHING SPECIFICATIONS FOR A FULL DESCRIPTION OF INSTALLATION INSTRUCTIONS AND REQUIREMENTS WHICH ARE CONSIDERED A PART OF THIS DETAIL.
3. ANY CARPENTRY OR METAL WORK SHOULD BE DESIGNED AND CONSTRUCTED IN ACCORDANCE WITH LOCAL CODE REQUIREMENTS AND/OR PROJECT SPECIFICATIONS. THESE COMPONENTS SHOULD BE REVIEWED AND APPROVED BY A LICENSED DESIGN PROFESSIONAL.
4. JM TPO EDGE SEALANT IS REQUIRED ON ALL CUT OR NON-ENCAPSULATED EDGES OF REINFORCED MEMBRANE. THIS INCLUDES FACTORY CUT MEMBRANE (SEE DETAIL T-MS-01).
5. FOR MECHANICALLY FASTENED MEMBRANE, MAXIMUM 5' SHEET WIDTH AT PERIMETER.

### Maximum Guarantee Term: 20 Year

Johns Manville is a manufacturer of commercial roofing products and offers this general conceptual information to you as a courtesy. This complimentary assistance is not to be used or relied upon by anyone as a substitute for professional engineering design and documentation required by building code, contract, or applicable law. By accepting these comments you agree they do not constitute any representations, endorsements of, or an assumption by Johns Manville of any liability for either the adequacy of design of this building or any other material not supplied by Johns Manville.

**Note:** For the most current information on general guidelines, please refer to the System Considerations tab under Commercial Roofing Products on the JM Roofing Web site. For specifications, flashing details and general installation information please refer to the Application Tools tab.

Refer to the Safe Use Instructions and product label prior to using this product.







## RhinoPlate - Standing Seam Retro Fit Gutter

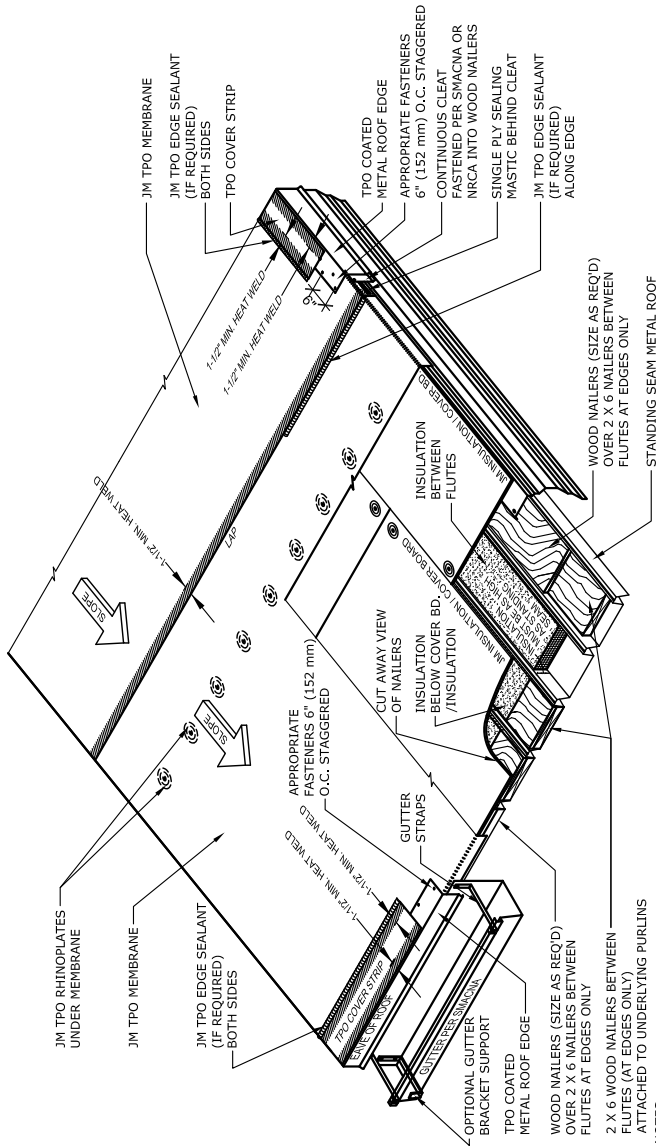

- NOTES:**
1. REFER TO JOHNS MANVILLE WEBSITE ([www.jm.com](http://www.jm.com)) FOR MOST UP-TO-DATE INFORMATION.
  2. SEE SINGLE PLY FLASHING SPECIFICATIONS FOR FULL DESCRIPTION OF INSTALLATION INSTRUCTIONS AND REQUIREMENTS WHICH ARE CONSIDERED A PART OF THIS DETAIL.
  3. ANY REPAIRS OR NEW WORK SHOULD BE DESIGNED AND CONSTRUCTED IN ACCORDANCE WITH LOCAL CODE REQUIREMENTS AND/OR PROJECT SPECIFICATIONS. THESE REPAIRS SHOULD BE REVIEWED AND APPROVED BY A LICENSED DESIGN PROFESSIONAL.
  4. JIM TPO EDGE SEALANT IS REQUIRED ON ALL CUT OR NON-ENCAPSULATED EDGES OF REINFORCED MEMBRANE. THIS INCLUDES FACTORY CUT MEMBRANE. SEE DETAIL T-MS-01).
  5. MEMBRANE LAPS MUST NOT END ON FASTENERS.

### Maximum Guarantee Term: 20 Year

Johns Manville is a manufacturer of commercial roofing products and offers this general conceptual information to you as a courtesy. This complimentary assistance is not to be used or relied upon by anyone as a substitute for professional engineering design and documentation required by building code, contract, or applicable law. By accepting these comments you agree they do not constitute any representations, endorsements of, or an assumption by Johns Manville of any liability for either the adequacy of design of this building or any other material not supplied by Johns Manville.

**Note:** For the most current information on general guidelines, please refer to the System Considerations tab under Commercial Roofing Products on the JM Roofing Web site. For specifications, flashing details and general installation information please refer to the Application Tools tab.

Refer to the Safe Use Instructions and product label prior to using this product.



## Vent Pipe

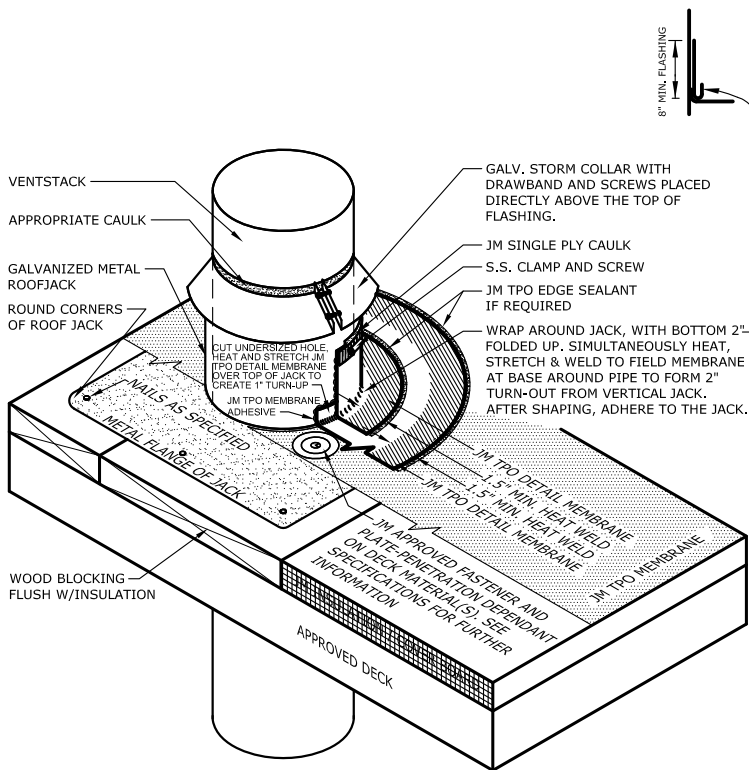

### NOTES:

1. REFER TO JOHNS MANVILLE WEBSITE ([www.jm.com](http://www.jm.com)) FOR MOST UP-TO-DATE INFORMATION.
2. PLEASE SEE SINGLE PLY FLASHING SPECIFICATIONS FOR A FULL DESCRIPTION OF INSTALLATION INSTRUCTIONS AND REQUIREMENTS WHICH ARE CONSIDERED A PART OF THIS DETAIL.
3. ANY CARPENTRY OR METAL WORK SHOULD BE DESIGNED AND CONSTRUCTED IN ACCORDANCE WITH LOCAL CODE REQUIREMENTS AND/OR PROJECT SPECIFICATIONS. THESE COMPONENTS SHOULD BE REVIEWED AND APPROVED BY A LICENSED DESIGN PROFESSIONAL.
4. JM TPO EDGE SEALANT IS REQUIRED ON ALL CUT OR NON-ENCAPSULATED EDGES OF REINFORCED MEMBRANE. THIS INCLUDES FACTORY CUT MEMBRANE (SEE DETAIL T-MS-01)

## Maximum Guarantee Term: 30 Year

Johns Manville is a manufacturer of commercial roofing products and offers this general conceptual information to you as a courtesy. This complimentary assistance is not to be used or relied upon by anyone as a substitute for professional engineering design and documentation required by building code, contract, or applicable law. By accepting these comments you agree they do not constitute any representations, endorsements of, or an assumption by Johns Manville of any liability for either the adequacy of design of this building or any other material not supplied by Johns Manville.

**Note:** For the most current information on general guidelines, please refer to the System Considerations tab under Commercial Roofing Products on the JM Roofing Web site. For specifications, flashing details and general installation information please refer to the Application Tools tab.

Refer to the Safe Use Instructions and product label prior to using this product.



## Vent Pipe - Hot

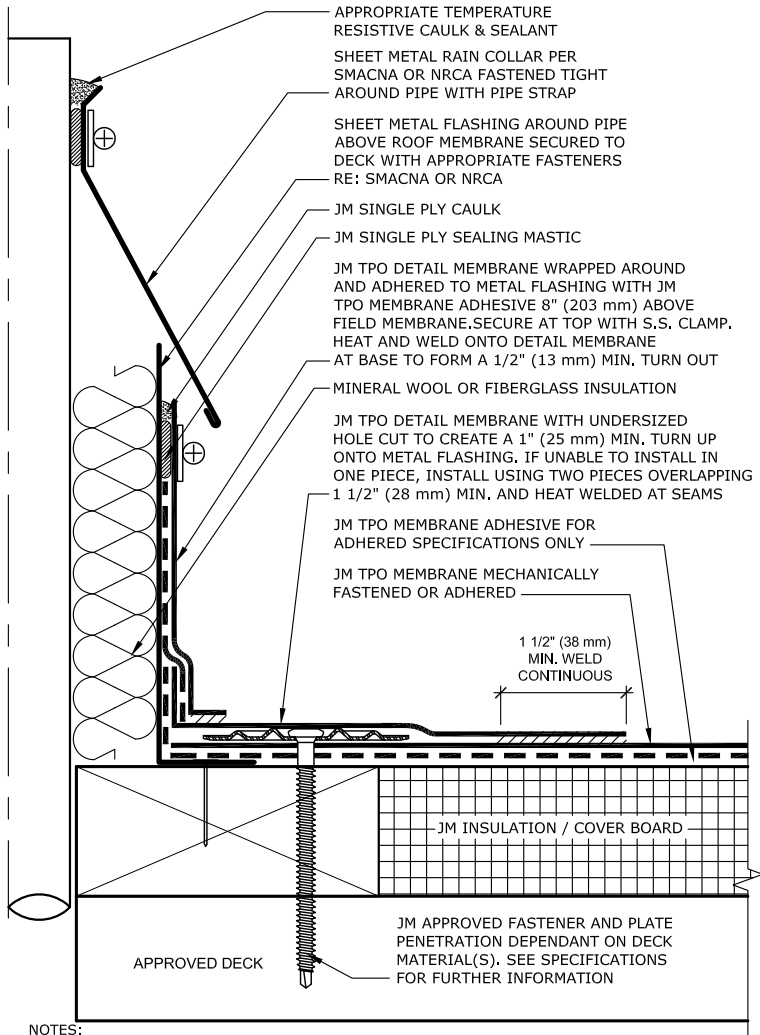

### NOTES:

1. REFER TO JOHNS MANVILLE WEBSITE ([www.jm.com](http://www.jm.com)) FOR MOST UP TO DATE INFORMATION.
2. PLEASE SEE SINGLE PLY FLASHING SPECIFICATIONS FOR A FULL DESCRIPTION OF INSTALLATION INSTRUCTIONS AND REQUIREMENTS WHICH ARE CONSIDERED A PART OF THIS DETAIL.
3. ANY CARPENTRY OR METAL WORK SHOULD BE DESIGNED AND CONSTRUCTED IN ACCORDANCE WITH LOCAL CODE REQUIREMENTS AND/OR PROJECT SPECIFICATIONS. THESE COMPONENTS SHOULD BE REVIEWED AND APPROVED BY A LICENSED DESIGN PROFESSIONAL.
4. JM TPO EDGE SEALANT IS REQUIRED ON ALL CUT OR NON ENCAPSULATED EDGES OF REINFORCED MEMBRANE. THIS INCLUDES FACTORY CUT MEMBRANE (SEE DETAIL T-MS-01).
5. MAXIMUM 150 DEGREES FAHRENHEIT AT SURFACE OF OUTER SHEET METAL FLASHING.

## Maximum Guarantee Term: 30 Year

Johns Manville is a manufacturer of commercial roofing products and offers this general conceptual information to you as a courtesy. This complimentary assistance is not to be used or relied upon by anyone as a substitute for professional engineering design and documentation required by building code, contract, or applicable law. By accepting these comments you agree they do not constitute any representations, endorsements of, or an assumption by Johns Manville of any liability for either the adequacy of design of this building or any other material not supplied by Johns Manville.

**Note:** For the most current information on general guidelines, please refer to the System Considerations tab under Commercial Roofing Products on the JM Roofing Web site. For specifications, flashing details and general installation information please refer to the Application Tools tab.

Refer to the Safe Use Instructions and product label prior to using this product.





## Throughwall Scupper

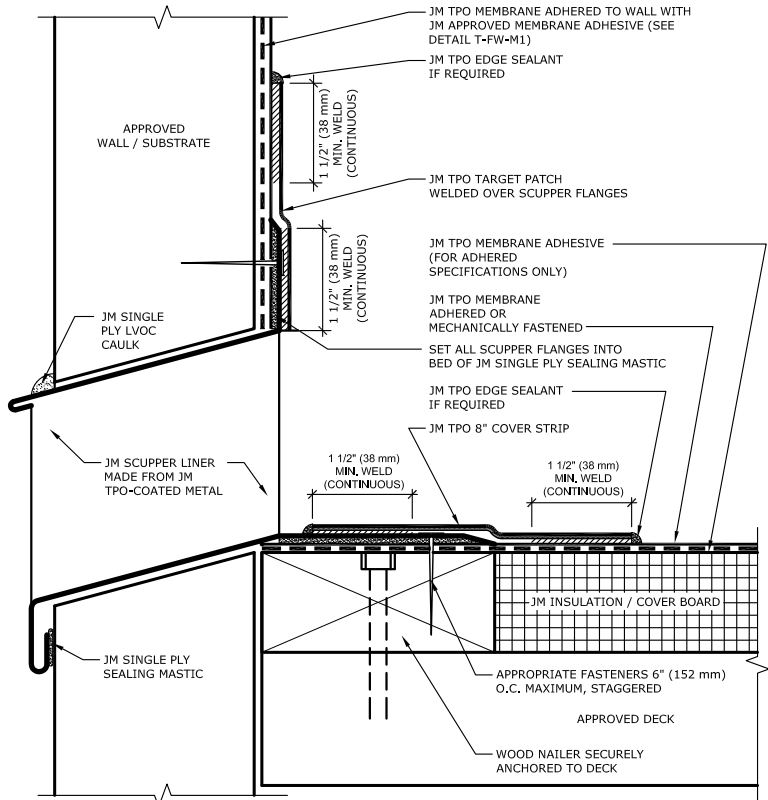

### NOTES:

1. REFER TO JOHNS MANVILLE WEBSITE ([www.jm.com](http://www.jm.com)) FOR MOST UP-TO-DATE INFORMATION.
2. PLEASE SEE SINGLE PLY FLASHING SPECIFICATIONS FOR A FULL DESCRIPTION OF INSTALLATION INSTRUCTIONS AND REQUIREMENTS WHICH ARE CONSIDERED A PART OF THIS DETAIL.
3. ANY CARPENTRY OR METAL WORK SHOULD BE DESIGNED AND CONSTRUCTED IN ACCORDANCE WITH LOCAL CODE REQUIREMENTS AND/OR PROJECT SPECIFICATIONS. THESE COMPONENTS SHOULD BE REVIEWED AND APPROVED BY A LICENSED DESIGN PROFESSIONAL.
4. JM TPO EDGE SEALANT IS REQUIRED ON ALL CUT OR NON-ENCAPSULATED EDGES OF REINFORCED MEMBRANE. THIS INCLUDES FACTORY CUT MEMBRANE (SEE DETAIL T-MS-01).
5. ALL SEALANTS / CAULKING SHALL BE PERIODICALLY INSPECTED AND MAINTAINED BY THE BUILDING OWNER THROUGHOUT THE LIFE OF THE ROOF.

## Maximum Guarantee Term: 30 Year

Johns Manville is a manufacturer of commercial roofing products and offers this general conceptual information to you as a courtesy. This complimentary assistance is not to be used or relied upon by anyone as a substitute for professional engineering design and documentation required by building code, contract, or applicable law. By accepting these comments you agree they do not constitute any representations, endorsements of, or an assumption by Johns Manville of any liability for either the adequacy of design of this building or any other material not supplied by Johns Manville.

**Note:** For the most current information on general guidelines, please refer to the System Considerations tab under Commercial Roofing Products on the JM Roofing Web site. For specifications, flashing details and general installation information please refer to the Application Tools tab.

Refer to the Safe Use Instructions and product label prior to using this product.



## Throughwall Scupper

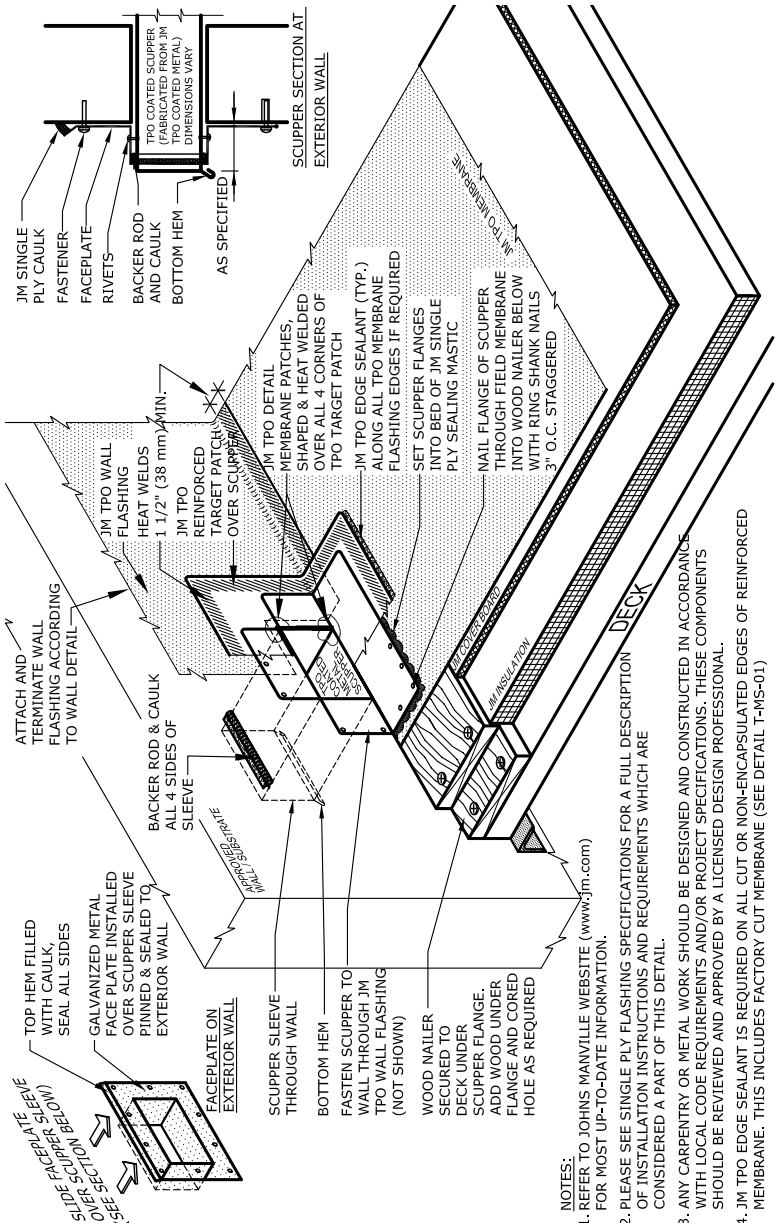

- NOTES:**
1. REFER TO JOHNS MANVILLE WEBSITE ([www.jm.com](http://www.jm.com)) FOR MOST UP-TO-DATE INFORMATION.
  2. PLEASE SEE SINGLE PLY FLASHING SPECIFICATIONS FOR A FULL DESCRIPTION OF INSTALLATION INSTRUCTIONS AND REQUIREMENTS WHICH ARE CONSIDERED A PART OF THIS DETAIL.
  3. ANY CARPENTRY OR METAL WORK SHOULD BE DESIGNED AND CONSTRUCTED IN ACCORDANCE WITH LOCAL CODE REQUIREMENTS AND/OR PROJECT SPECIFICATIONS. THESE COMPONENTS SHOULD BE REVIEWED AND APPROVED BY A LICENSED DESIGN PROFESSIONAL.
  4. JM TPO EDGE SEALANT IS REQUIRED ON ALL CUT OR NON-ENCAPSULATED EDGES OF REINFORCED MEMBRANE. THIS INCLUDES FACTORY CUT MEMBRANE (SEE DETAIL T-MS-01)

### Maximum Guarantee Term: 30 Year

Johns Manville is a manufacturer of commercial roofing products and offers this general conceptual information to you as a courtesy. This complimentary assistance is not to be used or relied upon by anyone as a substitute for professional engineering design and documentation required by building code, contract, or applicable law. By accepting these comments you agree they do not constitute any representations, endorsements, or an assumption by Johns Manville of any liability for either the adequacy of design of this building or any other material not supplied by Johns Manville.

**Note:** For the most current information on general guidelines, please refer to the System Considerations tab under Commercial Roofing Products on the JM Roofing Web site. For specifications, flashing details and general installation information please refer to the Application Tools tab.

Refer to the Safe Use Instructions and product label prior to using this product.



## Primary Scupper with Tapered Insulation Sump

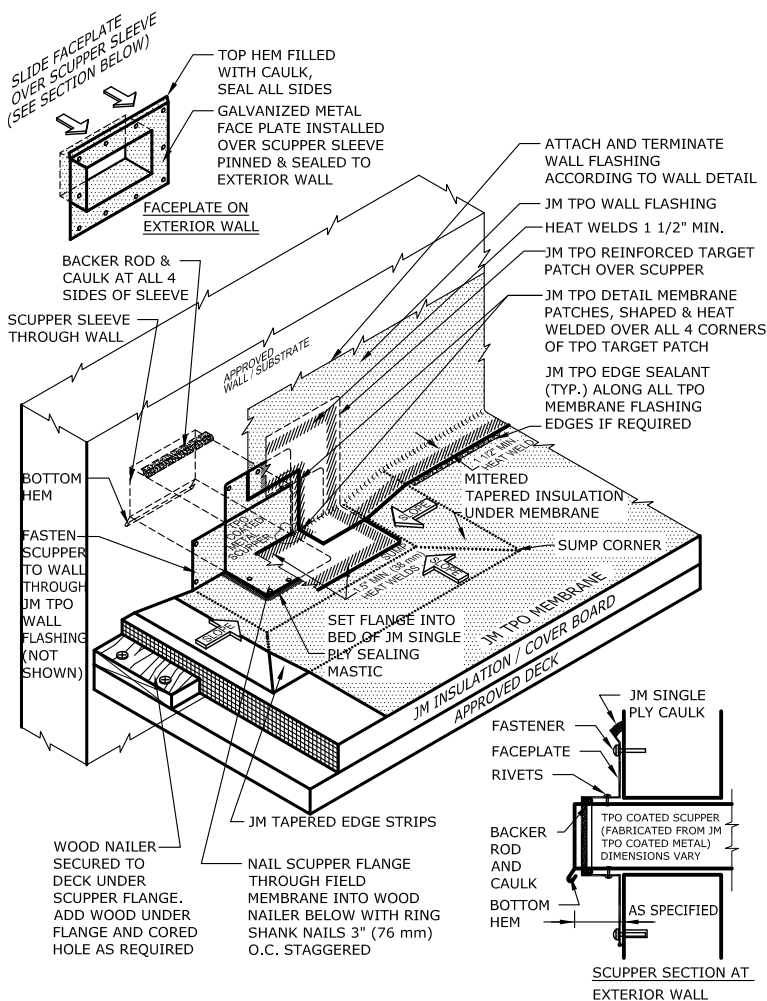

### NOTES:

1. REFER TO JOHNS MANVILLE WEBSITE ([www.jm.com](http://www.jm.com)) FOR MOST UP-TO-DATE INFORMATION.
2. PLEASE SEE SINGLE PLY FLASHING SPECIFICATIONS FOR A FULL DESCRIPTION OF INSTALLATION INSTRUCTIONS AND REQUIREMENTS WHICH ARE CONSIDERED A PART OF THIS DETAIL.
3. ANY CARPENTRY OR METAL WORK SHOULD BE DESIGNED AND CONSTRUCTED IN ACCORDANCE WITH LOCAL CODE REQUIREMENTS AND/OR PROJECT SPECIFICATIONS. THESE COMPONENTS SHOULD BE REVIEWED AND APPROVED BY A LICENSED DESIGN PROFESSIONAL.
4. JM TPO EDGE SEALANT IS REQUIRED ON ALL CUT OR NON-ENCAPSULATED EDGES OF REINFORCED MEMBRANE. THIS INCLUDES FACTORY CUT MEMBRANE (SEE DETAIL T-MS-01)

## Maximum Guarantee Term: 20 Year

Johns Manville is a manufacturer of commercial roofing products and offers this general conceptual information to you as a courtesy. This complimentary assistance is not to be used or relied upon by anyone as a substitute for professional engineering design and documentation required by building code, contract, or applicable law. By accepting these comments you agree they do not constitute any representations, endorsements of, or an assumption by Johns Manville of any liability for either the adequacy of design of this building or any other material not supplied by Johns Manville.

**Note:** For the most current information on general guidelines, please refer to the System Considerations tab under Commercial Roofing Products on the JM Roofing Web site. For specifications, flashing details and general installation information please refer to the Application Tools tab.

Refer to the Safe Use Instructions and product label prior to using this product.



## Low Wall Primary Scupper Flashing

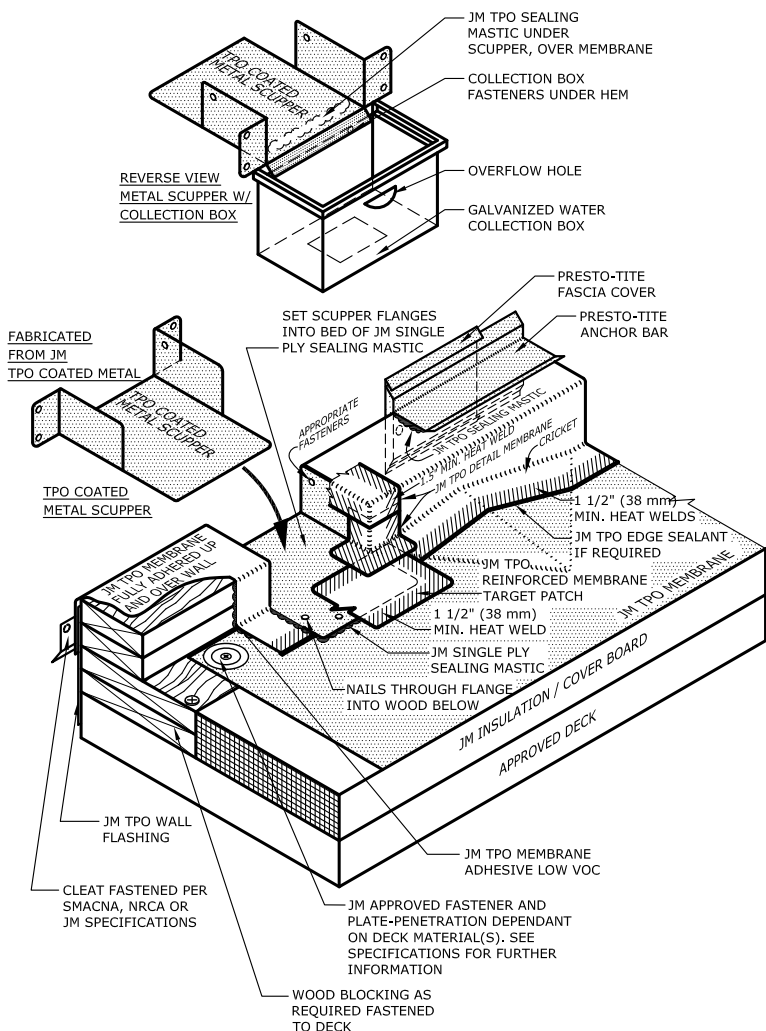

### NOTES:

1. REFER TO JOHNS MANVILLE WEBSITE ([www.jm.com](http://www.jm.com)) FOR MOST UP-TO-DATE INFORMATION.
2. PLEASE SEE SINGLE PLY FLASHING SPECIFICATIONS FOR A FULL DESCRIPTION OF INSTALLATION INSTRUCTIONS AND REQUIREMENTS WHICH ARE CONSIDERED A PART OF THIS DETAIL.
3. ANY CARPENTRY OR METAL WORK SHOULD BE DESIGNED AND CONSTRUCTED IN ACCORDANCE WITH LOCAL CODE REQUIREMENTS AND/OR PROJECT SPECIFICATIONS. THESE COMPONENTS SHOULD BE REVIEWED AND APPROVED BY A LICENSED DESIGN PROFESSIONAL.
4. JM TPO EDGE SEALANT IS REQUIRED ON ALL CUT OR NON-ENCAPSULATED EDGES OF REINFORCED MEMBRANE. THIS INCLUDES FACTORY CUT MEMBRANE (SEE DETAIL T-MS-01)

## Maximum Guarantee Term: 30 Year

Johns Manville is a manufacturer of commercial roofing products and offers this general conceptual information to you as a courtesy. This complimentary assistance is not to be used or relied upon by anyone as a substitute for professional engineering design and documentation required by building code, contract, or applicable law. By accepting these comments you agree they do not constitute any representations, endorsements of, or an assumption by Johns Manville of any liability for either the adequacy of design of this building or any other material not supplied by Johns Manville.

**Note:** For the most current information on general guidelines, please refer to the System Considerations tab under Commercial Roofing Products on the JM Roofing Web site. For specifications, flashing details and general installation information please refer to the Application Tools tab.

Refer to the Safe Use Instructions and product label prior to using this product.



## Overflow Scupper

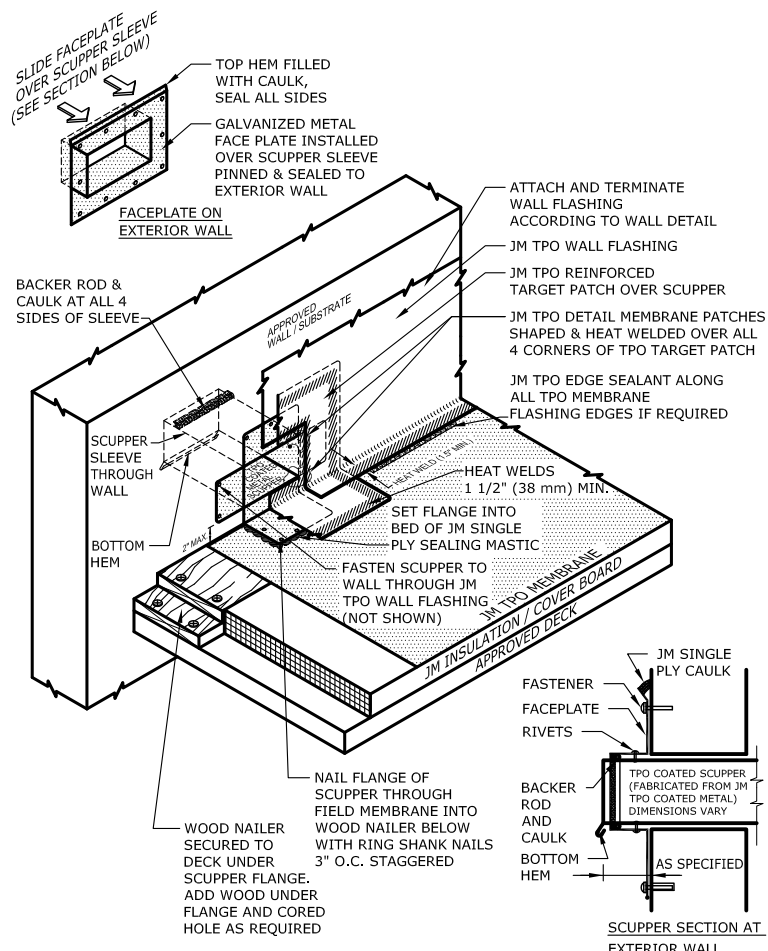

### NOTES:

1. REFER TO JOHNS MANVILLE WEBSITE ([www.jm.com](http://www.jm.com)) FOR MOST UP-TO-DATE INFORMATION.
2. PLEASE SEE SINGLE PLY FLASHING SPECIFICATIONS FOR A FULL DESCRIPTION OF INSTALLATION INSTRUCTIONS AND REQUIREMENTS WHICH ARE CONSIDERED A PART OF THIS DETAIL.
3. ANY CARPENTRY OR METAL WORK SHOULD BE DESIGNED AND CONSTRUCTED IN ACCORDANCE WITH LOCAL CODE REQUIREMENTS AND/OR PROJECT SPECIFICATIONS. THESE COMPONENTS SHOULD BE REVIEWED AND APPROVED BY A LICENSED DESIGN PROFESSIONAL.
4. JM TPO EDGE SEALANT IS REQUIRED ON ALL CUT OR NON-ENCAPSULATED EDGES OF REINFORCED MEMBRANE. THIS INCLUDES FACTORY CUT MEMBRANE (SEE DETAIL T-MS-01)

## Maximum Guarantee Term: 20 Year

Johns Manville is a manufacturer of commercial roofing products and offers this general conceptual information to you as a courtesy. This complimentary assistance is not to be used or relied upon by anyone as a substitute for professional engineering design and documentation required by building code, contract, or applicable law. By accepting these comments you agree they do not constitute any representations, endorsements of, or an assumption by Johns Manville of any liability for either the adequacy of design of this building or any other material not supplied by Johns Manville.

**Note:** For the most current information on general guidelines, please refer to the System Considerations tab under Commercial Roofing Products on the JM Roofing Web site. For specifications, flashing details and general installation information please refer to the Application Tools tab.

Refer to the Safe Use Instructions and product label prior to using this product.



## Primary Drain Sump - Low Slope - Up to 3:12 Slope

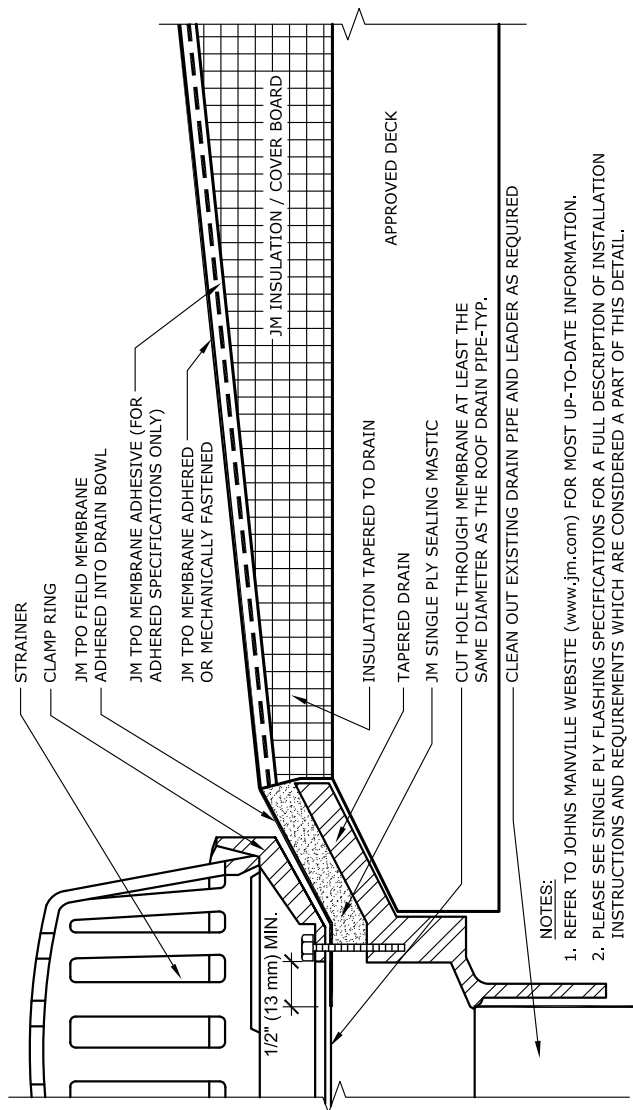

- NOTES:**
1. REFER TO JOHNS MANVILLE WEBSITE ([www.jm.com](http://www.jm.com)) FOR MOST UP-TO-DATE INFORMATION.
  2. PLEASE SEE SINGLE PLY FLASHING SPECIFICATIONS FOR A FULL DESCRIPTION OF INSTALLATION INSTRUCTIONS AND REQUIREMENTS WHICH ARE CONSIDERED A PART OF THIS DETAIL.
  3. ANY CARPENTRY OR METAL WORK SHOULD BE DESIGNED AND CONSTRUCTED IN ACCORDANCE WITH LOCAL CODE REQUIREMENTS AND/OR PROJECT SPECIFICATIONS. THESE COMPONENTS SHOULD BE REVIEWED AND APPROVED BY A LICENSED DESIGN PROFESSIONAL.
  4. JM TPO EDGE SEALANT IS REQUIRED ON ALL CUT OR NON-ENCAPSULATED EDGES OF REINFORCED MEMBRANE. THIS INCLUDES FACTORY CUT MEMBRANE (SEE DETAIL T-MS-01).
  5. REPLACE ANY BROKEN COMPONENTS (DRAINS, RINGS, BOLTS, ETC.)

TPO Flashing Details

### Maximum Guarantee Term: 30 Year

Johns Manville is a manufacturer of commercial roofing products and offers this general conceptual information to you as a courtesy. This complimentary assistance is not to be used or relied upon by anyone as a substitute for professional engineering design and documentation required by building code, contract, or applicable law. By accepting these comments you agree they do not constitute any representations, endorsements of, or an assumption by Johns Manville of any liability for either the adequacy of design of this building or any other material not supplied by Johns Manville.

**Note:** For the most current information on general guidelines, please refer to the System Considerations tab under Commercial Roofing Products on the JM Roofing Web site. For specifications, flashing details and general installation information please refer to the Application Tools tab.

Refer to the Safe Use Instructions and product label prior to using this product.



## Primary Drain Sump - Steep Slope - Greater Than 3:12 Slope

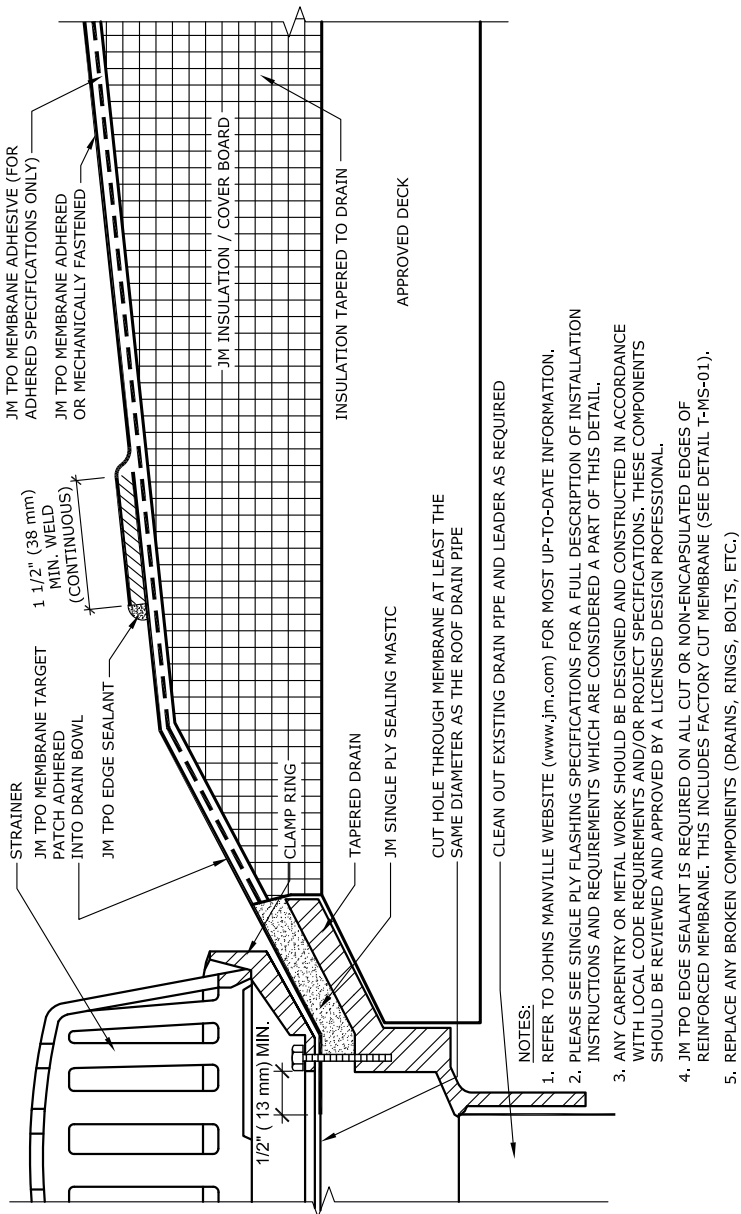

### Maximum Guarantee Term: 30 Year

Johns Manville is a manufacturer of commercial roofing products and offers this general conceptual information to you as a courtesy. This complimentary assistance is not to be used or relied upon by anyone as a substitute for professional engineering design and documentation required by building code, contract, or applicable law. By accepting these comments you agree they do not constitute any representations, endorsements of, or an assumption by Johns Manville of any liability for either the adequacy of design of this building or any other material not supplied by Johns Manville.

**Note:** For the most current information on general guidelines, please refer to the System Considerations tab under Commercial Roofing Products on the JM Roofing Web site. For specifications, flashing details and general installation information please refer to the Application Tools tab.

Refer to the Safe Use Instructions and product label prior to using this product.



## Primary Drain Sump - Fleece-Backed Membrane

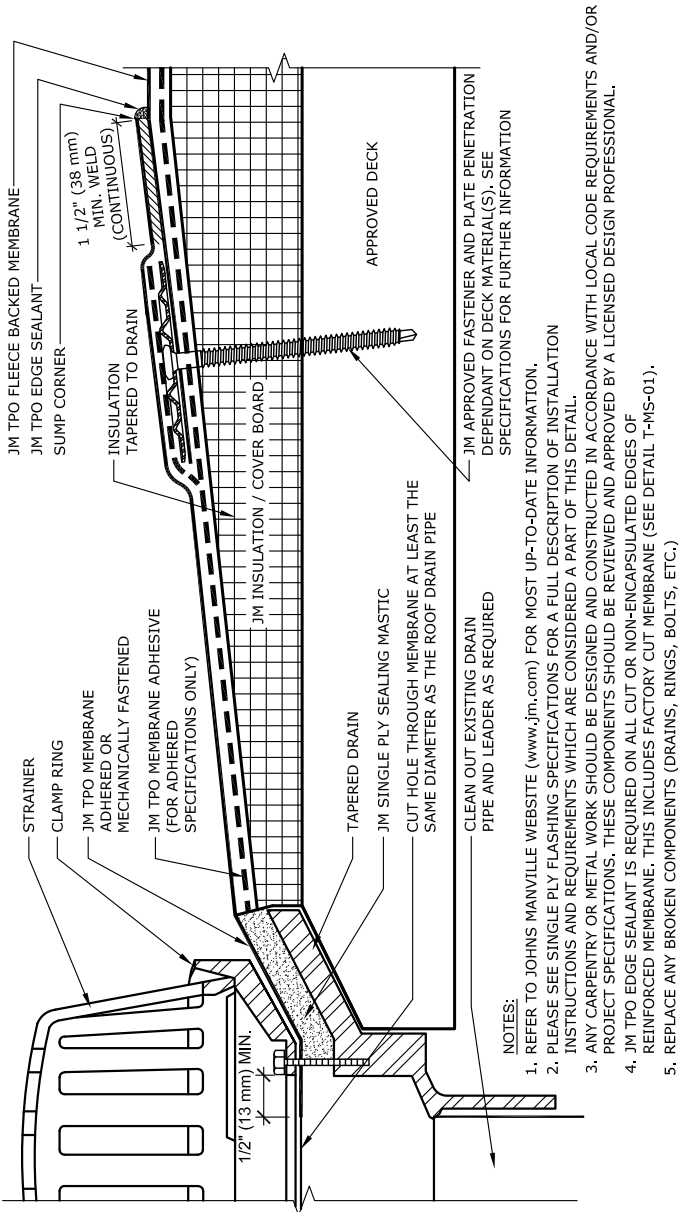

### Maximum Guarantee Term: 30 Year

Johns Manville is a manufacturer of commercial roofing products and offers this general conceptual information to you as a courtesy. This complimentary assistance is not to be used or relied upon by anyone as a substitute for professional engineering design and documentation required by building code, contract, or applicable law. By accepting these comments you agree they do not constitute any representations, endorsements of, or an assumption by Johns Manville of any liability for either the adequacy of design of this building or any other material not supplied by Johns Manville.

**Note:** For the most current information on general guidelines, please refer to the System Considerations tab under Commercial Roofing Products on the JM Roofing Web site. For specifications, flashing details and general installation information please refer to the Application Tools tab.

Refer to the Safe Use Instructions and product label prior to using this product.







## JM Heavy-Duty TPO Retro Drain

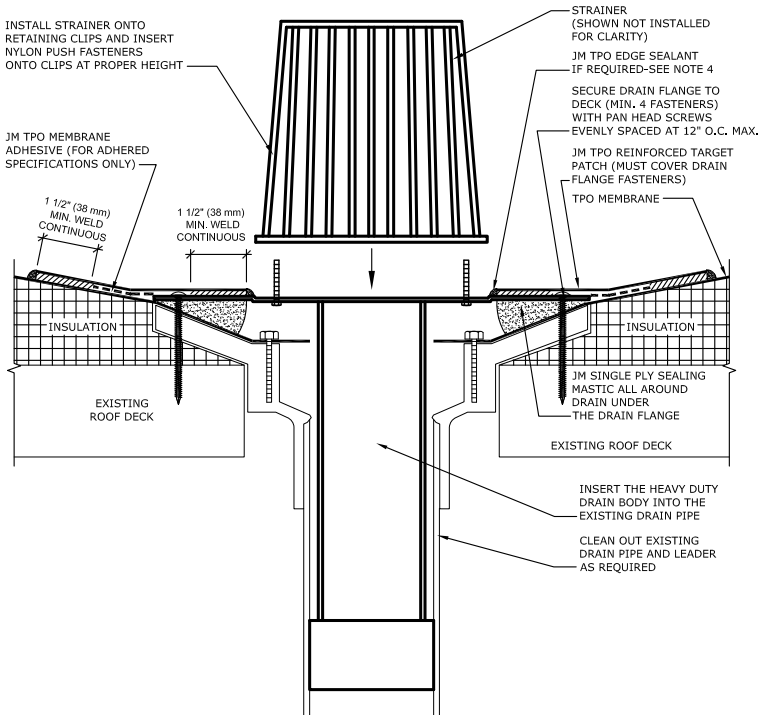

### NOTES:

1. REFER TO JOHNS MANVILLE WEBSITE ([www.jm.com](http://www.jm.com)) FOR MOST UP-TO-DATE INFORMATION.
2. PLEASE SEE SINGLE PLY FLASHING SPECIFICATIONS FOR A FULL DESCRIPTION OF INSTALLATION INSTRUCTIONS AND REQUIREMENTS WHICH ARE CONSIDERED A PART OF THIS DETAIL.
3. ANY CARPENTRY OR METAL WORK SHOULD BE DESIGNED AND CONSTRUCTED IN ACCORDANCE WITH LOCAL CODE REQUIREMENTS AND/OR PROJECT SPECIFICATIONS. THESE COMPONENTS SHOULD BE REVIEWED AND APPROVED BY A LICENSED DESIGN PROFESSIONAL.
4. JM TPO EDGE SEALANT IS REQUIRED ON ALL CUT OR NON-ENCAPSULATED EDGES OF REINFORCED MEMBRANE. THIS INCLUDES FACTORY CUT MEMBRANE (SEE DETAIL T-MS-01).
5. REPLACE ANY BROKEN COMPONENTS (DRAINS, RINGS, BOLTS, ETC.)
6. SUMP AREA MUST BE PROPERLY TAPERED SO THAT THE DRAIN FLASHING IS NOT INSTALLED UNDER TENSION.

## Maximum Guarantee Term: 20 Year

Johns Manville is a manufacturer of commercial roofing products and offers this general conceptual information to you as a courtesy. This complimentary assistance is not to be used or relied upon by anyone as a substitute for professional engineering design and documentation required by building code, contract, or applicable law. By accepting these comments you agree they do not constitute any representations, endorsements of, or an assumption by Johns Manville of any liability for either the adequacy of design of this building or any other material not supplied by Johns Manville.

**Note:** For the most current information on general guidelines, please refer to the System Considerations tab under Commercial Roofing Products on the JM Roofing Web site. For specifications, flashing details and general installation information please refer to the Application Tools tab.

Refer to the Safe Use Instructions and product label prior to using this product.



## Primary Drain Sump - Mechanically Fastened Membrane

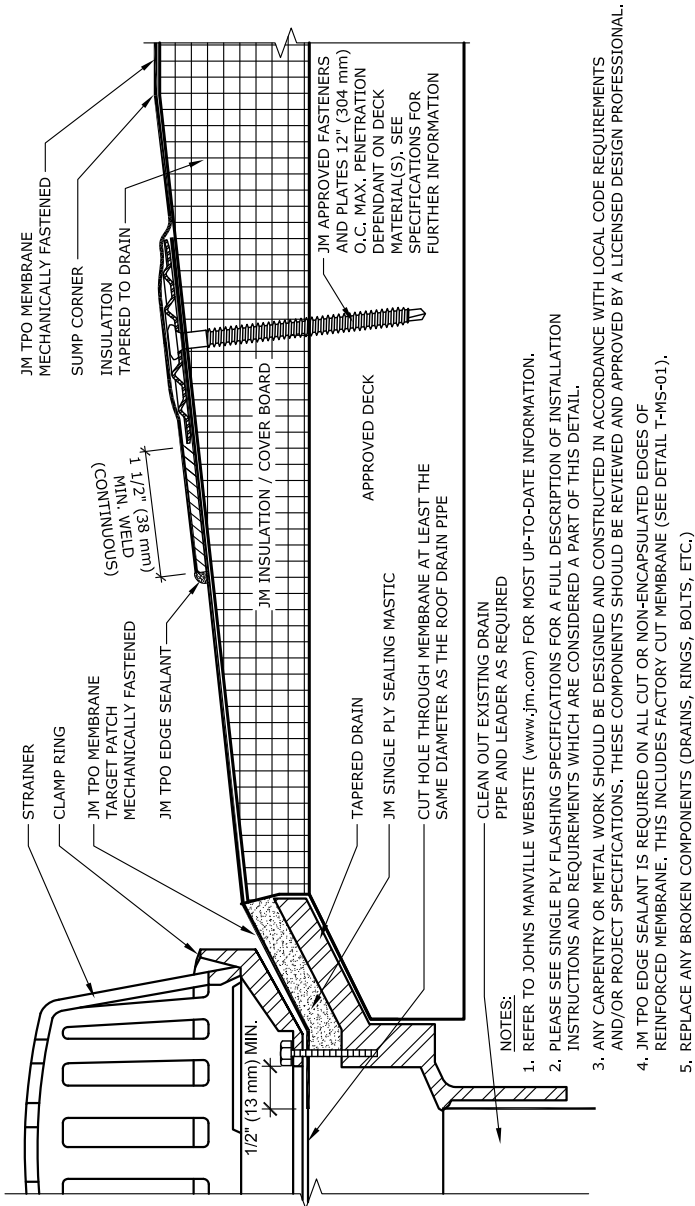

### Maximum Guarantee Term: 30 Year

Johns Manville is a manufacturer of commercial roofing products and offers this general conceptual information to you as a courtesy. This complimentary assistance is not to be used or relied upon by anyone as a substitute for professional engineering design and documentation required by building code, contract, or applicable law. By accepting these comments you agree they do not constitute any representations, endorsements of, or an assumption by Johns Manville of any liability for either the adequacy of design of this building or any other material not supplied by Johns Manville.

**Note:** For the most current information on general guidelines, please refer to the System Considerations tab under Commercial Roofing Products on the JM Roofing Web site. For specifications, flashing details and general installation information please refer to the Application Tools tab.

Refer to the Safe Use Instructions and product label prior to using this product.



## TPO Pipe Boot

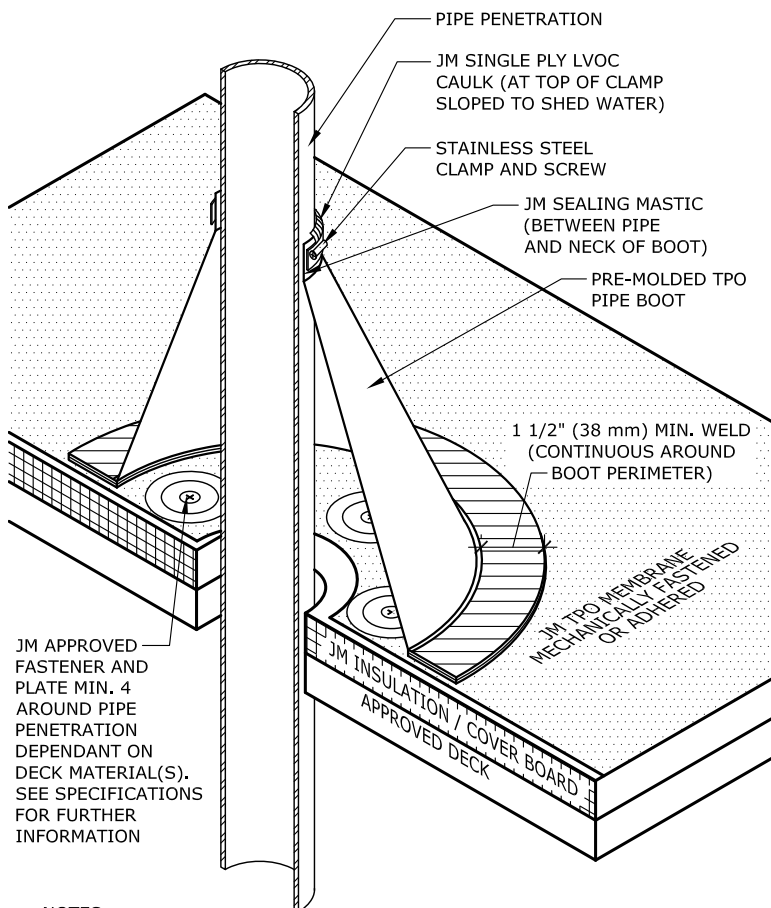

### NOTES:

1. REFER TO JOHNS MANVILLE WEBSITE ([www.jm.com](http://www.jm.com)) FOR MOST UP-TO-DATE INFORMATION.
2. PLEASE SEE SINGLE FLASHING SPECIFICATIONS FOR A FULL DESCRIPTION OF INSTALLATION INSTRUCTIONS AND REQUIREMENTS WHICH ARE CONSIDERED A PART OF THIS DETAIL.
3. ANY CARPENTRY OR METAL WORK SHOULD BE DESIGNED AND CONSTRUCTED IN ACCORDANCE WITH LOCAL CODE REQUIREMENTS AND/OR PROJECT SPECIFICATIONS. THESE COMPONENTS SHOULD BE REVIEWED AND APPROVED BY A LICENSED DESIGN PROFESSIONAL.

## Maximum Guarantee Term: 30 Year

Johns Manville is a manufacturer of commercial roofing products and offers this general conceptual information to you as a courtesy. This complimentary assistance is not to be used or relied upon by anyone as a substitute for professional engineering design and documentation required by building code, contract, or applicable law. By accepting these comments you agree they do not constitute any representations, endorsements of, or an assumption by Johns Manville of any liability for either the adequacy of design of this building or any other material not supplied by Johns Manville.

**Note:** For the most current information on general guidelines, please refer to the System Considerations tab under Commercial Roofing Products on the JM Roofing Web site. For specifications, flashing details and general installation information please refer to the Application Tools tab.

Refer to the Safe Use Instructions and product label prior to using this product.



## JM TPO 2 Piece Penetration Pocket

JM APPROVED FASTENER & PLATE - INSTALL 2 AROUND PENETRATION AS SHOWN. PLATES MUST NOT BE LOCATED UNDER THE WELDED FLANGE. INSTALL A TARGET PATCH IF PLATES CONTACT THE WELDED FLANGE.

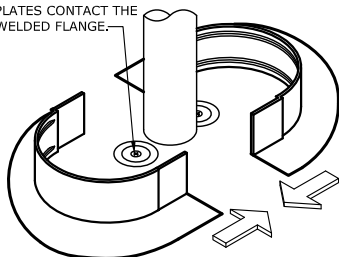

### JM TPO 2 PIECE PENETRATION POCKET

THE JM TPO PENETRATION POCKET IS A TWO-PIECE MOLDED POCKET WITH A RIGID VERTICAL WALL AND PRE-FORMED FLANGE AS SHOWN

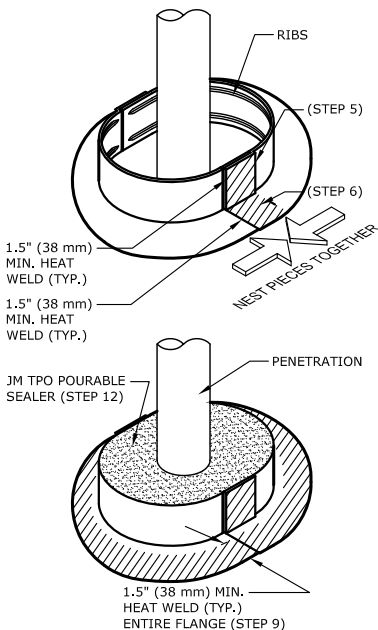

### INSTALLATION STEPS:

1. USING A WIRE BRUSH OR GRINDER, CLEAN PENETRATION DOWN TO BARE METAL FROM JUST BELOW THE MEMBRANE SURFACE TO JUST ABOVE THE TOP OF THE TPO PENETRATION PAN COLLAR TO ALLOW GOOD ADHESION BETWEEN THE PENETRATION AND THE JM TPO POURABLE SEALER.
2. USING JM SINGLE PLY MEMBRANE CLEANER, CLEAN THE INSIDE OF THE JM TPO PENETRATION POCKET. ALSO, CLEAN AREAS WHERE THE POCKET OVERLAPS THE UNDERSIDE OF THE POCKET FLANGE AND MEMBRANE.
3. PLACE THE JM TPO PENETRATION POCKET AROUND THE PENETRATION, NESTING THE TWO SECTIONS OF THE POCKET TOGETHER.
4. USING A 4" x 4" PIECE OF THICK CARDBOARD AS A HEAT SEPARATION SHEET, PLACE CARDBOARD UNDER OVERLAP SECTION OF PENETRATION PAN.
5. USING A HANDWELDER, WELD THE 2 PIECE "VERTICAL" COLLAR TOGETHER FROM THE 90 DEGREE VERTICAL / HORIZONTAL ANGLE CHANGE, TO THE TOP OF THE VERTICAL TPO COLLAR, BEING CAREFUL TO AVOID COLD WELDS AND VOIDS. (POSITION THE POCKET SO THE VERTICAL LAP IS AGAINST THE PENETRATION. THIS ALLOWS PROPER PRESSURE TO BE APPLIED TO THE OVERLAP WITH A 2" SILICONE ROLLER.)
6. USING A HANDWELDER, WELD THE 2 PIECE "HORIZONTAL" COLLAR TOGETHER FROM THE 90 DEGREE VERTICAL / HORIZONTAL ANGLE CHANGE, TO THE OUTSIDE EDGE OF THE HORIZONTAL TPO POCKET FLANGE, BEING CAREFUL TO AVOID COLD WELDS AND VOIDS. (POSITION THE POCKET SO THE HORIZONTAL LAP IS AGAINST THE CARDBOARD. THIS ALLOWS PROPER PRESSURE TO BE APPLIED TO THE OVERLAP WITH A 2" SILICONE ROLLER.)
7. REPEAT STEPS 5 AND 6 TO WELD THE OVERLAPS OF THE OPPOSITE SIDE OF THE PENETRATION PAN.
8. IF NECESSARY, TACK WELD THE PENETRATION POCKET IN PLACE AROUND THE PENETRATION, LEAVING A MINIMUM ONE INCH SPACE BETWEEN THE PENETRATION AND THE TPO PENETRATION COLLAR.
9. WELD THE ENTIRE HORIZONTAL FLANGE TO THE TPO FIELD MEMBRANE.
10. USING A SEAM PROBE, CHECK ALL LAPS FOR COLD WELDS AND VOIDS. MAKE ANY NECESSARY REPAIRS.
11. USING A SMALL PAINT BRUSH, APPLY A THIN COAT OF JM TPO PRIMER TO THE INSIDE RIM AND AROUND THE TOP RIM OF THE POCKET. ALSO APPLY PRIMER TO THE MEMBRANE AREA ENCLOSED BY THE POCKET AND THE PENETRATION ITSELF.
12. FILL THE POCKET WITH JM TPO POURABLE SEALER. USE AN ADEQUATE AMOUNT OF SEALANT TO ENSURE PROPER CONTACT IS MADE WITH THE TOP RIM OF THE POCKET.
13. POURABLE SEALER IS A SEALANT TO BE MAINTAINED BY THE OWNER.

## Maximum Guarantee Term: 20 Year

Johns Manville is a manufacturer of commercial roofing products and offers this general conceptual information to you as a courtesy. This complimentary assistance is not to be used or relied upon by anyone as a substitute for professional engineering design and documentation required by building code, contract, or applicable law. By accepting these comments you agree they do not constitute any representations, endorsements of, or an assumption by Johns Manville of any liability for either the adequacy of design of this building or any other material not supplied by Johns Manville.

**Note:** For the most current information on general guidelines, please refer to the System Considerations tab under Commercial Roofing Products on the JM Roofing Web site. For specifications, flashing details and general installation information please refer to the Application Tools tab.

Refer to the Safe Use Instructions and product label prior to using this product.



## TPO-Coated Metal Penetration Pocket

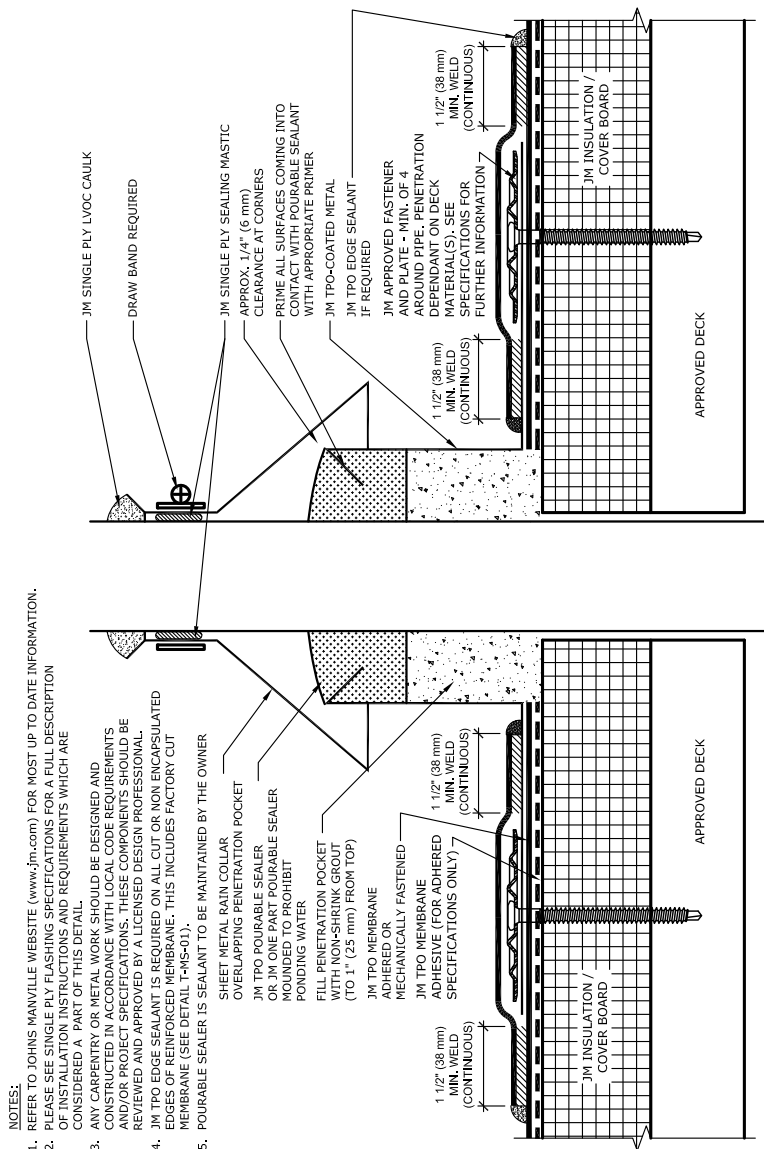

## Maximum Guarantee Term: 20 Year

Johns Manville is a manufacturer of commercial roofing products and offers this general conceptual information to you as a courtesy. This complimentary assistance is not to be used or relied upon by anyone as a substitute for professional engineering design and documentation required by building code, contract, or applicable law. By accepting these comments you agree they do not constitute any representations, endorsements of, or an assumption by Johns Manville of any liability for either the adequacy of design of this building or any other material not supplied by Johns Manville.

**Note:** For the most current information on general guidelines, please refer to the System Considerations tab under Commercial Roofing Products on the JM Roofing Web site. For specifications, flashing details and general installation information please refer to the Application Tools tab.

Refer to the Safe Use Instructions and product label prior to using this product.



## TPO Split Pipe Boot - Round

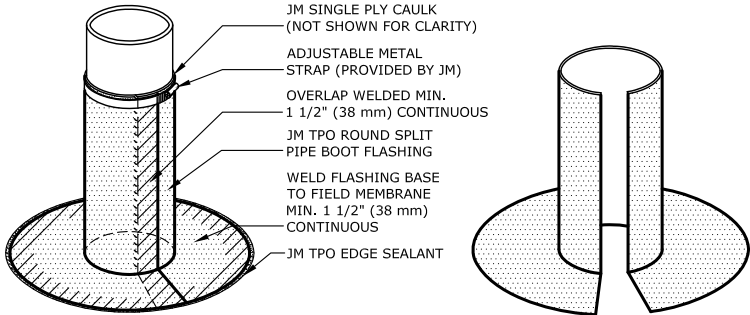

**INSTALLED BOOT  
ISOMETRIC VIEW**

**UNINSTALLED BOOT  
ISOMETRIC VIEW**

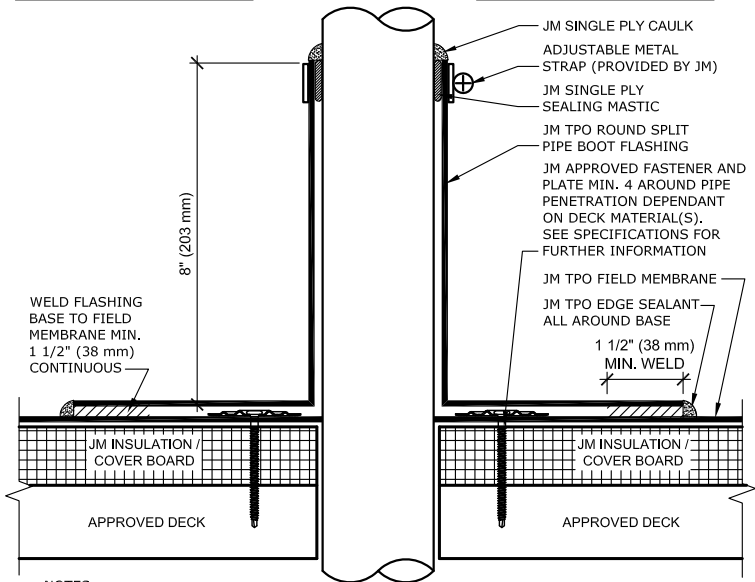

**NOTES:**

1. REFER TO JOHNS MANVILLE WEBSITE ([www.jm.com](http://www.jm.com)) FOR MOST UP-TO-DATE INFORMATION.
2. ANY CARPENTRY OR METAL WORK SHOULD BE DESIGNED AND CONSTRUCTED IN ACCORDANCE WITH LOCAL CODE REQUIREMENTS AND/OR PROJECT SPECIFICATIONS. THESE COMPONENTS SHOULD BE REVIEWED AND APPROVED BY A LICENSED DESIGN PROFESSIONAL.
3. STANDARD JM ROUND SPLIT PIPE BOOT SIZES ARE 1", 2", 3", 4", 5" & 6".

### Maximum Guarantee Term: 20 Year

Johns Manville is a manufacturer of commercial roofing products and offers this general conceptual information to you as a courtesy. This complimentary assistance is not to be used or relied upon by anyone as a substitute for professional engineering design and documentation required by building code, contract, or applicable law. By accepting these comments you agree they do not constitute any representations, endorsements of, or an assumption by Johns Manville of any liability for either the adequacy of design of this building or any other material not supplied by Johns Manville.

**Note:** For the most current information on general guidelines, please refer to the System Considerations tab under Commercial Roofing Products on the JM Roofing Web site. For specifications, flashing details and general installation information please refer to the Application Tools tab.

Refer to the Safe Use Instructions and product label prior to using this product.



## TPO Split Pipe Boot - Square

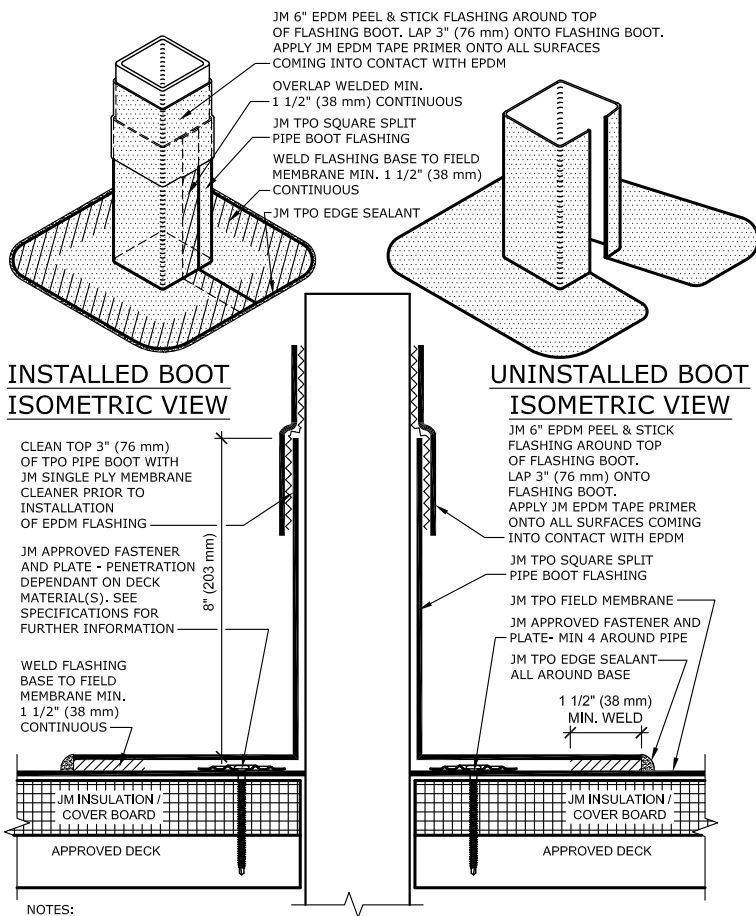

**NOTES:**

1. REFER TO JOHNS MANVILLE WEBSITE ([www.jm.com](http://www.jm.com)) FOR MOST UP-TO-DATE INFORMATION.
2. ANY CARPENTRY OR METAL WORK SHOULD BE DESIGNED AND CONSTRUCTED IN ACCORDANCE WITH LOCAL CODE REQUIREMENTS AND/OR PROJECT SPECIFICATIONS. THESE COMPONENTS SHOULD BE REVIEWED AND APPROVED BY A LICENSED DESIGN PROFESSIONAL.
3. STANDARD JM SQUARE SPLIT PIPE BOOT SIZES ARE 2" AND 4".

### Maximum Guarantee Term: 20 Year

Johns Manville is a manufacturer of commercial roofing products and offers this general conceptual information to you as a courtesy. This complimentary assistance is not to be used or relied upon by anyone as a substitute for professional engineering design and documentation required by building code, contract, or applicable law. By accepting these comments you agree they do not constitute any representations, endorsements of, or an assumption by Johns Manville of any liability for either the adequacy of design of this building or any other material not supplied by Johns Manville.

**Note:** For the most current information on general guidelines, please refer to the System Considerations tab under Commercial Roofing Products on the JM Roofing Web site. For specifications, flashing details and general installation information please refer to the Application Tools tab.

Refer to the Safe Use Instructions and product label prior to using this product.





## TPO Split Pipe Boot - Square - Clamped

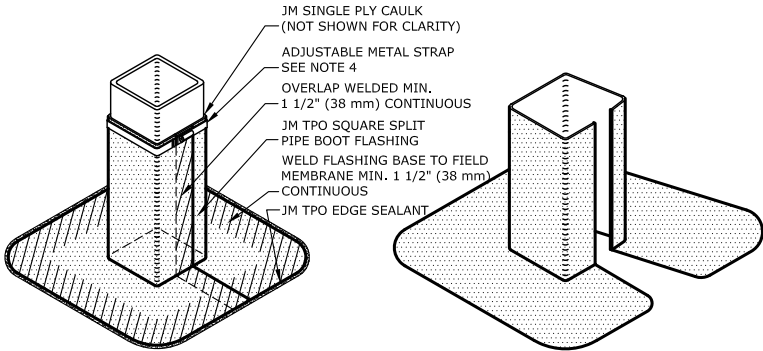

**INSTALLED BOOT  
ISOMETRIC VIEW**

**UNINSTALLED BOOT  
ISOMETRIC VIEW**

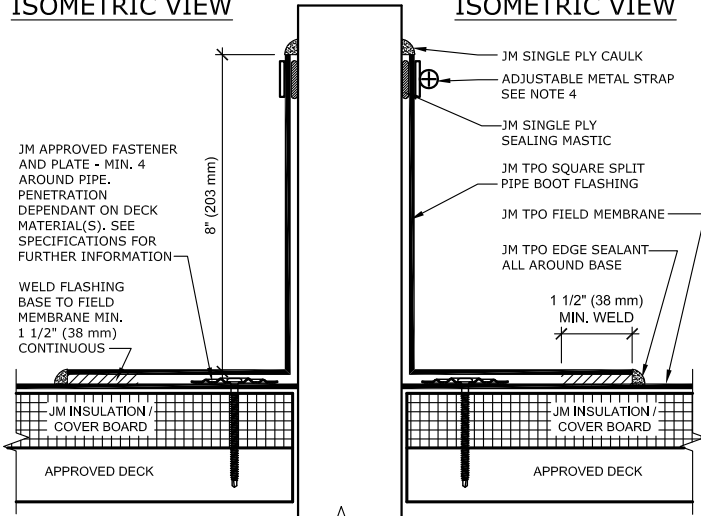

**NOTES:**

1. REFER TO JOHNS MANVILLE WEBSITE ([www.jm.com](http://www.jm.com)) FOR MOST UP-TO-DATE INFORMATION.
2. ANY CARPENTRY OR METAL WORK SHOULD BE DESIGNED AND CONSTRUCTED IN ACCORDANCE WITH LOCAL CODE REQUIREMENTS AND/OR PROJECT SPECIFICATIONS. THESE COMPONENTS SHOULD BE REVIEWED AND APPROVED BY A LICENSED DESIGN PROFESSIONAL.
3. STANDARD JM SQUARE SPLIT PIPE BOOT SIZES ARE 2" AND 4".
4. HOLD CLAMP ADJUSTMENT SCREW AT CENTER OF SIDE OF TUBING, 1/8" DOWN FROM TOP OF FLASHING. TIGHTLY FORM STRAP AROUND 90 DEGREE CORNER AND REPEAT FOR OTHER 3 CORNERS WHILE KEEPING STRAP TIGHT. FEED STRAP END INTO ADJUSTMENT SCREW AND TIGHTEN. ENSURE 1/8" OF FLASHING IS EXPOSED ABOVE STRAP, AND SEALING MASTIC BEHIND FLASHING IS EXPOSED ABOVE FLASHING. CAULK TOP OF FLASHING AROUND ENTIRE PIPE.

### Maximum Guarantee Term: 20 Year

Johns Manville is a manufacturer of commercial roofing products and offers this general conceptual information to you as a courtesy. This complimentary assistance is not to be used or relied upon by anyone as a substitute for professional engineering design and documentation required by building code, contract, or applicable law. By accepting these comments you agree they do not constitute any representations, endorsements of, or an assumption by Johns Manville of any liability for either the adequacy of design of this building or any other material not supplied by Johns Manville.

**Note:** For the most current information on general guidelines, please refer to the System Considerations tab under Commercial Roofing Products on the JM Roofing Web site. For specifications, flashing details and general installation information please refer to the Application Tools tab.

Refer to the Safe Use Instructions and product label prior to using this product.



## Field Fabricated Pipe Penetration

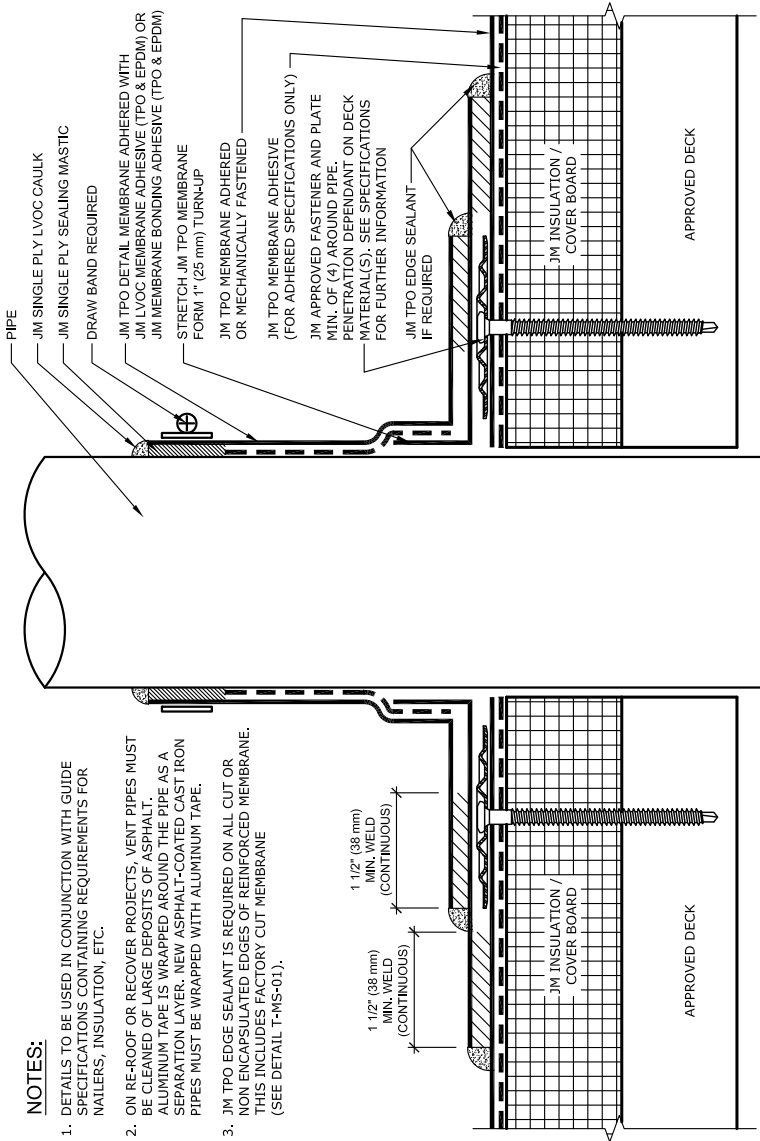

### NOTES:

1. DETAILS TO BE USED IN CONJUNCTION WITH GUIDE SPECIFICATIONS CONTAINING REQUIREMENTS FOR NAILERS, INSULATION, ETC.
2. ON RE-ROOF OR RECOVER PROJECTS, VENT PIPES MUST BE CLEANED OF LARGE DEPOSITS OF ASPHALT. ALUMINUM TAPE IS WRAPPED AROUND THE PIPE AS A SEPARATION LAYER. NEW ASPHALT-COATED CAST IRON PIPES MUST BE WRAPPED WITH ALUMINUM TAPE.
3. JM TPO EDGE SEALANT IS REQUIRED ON ALL CUT OR NON ENCAPSULATED EDGES OF REINFORCED MEMBRANE. THIS INCLUDES FACTORY CUT MEMBRANE (SEE DETAIL T-MS-01).

## Maximum Guarantee Term: 30 Year

Johns Manville is a manufacturer of commercial roofing products and offers this general conceptual information to you as a courtesy. This complimentary assistance is not to be used or relied upon by anyone as a substitute for professional engineering design and documentation required by building code, contract, or applicable law. By accepting these comments you agree they do not constitute any representations, endorsements of, or an assumption by Johns Manville of any liability for either the adequacy of design of this building or any other material not supplied by Johns Manville.

**Note:** For the most current information on general guidelines, please refer to the System Considerations tab under Commercial Roofing Products on the JM Roofing Web site. For specifications, flashing details and general installation information please refer to the Application Tools tab.

Refer to the Safe Use Instructions and product label prior to using this product.



## Transition for Staged Roofing - TPO Coated Metal

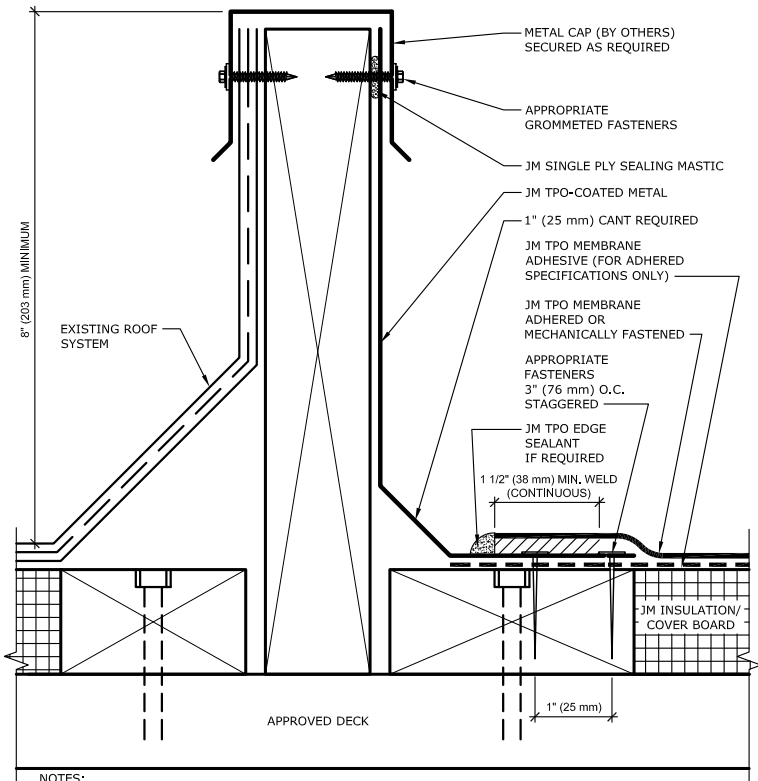

**NOTES:**

1. REFER TO JOHNS MANVILLE WEBSITE ([www.jm.com](http://www.jm.com)) FOR MOST UP-TO-DATE INFORMATION.
2. PLEASE SEE SINGLE PLY FLASHING SPECIFICATIONS FOR A FULL DESCRIPTION OF INSTALLATION INSTRUCTIONS AND REQUIREMENTS WHICH ARE CONSIDERED A PART OF THIS DETAIL.
3. ANY CARPENTRY OR METAL WORK SHOULD BE DESIGNED AND CONSTRUCTED IN ACCORDANCE WITH LOCAL CODE REQUIREMENTS AND/OR PROJECT SPECIFICATIONS. THESE COMPONENTS SHOULD BE REVIEWED AND APPROVED BY A LICENSED DESIGN PROFESSIONAL.
4. JM TPO EDGE SEALANT IS REQUIRED ON ALL CUT OR NON-ENCAPSULATED EDGES OF REINFORCED MEMBRANE. THIS INCLUDES FACTORY CUT MEMBRANE (SEE DETAIL T-MS-01).

### Maximum Guarantee Term: 20 Year

Johns Manville is a manufacturer of commercial roofing products and offers this general conceptual information to you as a courtesy. This complimentary assistance is not to be used or relied upon by anyone as a substitute for professional engineering design and documentation required by building code, contract, or applicable law. By accepting these comments you agree they do not constitute any representations, endorsements of, or an assumption by Johns Manville of any liability for either the adequacy of design of this building or any other material not supplied by Johns Manville.

**Note:** For the most current information on general guidelines, please refer to the System Considerations tab under Commercial Roofing Products on the JM Roofing Web site. For specifications, flashing details and general installation information please refer to the Application Tools tab.

Refer to the Safe Use Instructions and product label prior to using this product.



## Transition to Shingle Roof with TPO Coated Metal

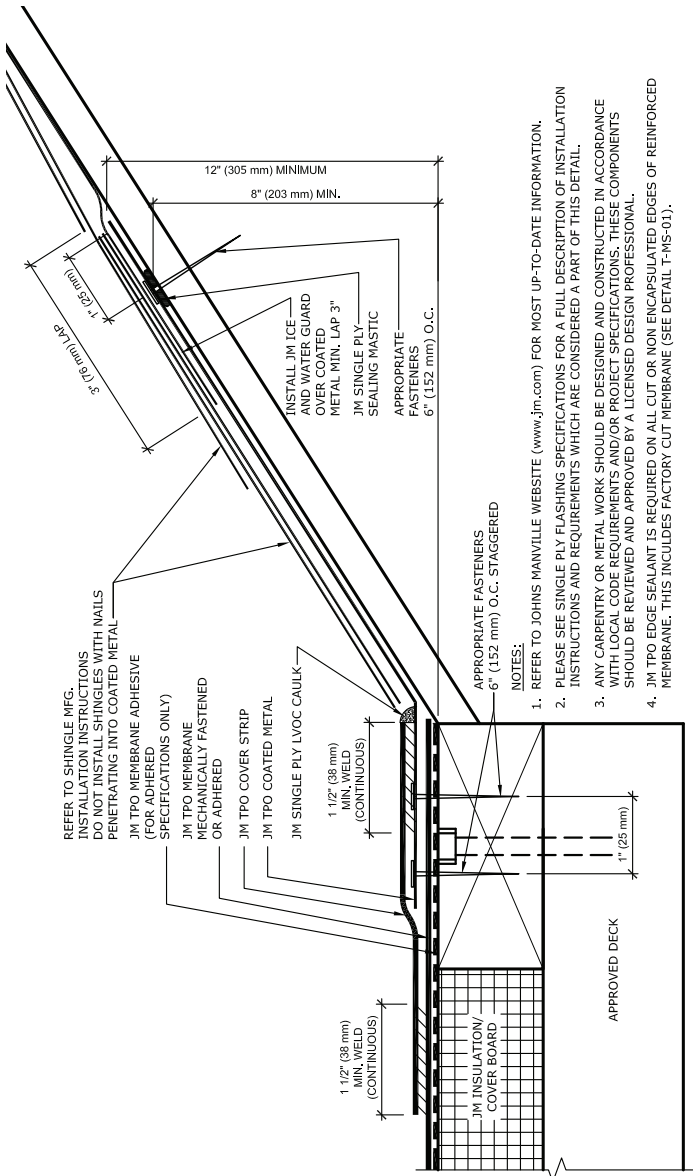

### Maximum Guarantee Term: 20 Year

Johns Manville is a manufacturer of commercial roofing products and offers this general conceptual information to you as a courtesy. This complimentary assistance is not to be used or relied upon by anyone as a substitute for professional engineering design and documentation required by building code, contract, or applicable law. By accepting these comments you agree they do not constitute any representations, endorsements of, or an assumption by Johns Manville of any liability for either the adequacy of design of this building or any other material not supplied by Johns Manville.

**Note:** For the most current information on general guidelines, please refer to the System Considerations tab under Commercial Roofing Products on the JM Roofing Web site. For specifications, flashing details and general installation information please refer to the Application Tools tab.

Refer to the Safe Use Instructions and product label prior to using this product.



## Curb Tie-In To Roof By Others

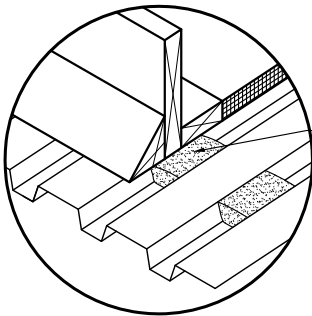

ON STEEL DECKS  
FILL FLUTES WITH  
SPRAY FOAM AT  
LOCATION OF  
CURB TIE-IN

ISOMETRIC VIEW OF  
STEEL DECK INSTALLATION

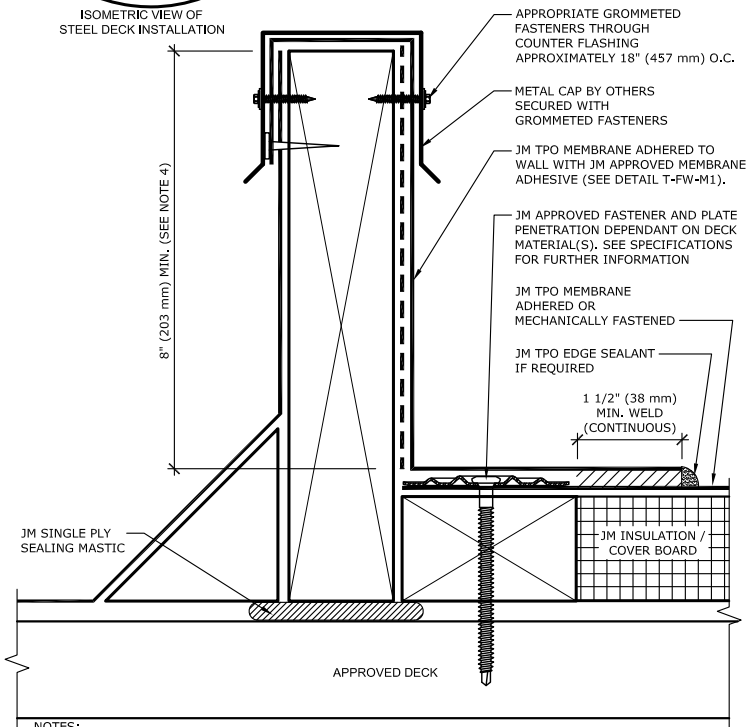

**NOTES:**

1. REFER TO JOHNS MANVILLE WEBSITE ([www.Jm.com](http://www.Jm.com)) FOR MOST UP-TO-DATE INFORMATION.
2. PLEASE SEE SINGLE PLY FLASHING SPECIFICATIONS FOR A FULL DESCRIPTION OF INSTALLATION INSTRUCTIONS AND REQUIREMENTS WHICH ARE CONSIDERED A PART OF THIS DETAIL.
3. ANY CARPENTRY OR METAL WORK SHOULD BE DESIGNED AND CONSTRUCTED IN ACCORDANCE WITH LOCAL CODE REQUIREMENTS AND/OR PROJECT SPECIFICATIONS. THESE COMPONENTS SHOULD BE REVIEWED AND APPROVED BY A LICENSED DESIGN PROFESSIONAL.
4. HEIGHT OF CURB TO BE ADJUSTED WITH NAILERS. IT IS PREFERRED TO RAISE CURB ONTO NAILERS TO EXTEND FLASHING HEIGHT.
5. TPO EDGE SEALANT IS REQUIRED ON ALL CUT AND NON ENCAPSULATED EDGES OF REINFORCED MEMBRANE. THIS INCLUDES FACTORY CUT MEMBRANE (SEE DETAIL T-MS-01).
6. SEE T-FW-B DETAILS FOR JM APPROVED BASE FLASHING TIE IN TERMINATION METHODS.

## Maximum Guarantee Term: 30 Year

Johns Manville is a manufacturer of commercial roofing products and offers this general conceptual information to you as a courtesy. This complimentary assistance is not to be used or relied upon by anyone as a substitute for professional engineering design and documentation required by building code, contract, or applicable law. By accepting these comments you agree they do not constitute any representations, endorsements of, or an assumption by Johns Manville of any liability for either the adequacy of design of this building or any other material not supplied by Johns Manville.

**Note:** For the most current information on general guidelines, please refer to the System Considerations tab under Commercial Roofing Products on the JM Roofing Web site. For specifications, flashing details and general installation information please refer to the Application Tools tab.

Refer to the Safe Use Instructions and product label prior to using this product.



## Expansion Joint - Roof to Wall

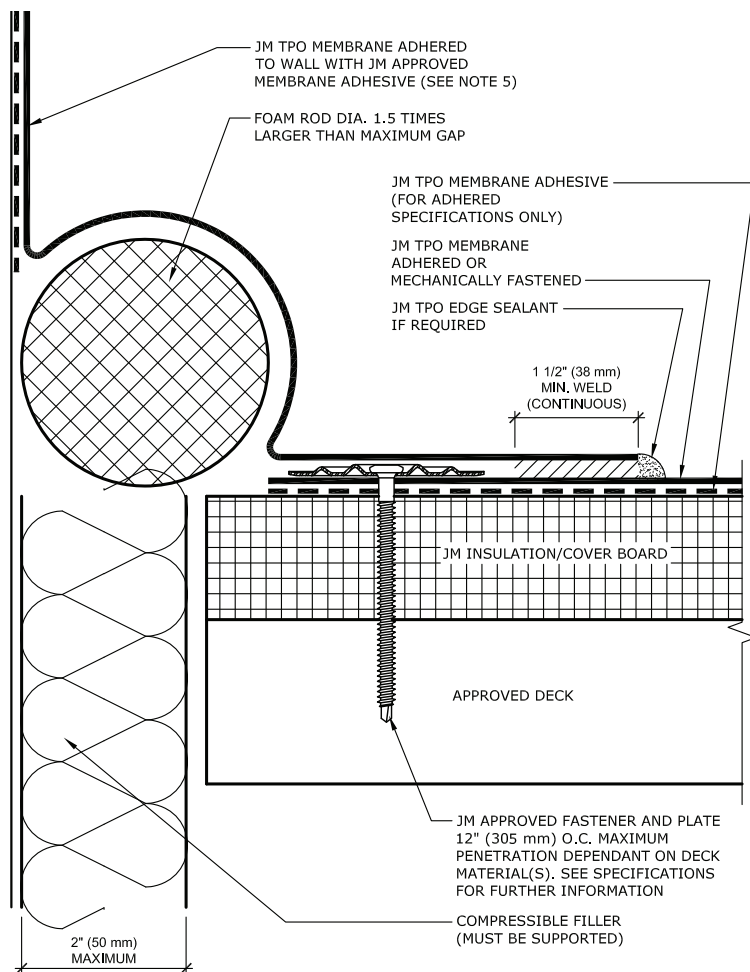

### NOTES:

1. REFER TO JOHNS MANVILLE WEBSITE ([www.jm.com](http://www.jm.com)) FOR MOST UP-TO-DATE INFORMATION.
2. PLEASE SEE SINGLE PLY FLASHING SPECIFICATIONS FOR A FULL DESCRIPTION OF INSTALLATION INSTRUCTIONS AND REQUIREMENTS WHICH ARE CONSIDERED A PART OF THIS DETAIL.
3. ANY CARPENTRY OR METAL WORK SHOULD BE DESIGNED AND CONSTRUCTED IN ACCORDANCE WITH LOCAL CODE REQUIREMENTS AND/OR PROJECT SPECIFICATIONS. THESE COMPONENTS SHOULD BE REVIEWED AND APPROVED BY A LICENSED DESIGN PROFESSIONAL.
4. JM TPO EDGE SEALANT IS REQUIRED ON ALL CUT OR NON ENCAPSULATED EDGES OF REINFORCED MEMBRANE. THIS INCLUDES FACTORY CUT MEMBRANE (SEE DETAIL T-MS-01).
5. JM APPROVED ADHESIVES FOR USE ON VERTICAL FLASHING APPLICATIONS INCLUDES JM LVOC MEMBRANE ADHESIVE (TPO & EPDM OR JM MEMBRANE BONDING ADHESIVE (TPO & EPDM)).

## Maximum Guarantee Term: 30 Year

Johns Manville is a manufacturer of commercial roofing products and offers this general conceptual information to you as a courtesy. This complimentary assistance is not to be used or relied upon by anyone as a substitute for professional engineering design and documentation required by building code, contract, or applicable law. By accepting these comments you agree they do not constitute any representations, endorsements of, or an assumption by Johns Manville of any liability for either the adequacy of design of this building or any other material not supplied by Johns Manville.

**Note:** For the most current information on general guidelines, please refer to the System Considerations tab under Commercial Roofing Products on the JM Roofing Web site. For specifications, flashing details and general installation information please refer to the Application Tools tab.

Refer to the Safe Use Instructions and product label prior to using this product.





## Expand-O-Flash Roof to Roof Expansion Joint Cover - Style EJ

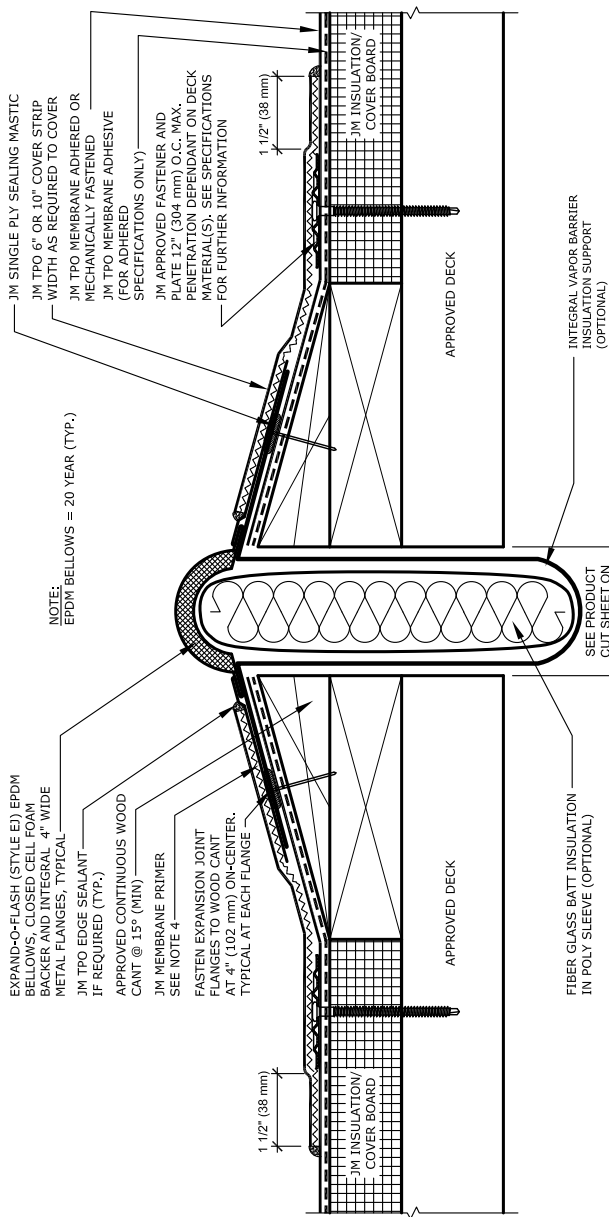

- NOTES:**
1. REFER TO JOHNS MANVILLE WEBSITE ([www.jm.com](http://www.jm.com)) FOR MOST UP-TO-DATE INFORMATION AND INSTALLATION INSTRUCTIONS.
  2. PLEASE SEE SINGLE PLY FLASHING SPECIFICATIONS FOR A FULL DESCRIPTION OF INSTALLATION INSTRUCTIONS AND REQUIREMENTS WHICH ARE CONSIDERED A PART OF THIS DETAIL.
  3. ANY CARPENTRY OR METAL WORK SHOULD BE DESIGNED AND CONSTRUCTED IN ACCORDANCE WITH LOCAL CODE REQUIREMENTS AND/OR PROJECT SPECIFICATIONS. THESE COMPONENTS SHOULD BE REVIEWED AND APPROVED BY A LICENSED DESIGN PROFESSIONAL.
  4. JM TPO MEMBRANE PRIMER OR JM SINGLE PLY MEMBRANE PRIMER (LOW VOC) MUST BE APPLIED TO ALL SURFACES COMING INTO CONTACT WITH JM TPO COVER TAPE. ROLL TAPE WITH HAND ROLLER UNDER PRESSURE.

### Maximum Guarantee Term: 20 Year

Johns Manville is a manufacturer of commercial roofing products and offers this general conceptual information to you as a courtesy. This complimentary assistance is not to be used or relied upon by anyone as a substitute for professional engineering design and documentation required by building code, contract, or applicable law. By accepting these comments you agree they do not constitute any representations, endorsements of, or an assumption by Johns Manville of any liability for either the adequacy of design of this building or any other material not supplied by Johns Manville.

**Note:** For the most current information on general guidelines, please refer to the System Considerations tab under Commercial Roofing Products on the JM Roofing Web site. For specifications, flashing details and general installation information please refer to the Application Tools tab.

Refer to the Safe Use Instructions and product label prior to using this product.





## Expand-O-Flash Roof to Wall - Style EJ

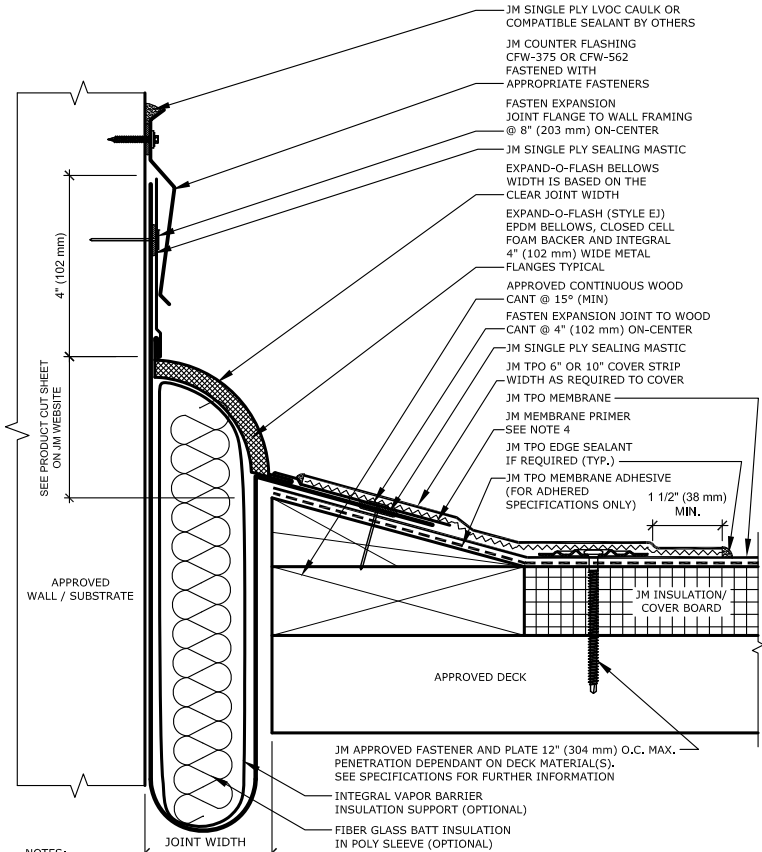

**NOTES:**

1. REFER TO JOHNS MANVILLE WEBSITE ([www.jm.com](http://www.jm.com)) FOR MOST UP-TO-DATE INFORMATION AND INSTALLATION INSTRUCTIONS.
2. PLEASE SEE SINGLE PLY FLASHING SPECIFICATIONS FOR A FULL DESCRIPTION OF INSTALLATION INSTRUCTIONS AND REQUIREMENTS WHICH ARE CONSIDERED A PART OF THIS DETAIL.
3. ANY CARPENTRY OR METAL WORK SHOULD BE DESIGNED AND CONSTRUCTED IN ACCORDANCE WITH LOCAL CODE REQUIREMENTS AND/OR PROJECT SPECIFICATIONS. THESE COMPONENTS SHOULD BE REVIEWED AND APPROVED BY A LICENSED DESIGN PROFESSIONAL.
4. JM TPO MEMBRANE PRIMER OR JM SINGLE PLY MEMBRANE PRIMER (LOW VOC) MUST BE APPLIED TO ALL SURFACES COMING INTO CONTACT WITH JM TPO COVER TAPE. ROLL TAPE WITH HAND ROLLER UNDER PRESSURE.

### Maximum Guarantee Term: 20 Year

Johns Manville is a manufacturer of commercial roofing products and offers this general conceptual information to you as a courtesy. This complimentary assistance is not to be used or relied upon by anyone as a substitute for professional engineering design and documentation required by building code, contract, or applicable law. By accepting these comments you agree they do not constitute any representations, endorsements of, or an assumption by Johns Manville of any liability for either the adequacy of design of this building or any other material not supplied by Johns Manville.

**Note:** For the most current information on general guidelines, please refer to the System Considerations tab under Commercial Roofing Products on the JM Roofing Web site. For specifications, flashing details and general installation information please refer to the Application Tools tab.

Refer to the Safe Use Instructions and product label prior to using this product.



## Expand-O-Flash Curb to Curb Expansion Joint Cover - Style CF

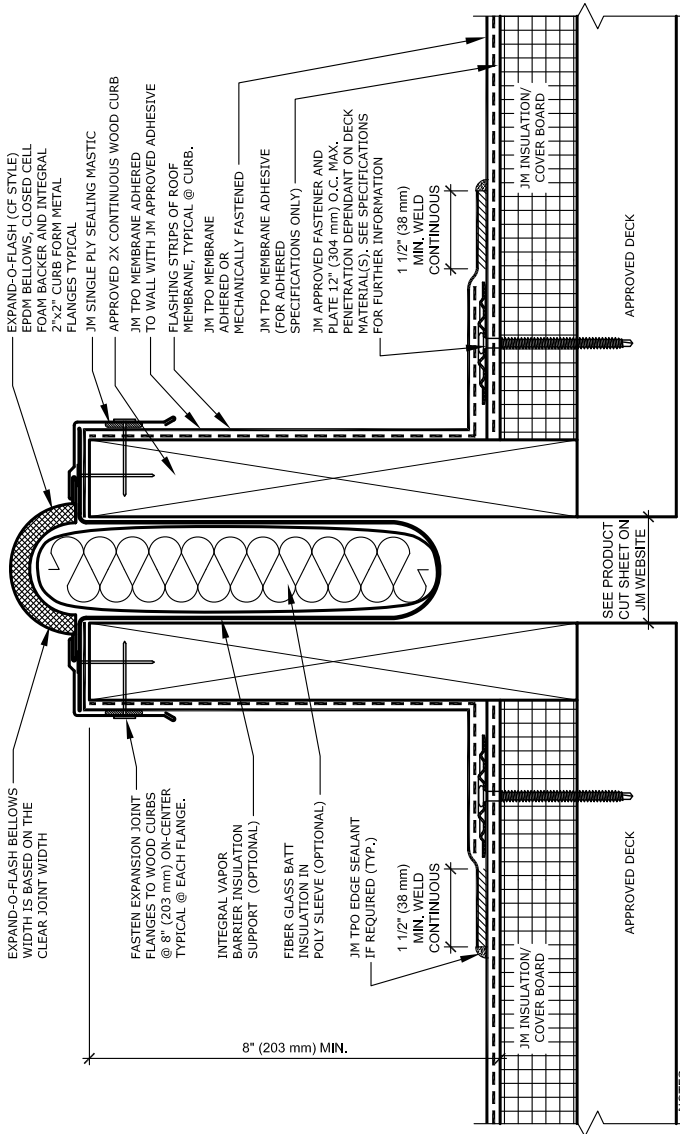

- NOTES:
1. REFER TO JOHNS MANVILLE WEBSITE ([www.jm.com](http://www.jm.com)) FOR MOST UP-TO-DATE INFORMATION AND INSTALLATION INSTRUCTIONS.
  2. PLEASE SEE SINGLE PLY FLASHING SPECIFICATIONS FOR A FULL DESCRIPTION OF INSTALLATION INSTRUCTIONS AND REQUIREMENTS WHICH ARE CONSIDERED A PART OF THIS DETAIL.
  3. ANY CARPENTRY OR METAL WORK SHOULD BE DESIGNED AND CONSTRUCTED IN ACCORDANCE WITH LOCAL CODE REQUIREMENTS AND/OR PROJECT SPECIFICATIONS. THESE COMPONENTS SHOULD BE REVIEWED AND APPROVED BY A LICENSED DESIGN PROFESSIONAL.

### Maximum Guarantee Term: 20 Year

Johns Manville is a manufacturer of commercial roofing products and offers this general conceptual information to you as a courtesy. This complimentary assistance is not to be used or relied upon by anyone as a substitute for professional engineering design and documentation required by building code, contract, or applicable law. By accepting these comments you agree they do not constitute any representations, endorsements of, or an assumption by Johns Manville of any liability for either the adequacy of design of this building or any other material not supplied by Johns Manville.

**Note:** For the most current information on general guidelines, please refer to the System Considerations tab under Commercial Roofing Products on the JM Roofing Web site. For specifications, flashing details and general installation information refer to the Application Tools tab.

Refer to the Safe Use Instructions and product label prior to using this product.



## Expand-O-Flash Curb to Wall Expansion Joint Cover - Style CF/EJ

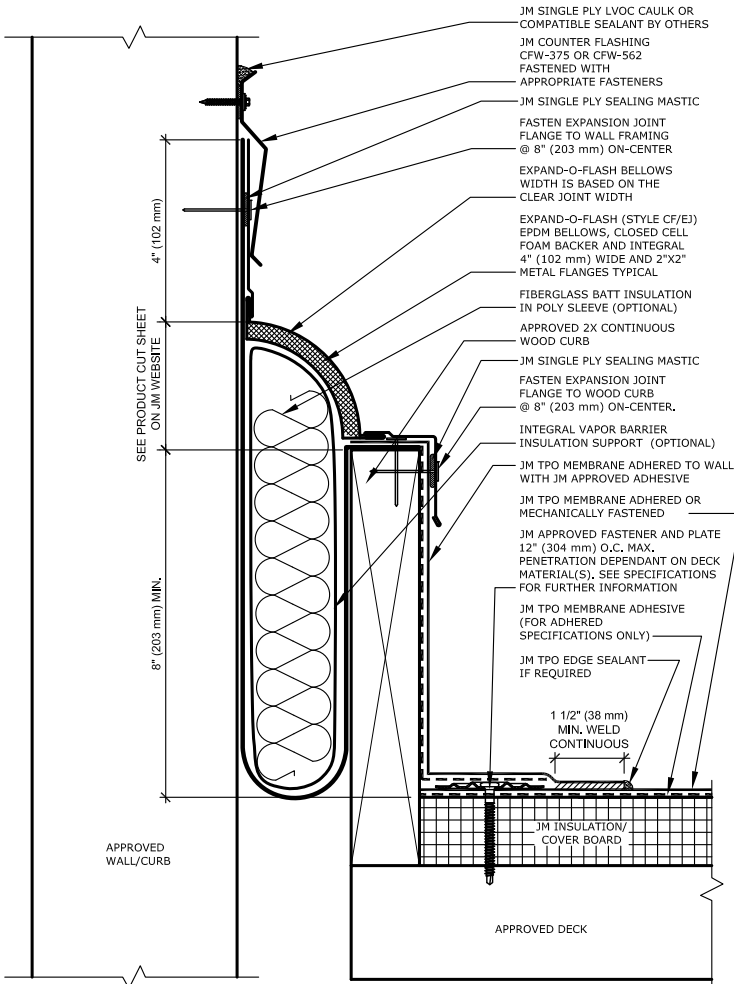

**NOTES:**

1. REFER TO JOHNS MANVILLE WEBSITE ([www.jm.com](http://www.jm.com)) FOR MOST UP-TO-DATE INFORMATION AND INSTALLATION INSTRUCTIONS.
2. PLEASE SEE SINGLE PLY FLASHING SPECIFICATIONS FOR A FULL DESCRIPTION OF INSTALLATION INSTRUCTIONS AND REQUIREMENTS WHICH ARE CONSIDERED A PART OF THIS DETAIL.
3. ANY CARPENTRY OR METAL WORK SHOULD BE DESIGNED AND CONSTRUCTED IN ACCORDANCE WITH LOCAL CODE REQUIREMENTS AND/OR PROJECT SPECIFICATIONS. THESE COMPONENTS SHOULD BE REVIEWED AND APPROVED BY A LICENSED DESIGN PROFESSIONAL.

### Maximum Guarantee Term: 20 Year

Johns Manville is a manufacturer of commercial roofing products and offers this general conceptual information to you as a courtesy. This complimentary assistance is not to be used or relied upon by anyone as a substitute for professional engineering design and documentation required by building code, contract, or applicable law. By accepting these comments you agree they do not constitute any representations, endorsements of, or an assumption by Johns Manville of any liability for either the adequacy of design of this building or any other material not supplied by Johns Manville.

**Note:** For the most current information on general guidelines, please refer to the System Considerations tab under Commercial Roofing Products on the JM Roofing Web site. For specifications, flashing details and general installation information please refer to the Application Tools tab.

Refer to the Safe Use Instructions and product label prior to using this product.



## JM Vapor Barrier SA - Wall Base Detail

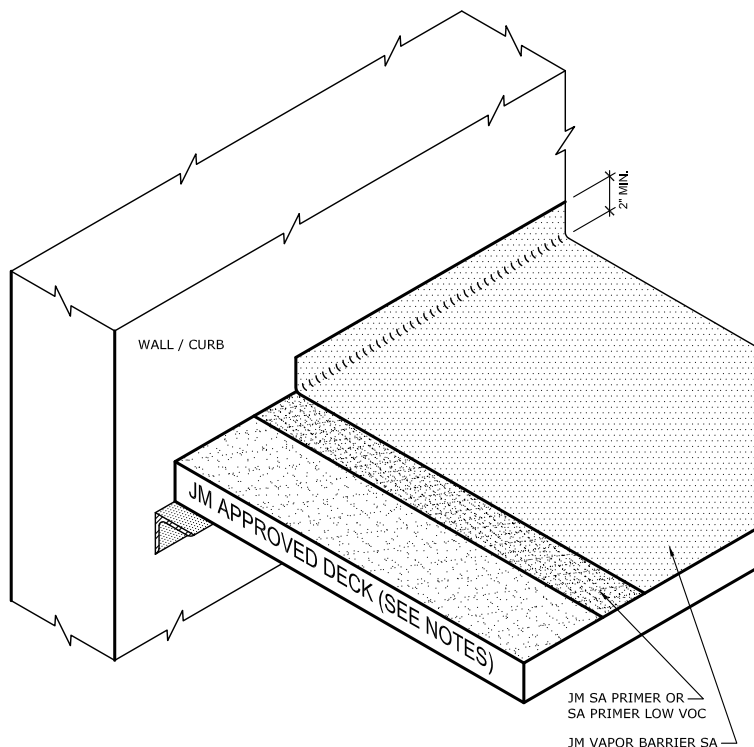

### NOTES

1. USE DETAIL IN CONJUNCTION WITH THE STANDARD CURB DETAIL FOR APPROVED ROOF SYSTEM.
2. REFER TO JM VAPOR BARRIER AND PRIMER INSTALLATION INSTRUCTIONS FOR GENERAL GUIDELINES REGARDING THESE SYSTEMS.
3. FOR STEEL DECK SYSTEMS IT IS REQUIRED TO HAVE A MINIMUM OF 1/2" THERMAL BARRIER FASTENED TO STEEL DECK BEFORE JM VAPOR BARRIER IS ADHERED.

Johns Manville is a manufacturer of commercial roofing products and offers this general conceptual information to you as a courtesy. This complimentary assistance is not to be used or relied upon by anyone as a substitute for professional engineering design and documentation required by building code, contract, or applicable law. By accepting these comments you agree they do not constitute any representations, endorsements of, or an assumption by Johns Manville of any liability for either the adequacy of design of this building or any other material not supplied by Johns Manville.

**Note:** For the most current information on general guidelines, please refer to the System Considerations tab under Commercial Roofing Products on the JM Roofing Web site. For specifications, flashing details and general installation information please refer to the Application Tools tab.

Refer to the Safe Use Instructions and product label prior to using this product.



## JM Vapor Barrier SA - Wall Base Detail (ALT)

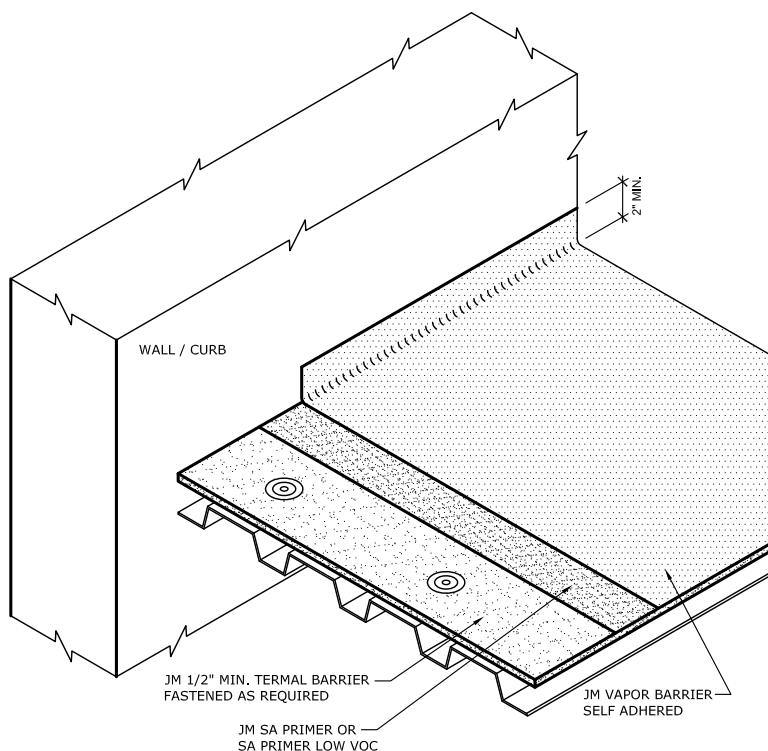

### NOTES

1. USE DETAIL IN CONJUNCTION WITH THE STANDARD CURB DETAIL FOR APPROVED ROOF SYSTEM.
2. REFER TO JM VAPOR BARRIER AND PRIMER INSTALLATION INSTRUCTIONS FOR GENERAL GUIDELINES REGARDING THESE SYSTEMS.
3. FOR STEEL DECK SYSTEMS IT IS REQUIRED TO HAVE A MINIMUM OF 1/2" THERMAL BARRIER FASTENED TO STEEL DECK BEFORE JM VAPOR BARRIER IS ADHERED.

Johns Manville is a manufacturer of commercial roofing products and offers this general conceptual information to you as a courtesy. This complimentary assistance is not to be used or relied upon by anyone as a substitute for professional engineering design and documentation required by building code, contract, or applicable law. By accepting these comments you agree they do not constitute any representations, endorsements of, or an assumption by Johns Manville of any liability for either the adequacy of design of this building or any other material not supplied by Johns Manville.

**Note:** For the most current information on general guidelines, please refer to the System Considerations tab under Commercial Roofing Products on the JM Roofing Web site. For specifications, flashing details and general installation information please refer to the Application Tools tab.

Refer to the Safe Use Instructions and product label prior to using this product.



## JM Vapor Barrier SA - Pipe Penetration Detail

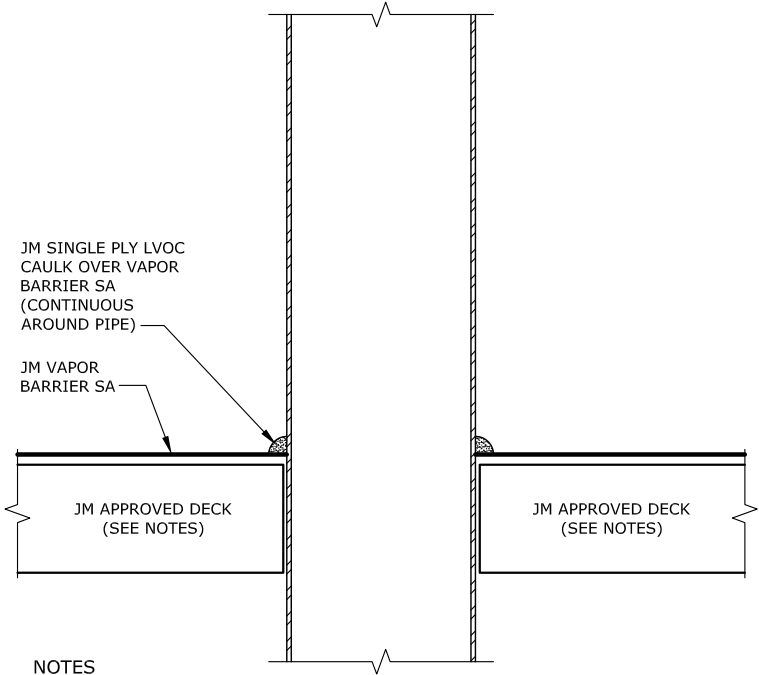

### NOTES

1. USE DETAIL IN CONJUNCTION WITH THE STANDARD CURB DETAIL FOR APPROVED ROOF SYSTEM.
2. REFER TO JM VAPOR BARRIER AND PRIMER INSTALLATION INSTRUCTIONS FOR GENERAL GUIDELINES REGARDING THESE SYSTEMS.
3. FOR STEEL DECK SYSTEMS IT IS REQUIRED TO HAVE A MINIMUM OF 1/2" THERMAL BARRIER FASTENED TO STEEL DECK BEFORE JM VAPOR BARRIER IS ADHERED.

Johns Manville is a manufacturer of commercial roofing products and offers this general conceptual information to you as a courtesy. This complimentary assistance is not to be used or relied upon by anyone as a substitute for professional engineering design and documentation required by building code, contract, or applicable law. By accepting these comments you agree they do not constitute any representations, endorsements of, or an assumption by Johns Manville of any liability for either the adequacy of design of this building or any other material not supplied by Johns Manville.

**Note:** For the most current information on general guidelines, please refer to the System Considerations tab under Commercial Roofing Products on the JM Roofing Web site. For specifications, flashing details and general installation information please refer to the Application Tools tab.

Refer to the Safe Use Instructions and product label prior to using this product.



## JM Vapor Barrier SA - Drain Detail

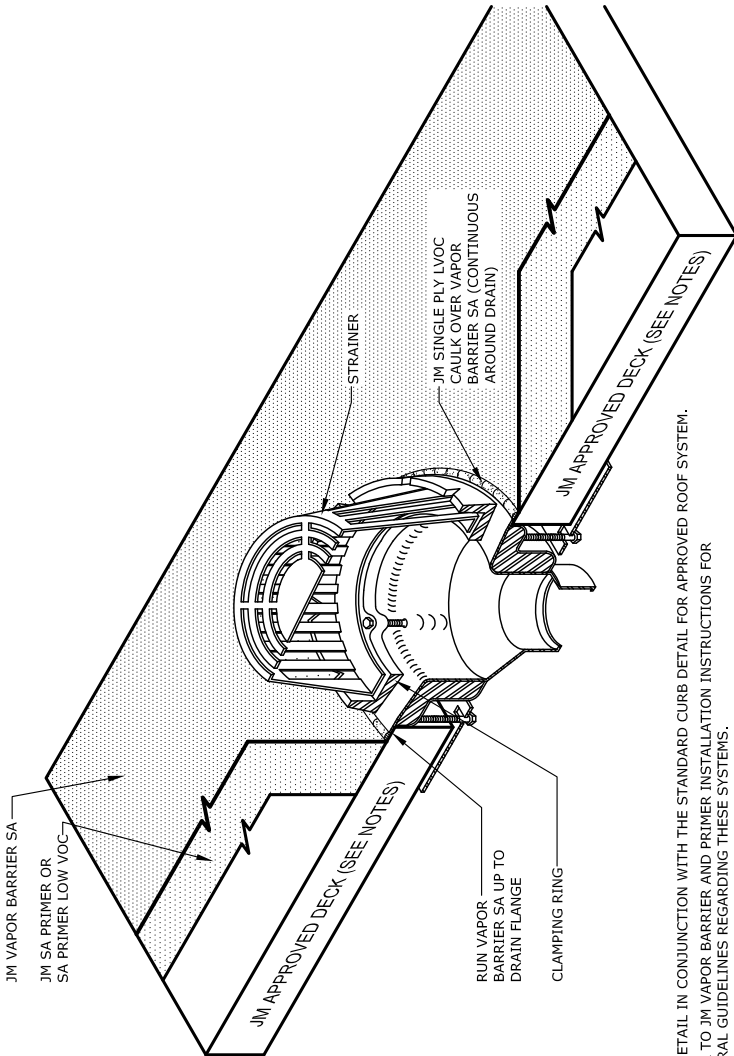

**NOTES**

1. USE DETAIL IN CONJUNCTION WITH THE STANDARD CURB DETAIL FOR APPROVED ROOF SYSTEM.
2. REFER TO JM VAPOR BARRIER AND PRIMER INSTALLATION INSTRUCTIONS FOR GENERAL GUIDELINES REGARDING THESE SYSTEMS.
3. FOR STEEL DECK SYSTEMS IT IS REQUIRED TO HAVE A MINIMUM OF 1/2" THERMAL BARRIER FASTENED TO STEEL DECK BEFORE JM VAPOR BARRIER IS ADHERED.

Johns Manville is a manufacturer of commercial roofing products and offers this general conceptual information to you as a courtesy. This complimentary assistance is not to be used or relied upon by anyone as a substitute for professional engineering design and documentation required by building code, contract, or applicable law. By accepting these comments you agree they do not constitute any representations, endorsements of, or an assumption by Johns Manville of any liability for either the adequacy of design of this building or any other material not supplied by Johns Manville.

**Note:** For the most current information on general guidelines, please refer to the System Considerations tab under Commercial Roofing Products on the JM Roofing Web site. For specifications, flashing details and general installation information please refer to the Application Tools tab.

Refer to the Safe Use Instructions and product label prior to using this product.



## JM Vapor Barrier SA - Detail at Field Laps

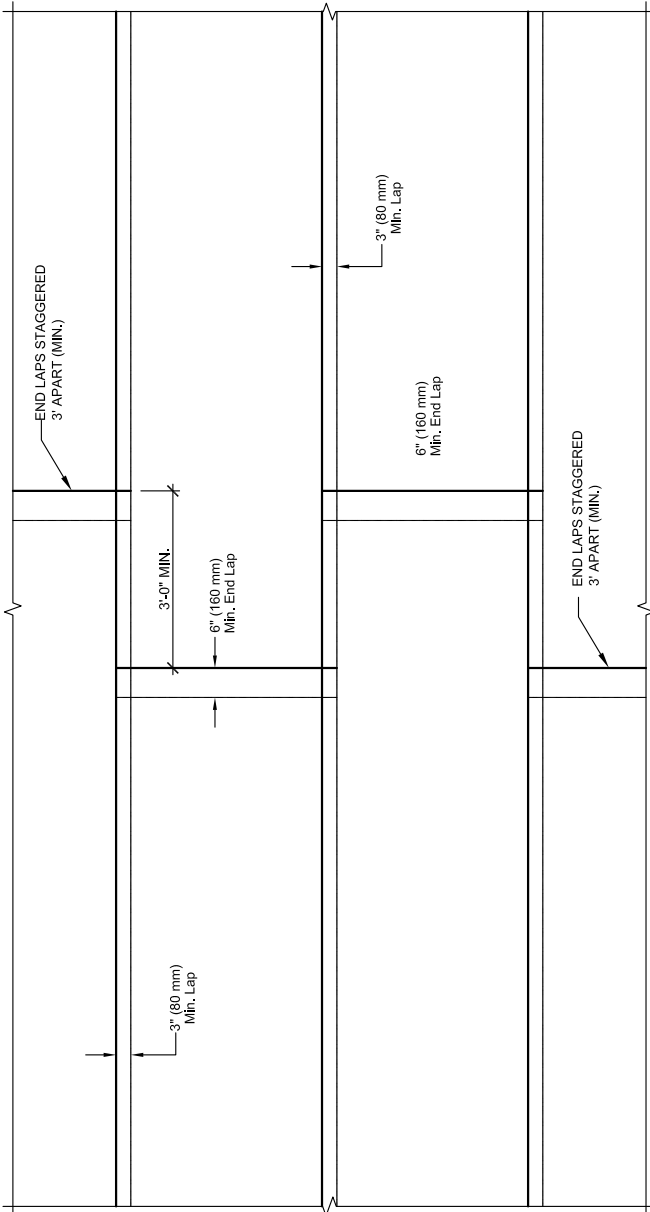

Johns Manville is a manufacturer of commercial roofing products and offers this general conceptual information to you as a courtesy. This complimentary assistance is not to be used or relied upon by anyone as a substitute for professional engineering design and documentation required by building code, contract, or applicable law. By accepting these comments you agree they do not constitute any representations, endorsements of, or an assumption by Johns Manville of any liability for either the adequacy of design of this building or any other material not supplied by Johns Manville.

**Note:** For the most current information on general guidelines, please refer to the System Considerations tab under Commercial Roofing Products on the JM Roofing Web site. For specifications, flashing details and general installation information please refer to the Application Tools tab.

Refer to the Safe Use Instructions and product label prior to using this product.





## JM Vapor Barrier SA - Outside Curb Detail

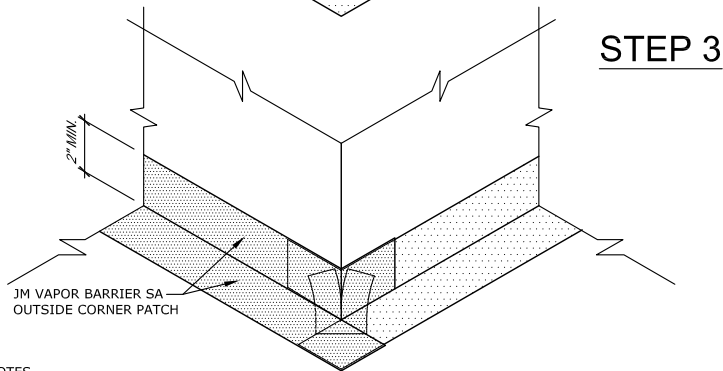
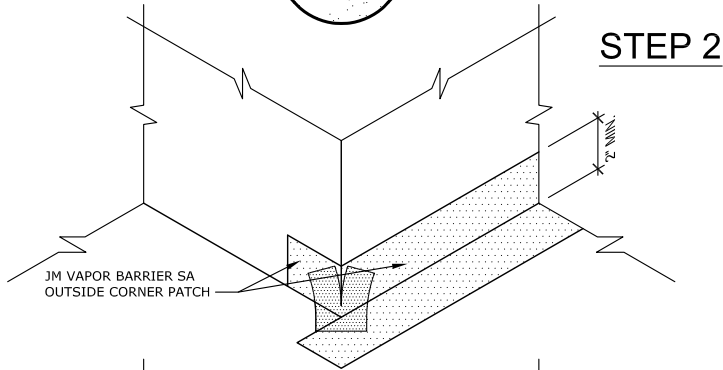
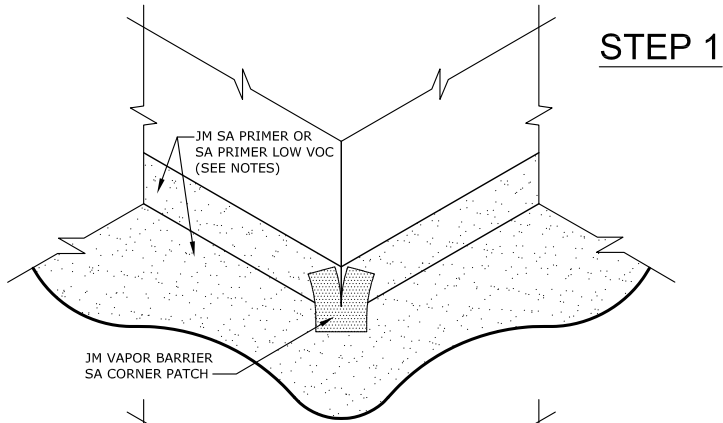

**NOTES**

1. USE DETAIL IN CONJUNCTION WITH THE STANDARD CURB DETAIL FOR APPROVED ROOF SYSTEM.
2. REFER TO JM VAPOR BARRIER AND PRIMER INSTALLATION INSTRUCTIONS FOR GENERAL GUIDELINES REGARDING THESE SYSTEMS.
3. FOR STEEL DECK SYSTEMS IT IS REQUIRED TO HAVE A MINIMUM OF 1/2" THERMAL BARRIER FASTENED TO STEEL DECK BEFORE JM VAPOR BARRIER IS ADHERED.

Johns Manville is a manufacturer of commercial roofing products and offers this general conceptual information to you as a courtesy. This complimentary assistance is not to be used or relied upon by anyone as a substitute for professional engineering design and documentation required by building code, contract, or applicable law. By accepting these comments you agree they do not constitute any representations, endorsements of, or an assumption by Johns Manville of any liability for either the adequacy of design of this building or any other material not supplied by Johns Manville.

**Note:** For the most current information on general guidelines, please refer to the System Considerations tab under Commercial Roofing Products on the JM Roofing Web site. For specifications, flashing details and general installation information please refer to the Application Tools tab.

Refer to the Safe Use Instructions and product label prior to using this product.



## JM Vapor Barrier SA - Inside Curb Detail

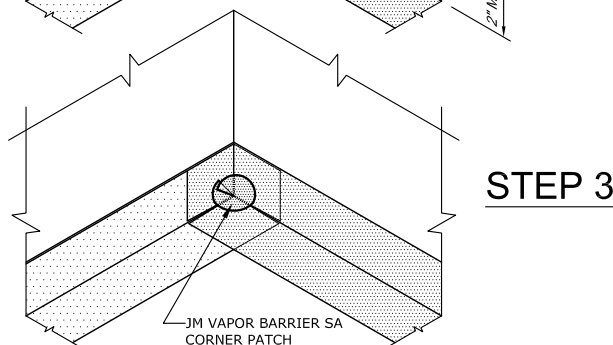
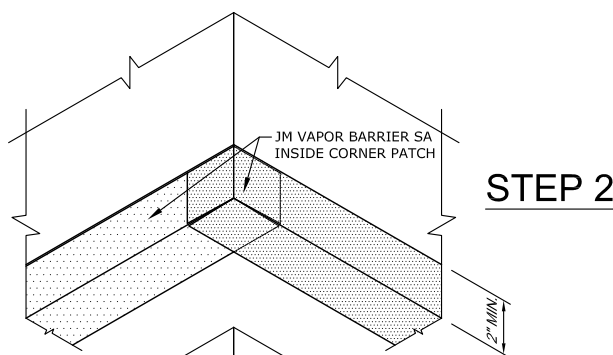
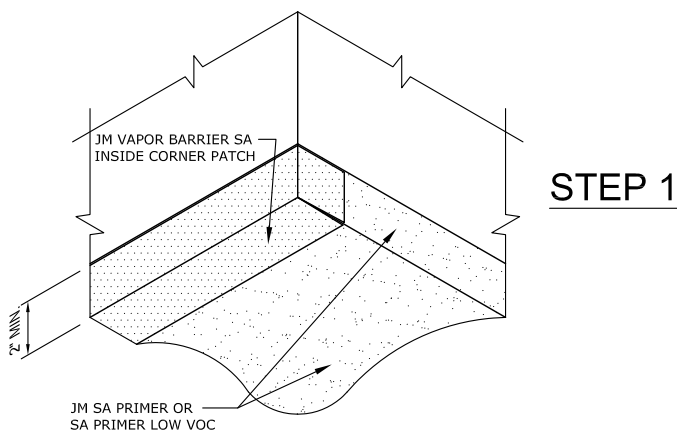

**NOTES**

1. USE DETAIL IN CONJUNCTION WITH THE STANDARD CURB DETAIL FOR APPROVED ROOF SYSTEM.
2. REFER TO JM VAPOR BARRIER AND PRIMER INSTALLATION INSTRUCTIONS FOR GENERAL GUIDELINES REGARDING THESE SYSTEMS.
3. FOR STEEL DECK SYSTEMS IT IS REQUIRED TO HAVE A MINIMUM OF 1/2" THERMAL BARRIER FASTENED TO STEEL DECK BEFORE JM VAPOR BARRIER IS ADHERED.

Johns Manville is a manufacturer of commercial roofing products and offers this general conceptual information to you as a courtesy. This complimentary assistance is not to be used or relied upon by anyone as a substitute for professional engineering design and documentation required by building code, contract, or applicable law. By accepting these comments you agree they do not constitute any representations, endorsements of, or an assumption by Johns Manville of any liability for either the adequacy of design of this building or any other material not supplied by Johns Manville.

**Note:** For the most current information on general guidelines, please refer to the System Considerations tab under Commercial Roofing Products on the JM Roofing Web site. For specifications, flashing details and general installation information please refer to the Application Tools tab.

Refer to the Safe Use Instructions and product label prior to using this product.



## TPO Hybrid Base & Wall Flashing with Coping Master Detail

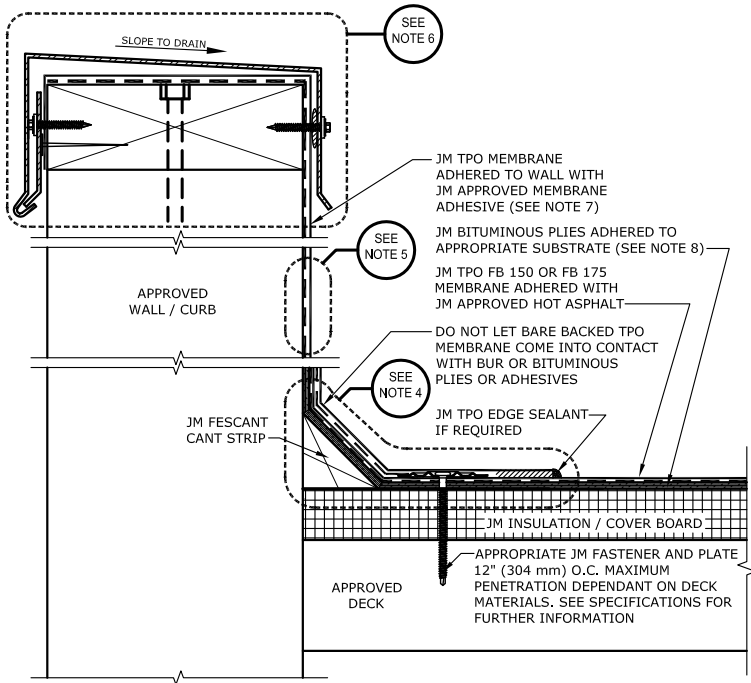

### NOTES:

1. REFER TO JOHNS MANVILLE WEBSITE ([www.jm.com](http://www.jm.com)) FOR MOST UP-TO-DATE INFORMATION.
2. PLEASE SEE SINGLE PLY FLASHING SPECIFICATIONS FOR A FULL DESCRIPTION OF INSTALLATION INSTRUCTIONS AND REQUIREMENTS WHICH ARE CONSIDERED A PART OF THIS DETAIL.
3. ANY CARPENTRY OR METAL WORK SHOULD BE DESIGNED AND CONSTRUCTED IN ACCORDANCE WITH LOCAL CODE REQUIREMENTS AND/OR PROJECT SPECS. THESE COMPONENTS SHOULD BE REVIEWED AND APPROVED BY A LICENSED DESIGN PROFESSIONAL.
4. FOR JM APPROVED BASE FLASHING FASTENING METHODS SEE TH-FW-B DETAILS. A SUFFICIENT BACKER FASTENING STRIP MUST BE INSTALLED BEHIND SUBSTRATES DIRECTLY TO STUDS FOR INSTALLATION OF TERMINATION BARS AND FLASHINGS WHEN SUBSTRATES WILL NOT SUPPORT A PROPER, SECURE INSTALLATION. SEE DETAIL TH-FW-M2I FOR BACKER DETAIL.
5. FOR JM APPROVED INTERMEDIATE FLASHING FASTENING METHODS SEE T-FW-I DETAILS. MINIMUM FLASHING TERMINATION HEIGHT IS 8" ABOVE ROOF SURFACE. INTERMEDIATE ADHERED MEMBRANE FASTENING REQUIRED AT 5'-0" INTERVALS MAXIMUM, AND 18" HIGH MAXIMUM FOR NON ADHERED MEMBRANE ON CMU, BRICK, SMOOTH CONCRETE WALLS, OR ANY JM APPROVED SUBSTRATE, IE. PLYWOOD, GLASS FACED GYPSUM OR JM INVINSA. SEE DETAIL TH-FW-M2I FOR JM APPROVED FASTENING METHODS.
6. FOR JM APPROVED TOP OF WALL FLASHING METHODS SEE T-FW-T DETAILS.
7. JM APPROVED ADHESIVES FOR USE ON VERTICAL FLASHING APPLICATIONS INCLUDES JM LVOC MEMBRANE ADHESIVE (TPO & EPDM), JM MEMBRANE BONDING ADHESIVE (TPO & EPDM), AND TPO WATER BASED MEMBRANE ADHESIVE.
8. BITUMINOUS PLIES INCLUDE APPROPRIATE SMOOTH JM SBS MODIFIED BITUMEN SHEETS APPLIED WITH HOT ASPHALT, MBR COLD APPLICATION ADHESIVE, OR HEAT WELDING TECHNIQUES AND/OR PLY FELTS APPLIED IN HOT ASPHALT.
9. JM APPROVED ADHESIVES FOR JM TPO FLEECE BACKED MEMBRANE ADHERED OVER BITUMINOUS PLIES INCLUDES HOT ASPHALT.
10. JM TPO EDGE SEALANT IS REQUIRED ON ALL CUT OR NON-ENCAPSULATED EDGES OF REINFORCED MEMBRANE. THIS INCLUDES FACTORY CUT MEMBRANE. SEE DETAIL T-MS-01.

Johns Manville is a manufacturer of commercial roofing products and offers this general conceptual information to you as a courtesy. This complimentary assistance is not to be used or relied upon by anyone as a substitute for professional engineering design and documentation required by building code, contract, or applicable law. By accepting these comments you agree they do not constitute any representations, endorsements of, or an assumption by Johns Manville of any liability for either the adequacy of design of this building or any other material not supplied by Johns Manville.

**Note:** For the most current information on general guidelines, please refer to the System Considerations tab under Commercial Roofing Products on the JM Roofing Web site. For specifications, flashing details and general installation information please refer to the Application Tools tab.

Refer to the Safe Use Instructions and product label prior to using this product.



## TPO Hybrid Base & Wall Flashing with Coping Isometric View Master

**NOTES:**

1. REFER TO JOHNS MANVILLE WEBSITE ([www.jm.com](http://www.jm.com)) FOR MOST UP-TO-DATE INFORMATION.
2. PLEASE SEE TPO SYSTEM FLASHING SPECIFICATIONS FOR A FULL DESCRIPTION OF INSTALLATION INSTRUCTIONS AND REQUIREMENTS WHICH ARE CONSIDERED A PART OF THIS DETAIL.
3. ANY CARPENTRY OR METAL WORK SHOULD BE DESIGNED AND CONSTRUCTED IN ACCORDANCE WITH LOCAL CODE REQUIREMENTS AND/OR PROJECT SPECIFICATIONS. THESE COMPONENTS SHOULD BE REVIEWED AND APPROVED BY A LICENSED DESIGN PROFESSIONAL.
4. JM TPO EDGE SEALANT IS REQUIRED ON ALL CUT OR NON-ENCAPSULATED EDGES OF REINFORCED MEMBRANE. THIS INCLUDES FACTORY CUT MEMBRANE. SEE DETAIL T-MS-01
5. FOR JM APPROVED BASE FLASHING FASTENING METHODS SEE TH-FW-B DETAILS. A SUFFICIENT BACKER FASTENING STRIP MUST BE INSTALLED BEHIND SUBSTRATES DIRECTLY TO STUDS FOR INSTALLATION OF TERMINATION BARS AND FLASHINGS WHEN SUBSTRATES WILL NOT SUPPORT A PROPER, SECURE INSTALLATION. SEE DETAIL TH-FW-M2I FOR BACKER DETAIL.

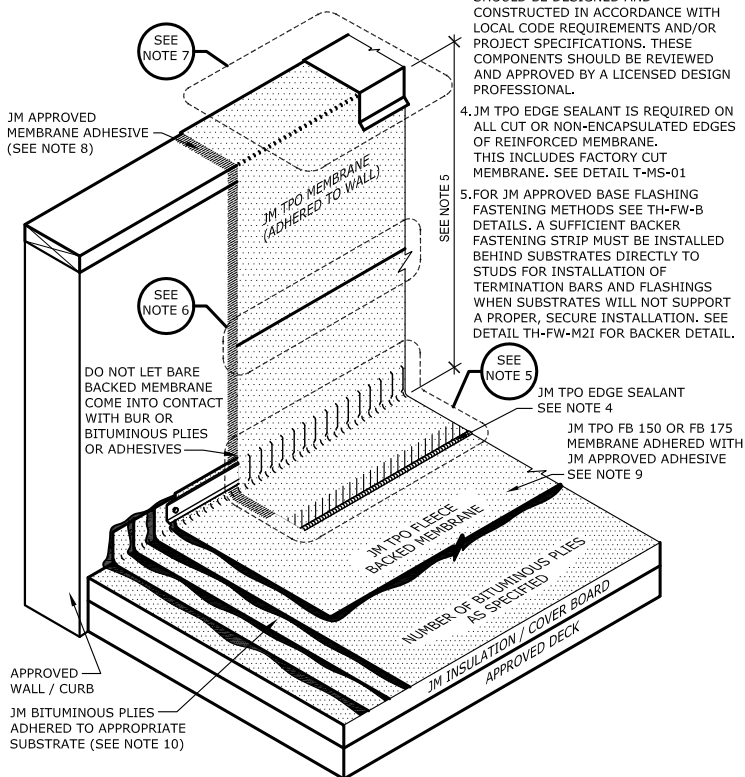

**NOTES CONTINUED:**

6. FOR JM APPROVED INTERMEDIATE FLASHING FASTENING METHODS SEE T-FW-I DETAILS. MINIMUM FLASHING TERMINATION HEIGHT IS 8" ABOVE ROOF SURFACE. INTERMEDIATE ADHERED MEMBRANE FASTENING REQUIRED AT 5'-0" INTERVALS MAXIMUM, AND 18" HIGH MAXIMUM FOR NON ADHERED MEMBRANE ON CMU, BRICK, SMOOTH CONCRETE WALLS, OR ANY JM APPROVED SUBSTRATE, I.E. PLYWOOD, GLASS FACED GYPSUM OR JM INVINSA. SEE DETAIL TH-FW-M2I FOR JM APPROVED FASTENING METHODS.
7. FOR JM APPROVED TOP OF WALL FLASHING METHODS SEE T-FW-T DETAILS.
8. JM APPROVED ADHESIVES FOR USE ON VERTICAL FLASHING APPLICATIONS INCLUDES JM TPO MEMBRANE ADHESIVES (LOW VOC ONLY).
9. JM APPROVED ADHESIVES FOR JM TPO FLEECE BACKED MEMBRANE ADHERED OVER BITUMINOUS PLIES INCLUDES HOT ASPHALT.
10. JM BITUMINOUS PLIES INCLUDE APPROPRIATE SMOOTH SBS MODIFIED BITUMEN SHEETS APPLIED WITH HOT ASPHALT, MBR COLD APPLICATION ADHESIVE, OR HEAT WELDED TECHNIQUES, AND/OR PLY FELTS APPLIED IN HOT ASPHALT.

Johns Manville is a manufacturer of commercial roofing products and offers this general conceptual information to you as a courtesy. This complimentary assistance is not to be used or relied upon by anyone as a substitute for professional engineering design and documentation required by building code, contract, or applicable law. By accepting these comments you agree they do not constitute any representations, endorsements of, or an assumption by Johns Manville of any liability for either the adequacy of design of this building or any other material not supplied by Johns Manville.

**Note:** For the most current information on general guidelines, please refer to the System Considerations tab under Commercial Roofing Products on the JM Roofing Web site. For specifications, flashing details and general installation information please refer to the Application Tools tab.

Refer to the Safe Use Instructions and product label prior to using this product.



## Highwall Flashing with Metal Backing Strip Isometric View Master

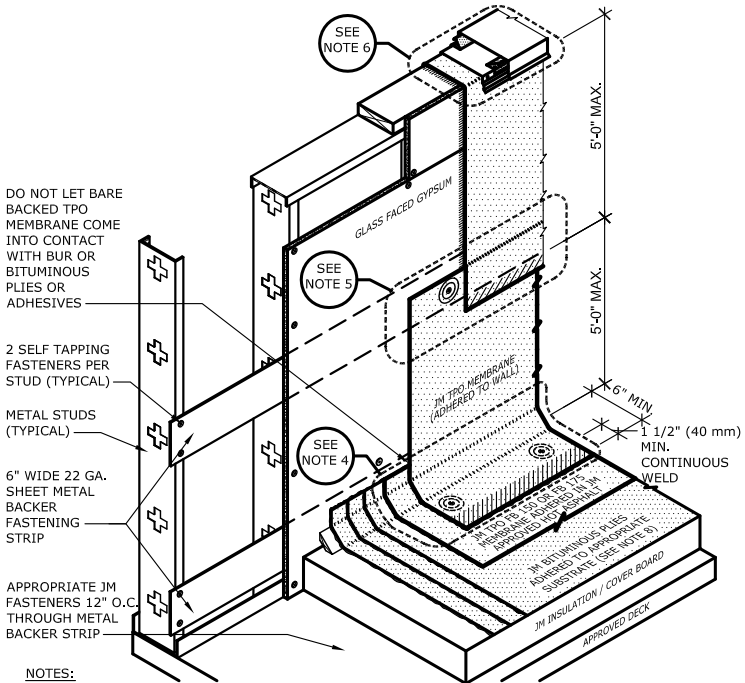

DO NOT LET BARE BACKED TPO MEMBRANE COME INTO CONTACT WITH BUR OR BITUMINOUS PLIES OR ADHESIVES

2 SELF TAPPING FASTENERS PER STUD (TYPICAL)

METAL STUDS (TYPICAL)

6" WIDE 22 GA. SHEET METAL BACKER FASTENING STRIP

APPROPRIATE JM FASTENERS 12" O.C. THROUGH METAL BACKER STRIP

**NOTES:**

1. REFER TO JOHNS MANVILLE WEBSITE ([www.jm.com](http://www.jm.com)) FOR MOST UP-TO-DATE INFORMATION.
2. PLEASE SEE SINGLE PLY FLASHING SPECIFICATIONS FOR A FULL DESCRIPTION OF INSTALLATION INSTRUCTIONS AND REQUIREMENTS WHICH ARE CONSIDERED A PART OF THIS DETAIL.
3. ANY CARPENTRY OR METAL WORK SHOULD BE DESIGNED AND CONSTRUCTED IN ACCORDANCE WITH LOCAL CODE REQUIREMENTS AND/OR PROJECT SPECS. THESE COMPONENTS SHOULD BE REVIEWED AND APPROVED BY A LICENSED DESIGN PROFESSIONAL.
4. FOR JM APPROVED BASE FLASHING FASTENING METHODS SEE TH-FW-B DETAILS. A SUFFICIENT BACKER FASTENING STRIP MUST BE INSTALLED BEHIND SUBSTRATES DIRECTLY TO STUDS FOR INSTALLATION OF TERMINATION BARS AND FLASHINGS WHEN SUBSTRATES WILL NOT SUPPORT A PROPER, SECURE INSTALLATION. SEE DETAIL TH-FW-M2I FOR BACKER DETAIL.
5. FOR JM APPROVED INTERMEDIATE FLASHING FASTENING METHODS SEE T-FW-I DETAILS. MINIMUM FLASHING TERMINATION HEIGHT IS 8" ABOVE ROOF SURFACE. INTERMEDIATE ADHERED MEMBRANE FASTENING REQUIRED AT 5'-0" INTERVALS MAXIMUM, AND 18" HIGH MAXIMUM FOR NON ADHERED MEMBRANE ON CMU, BRICK, SMOOTH CONCRETE WALLS, OR ANY JM APPROVED SUBSTRATE, IE. PLYWOOD, GLASS FACED GYPSUM OR JM INVINSA. SEE DETAIL TH-FW-M2I FOR JM APPROVED FASTENING METHODS.
6. FOR JM APPROVED TOP OF WALL FLASHING METHODS SEE T-FW-T DETAILS.
7. JM APPROVED ADHESIVES FOR USE ON VERTICAL FLASHING APPLICATIONS INCLUDES JM LVOC MEMBRANE ADHESIVE (TPO & EPDM), JM MEMBRANE BONDING ADHESIVE (TPO & EPDM) AND TPO WATER BASED MEMBRANE ADHESIVE.
8. JM BITUMINOUS PLIES INCLUDE APPROPRIATE SMOOTH SBS MODIFIED BITUMEN SHEETS APPLIED WITH HOT ASPHALT, MBR COLD APPLICATION ADHESIVE, OR HEAT WELDED TECHNIQUES, AND/OR PLY FELTS APPLIED IN HOT ASPHALT.
9. JM APPROVED ADHESIVES FOR JM TPO FLEECE BACKED MEMBRANE SHEET OVER BITUMINOUS PLIES INCLUDE HOT ASPHALT.
10. JM TPO EDGE SEALANT IS REQUIRED ON ALL CUT OR NON-ENCAPSULATED EDGES OF REINFORCED MEMBRANE. THIS INCLUDES FACTORY CUT MEMBRANE. SEE DETAIL T-MS-01.

**Maximum Guarantee Term: 30 Years**

Johns Manville is a manufacturer of commercial roofing products and offers this general conceptual information to you as a courtesy. This complimentary assistance is not to be used or relied upon by anyone as a substitute for professional engineering design and documentation required by building code, contract, or applicable law. By accepting these comments you agree they do not constitute any representations, endorsements of, or an assumption by Johns Manville of any liability for either the adequacy of design of this building or any other material not supplied by Johns Manville.

**Note:** For the most current information on general guidelines, please refer to the System Considerations tab under Commercial Roofing Products on the JM Roofing Web site. For specifications, flashing details and general installation information please refer to the Application Tools tab.

Refer to the Safe Use Instructions and product label prior to using this product.



## Base Tie-In with Termination Bar

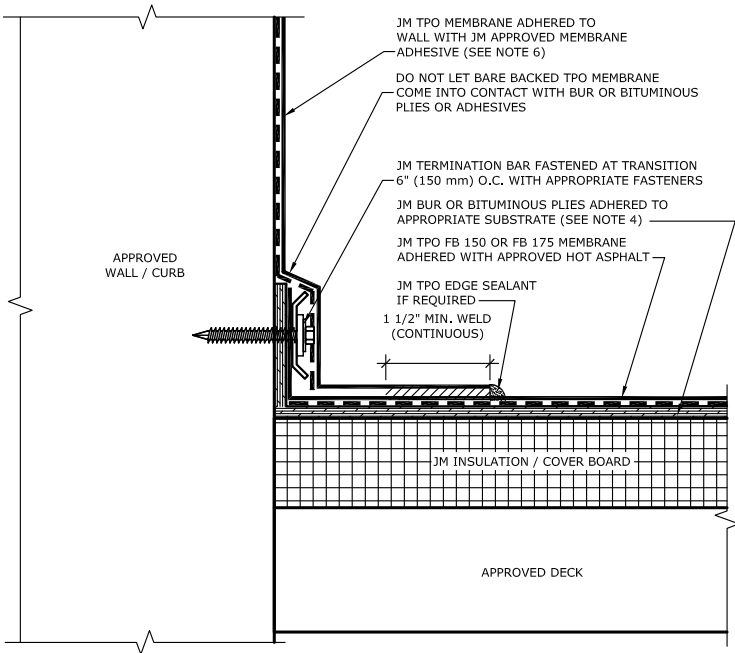

### NOTES:

1. REFER TO JOHNS MANVILLE WEBSITE ([www.jm.com](http://www.jm.com)) FOR MOST UP-TO-DATE INFORMATION.
2. PLEASE SEE SINGLE PLY FLASHING SPECIFICATIONS FOR A FULL DESCRIPTION OF INSTALLATION INSTRUCTIONS AND REQUIREMENTS WHICH ARE CONSIDERED A PART OF THIS DETAIL.
3. ANY CARPENTRY OR METAL WORK SHOULD BE DESIGNED AND CONSTRUCTED IN ACCORDANCE WITH LOCAL CODE REQUIREMENTS AND/OR PROJECT SPECIFICATIONS. THESE COMPONENTS SHOULD BE REVIEWED AND APPROVED BY A LICENSED DESIGN PROFESSIONAL.
4. BITUMINOUS PLYS INCLUDE APPROPRIATE SMOOTH JM SBS MODIFIED BITUMEN SHEETS APPLIED WITH HOT ASPHALT, MBR COLD APPLICATION ADHESIVE, OR HEAT WELDING TECHNIQUES AND/OR PLY FELTS APPLIED IN HOT ASPHALT.
5. JM TPO EDGE SEALANT IS REQUIRED ON ALL CUT OR NON-ENCAPSULATED EDGES OF REINFORCED MEMBRANE. THIS INCLUDES FACTORY CUT MEMBRANE. SEE DETAIL T-MS-01.
6. JM APPROVED ADHESIVES FOR USE ON VERTICAL FLASHING APPLICATIONS INCLUDES JM LVOC MEMBRANE ADHESIVE (TPO & EPDM), JM MEMBRANE BONDING ADHESIVE (TPO & EPDM) AND TPO WATER BASED MEMBRANE ADHESIVE.
7. JM APPROVED ADHESIVES FOR JM TPO FLEECE BACKED MEMBRANE ADHERED OVER BITUMINOUS PLYS INCLUDE HOT ASPHALT.

## Maximum Guarantee Term: 30 Years

Johns Manville is a manufacturer of commercial roofing products and offers this general conceptual information to you as a courtesy. This complimentary assistance is not to be used or relied upon by anyone as a substitute for professional engineering design and documentation required by building code, contract, or applicable law. By accepting these comments you agree they do not constitute any representations, endorsements of, or an assumption by Johns Manville of any liability for either the adequacy of design of this building or any other material not supplied by Johns Manville.

**Note:** For the most current information on general guidelines, please refer to the System Considerations tab under Commercial Roofing Products on the JM Roofing Web site. For specifications, flashing details and general installation information please refer to the Application Tools tab.

Refer to the Safe Use Instructions and product label prior to using this product.



## Base Tie-In Fastener & Plate with Cant

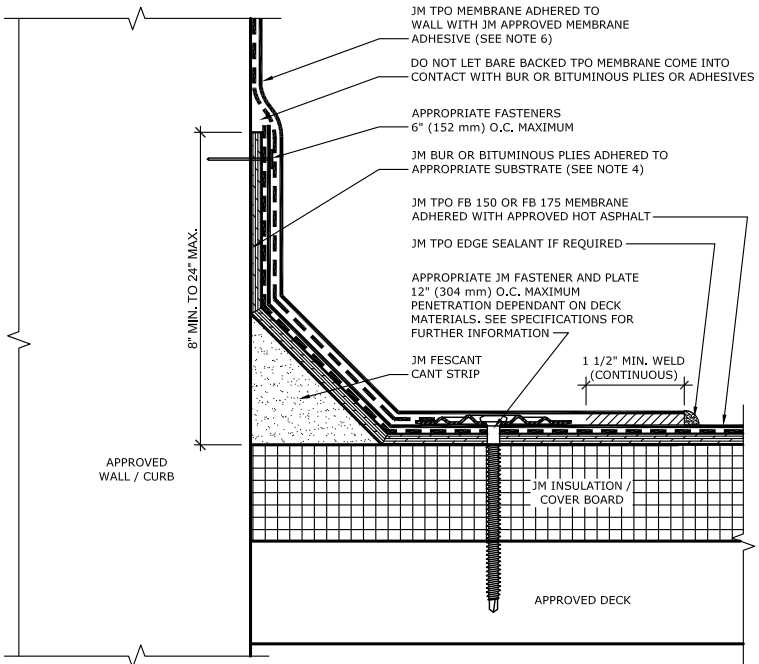

**NOTES:**

1. REFER TO JOHNS MANVILLE WEBSITE ([www.jm.com](http://www.jm.com)) FOR MOST UP-TO-DATE INFORMATION.
2. PLEASE SEE SINGLE PLY FLASHING SPECIFICATIONS FOR A FULL DESCRIPTION OF INSTALLATION INSTRUCTIONS AND REQUIREMENTS WHICH ARE CONSIDERED A PART OF THIS DETAIL.
3. ANY CARPENTRY OR METAL WORK SHOULD BE DESIGNED AND CONSTRUCTED IN ACCORDANCE WITH LOCAL CODE REQUIREMENTS AND/OR PROJECT SPECIFICATIONS. THESE COMPONENTS SHOULD BE REVIEWED AND APPROVED BY A LICENSED DESIGN PROFESSIONAL.
4. BITUMINOUS PLIES INCLUDE APPROPRIATE SMOOTH JM SBS MODIFIED BITUMEN SHEETS APPLIED WITH HOT ASPHALT, MBR COLD APPLICATION ADHESIVE, OR HEAT WELDING TECHNIQUES AND/OR PLY FELTS APPLIED IN HOT ASPHALT.
5. JM TPO EDGE SEALANT IS REQUIRED ON ALL CUT OR NON-ENCAPSULATED EDGES OF REINFORCED MEMBRANE. THIS INCLUDES FACTORY CUT MEMBRANE. SEE DETAIL T-MS-01.
6. JM APPROVED ADHESIVES FOR USE ON VERTICAL FLASHING APPLICATIONS INCLUDES JM LVOC MEMBRANE ADHESIVE (TPO & EPDM), JM MEMBRANE BONDING ADHESIVE (TPO & EPDM) AND TPO WATER BASED MEMBRANE ADHESIVE.
7. JM APPROVED ADHESIVES FOR JM TPO FLEECE BACKED MEMBRANE ADHERED OVER BITUMINOUS PLIES INCLUDE HOT ASPHALT.

## Maximum Guarantee Term: 30 Years

Johns Manville is a manufacturer of commercial roofing products and offers this general conceptual information to you as a courtesy. This complimentary assistance is not to be used or relied upon by anyone as a substitute for professional engineering design and documentation required by building code, contract, or applicable law. By accepting these comments you agree they do not constitute any representations, endorsements of, or an assumption by Johns Manville of any liability for either the adequacy of design of this building or any other material not supplied by Johns Manville.

**Note:** For the most current information on general guidelines, please refer to the System Considerations tab under Commercial Roofing Products on the JM Roofing Web site. For specifications, flashing details and general installation information please refer to the Application Tools tab.

Refer to the Safe Use Instructions and product label prior to using this product.



## Base Tie-In Fastener & Plate on Wall

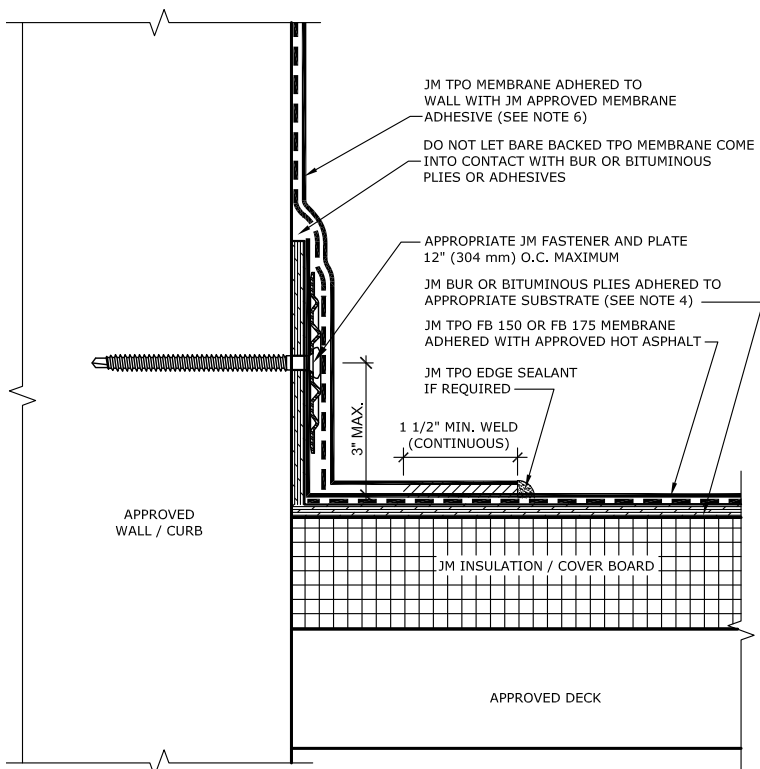

### NOTES:

1. REFER TO JOHNS MANVILLE WEBSITE ([www.jm.com](http://www.jm.com)) FOR MOST UP-TO-DATE INFORMATION.
2. PLEASE SEE SINGLE PLY FLASHING SPECIFICATIONS FOR A FULL DESCRIPTION OF INSTALLATION INSTRUCTIONS AND REQUIREMENTS WHICH ARE CONSIDERED A PART OF THIS DETAIL.
3. ANY CARPENTRY OR METAL WORK SHOULD BE DESIGNED AND CONSTRUCTED IN ACCORDANCE WITH LOCAL CODE REQUIREMENTS AND/OR PROJECT SPECIFICATIONS. THESE COMPONENTS SHOULD BE REVIEWED AND APPROVED BY A LICENSED DESIGN PROFESSIONAL.
4. BITUMINOUS PLIES INCLUDE APPROPRIATE SMOOTH JM SBS MODIFIED BITUMEN SHEETS APPLIED WITH HOT ASPHALT, MBR COLD APPLICATION ADHESIVE, OR HEAT WELDING TECHNIQUES AND/OR PLY FELTS APPLIED IN HOT ASPHALT.
5. JM TPO EDGE SEALANT IS REQUIRED ON ALL CUT OR NON-ENCAPSULATED EDGES OF REINFORCED MEMBRANE. THIS INCLUDES FACTORY CUT MEMBRANE. SEE DETAIL T-MS-01.
6. JM APPROVED ADHESIVES FOR USE ON VERTICAL FLASHING APPLICATIONS INCLUDES JM LVOC MEMBRANE ADHESIVE (TPO & EPDM), JM MEMBRANE BONDING ADHESIVE (TPO & EPDM) AND TPO WATER BASED MEMBRANE ADHESIVE.
7. JM APPROVED ADHESIVES FOR JM TPO FLEECE BACKED MEMBRANE ADHERED OVER BITUMINOUS PLIES INCLUDE HOT ASPHALT.

## Maximum Guarantee Term: 30 Years

Johns Manville is a manufacturer of commercial roofing products and offers this general conceptual information to you as a courtesy. This complimentary assistance is not to be used or relied upon by anyone as a substitute for professional engineering design and documentation required by building code, contract, or applicable law. By accepting these comments you agree they do not constitute any representations, endorsements of, or an assumption by Johns Manville of any liability for either the adequacy of design of this building or any other material not supplied by Johns Manville.

**Note:** For the most current information on general guidelines, please refer to the System Considerations tab under Commercial Roofing Products on the JM Roofing Web site. For specifications, flashing details and general installation information please refer to the Application Tools tab.

Refer to the Safe Use Instructions and product label prior to using this product.







## TPO Fleece Backed Membrane Butted End Lap

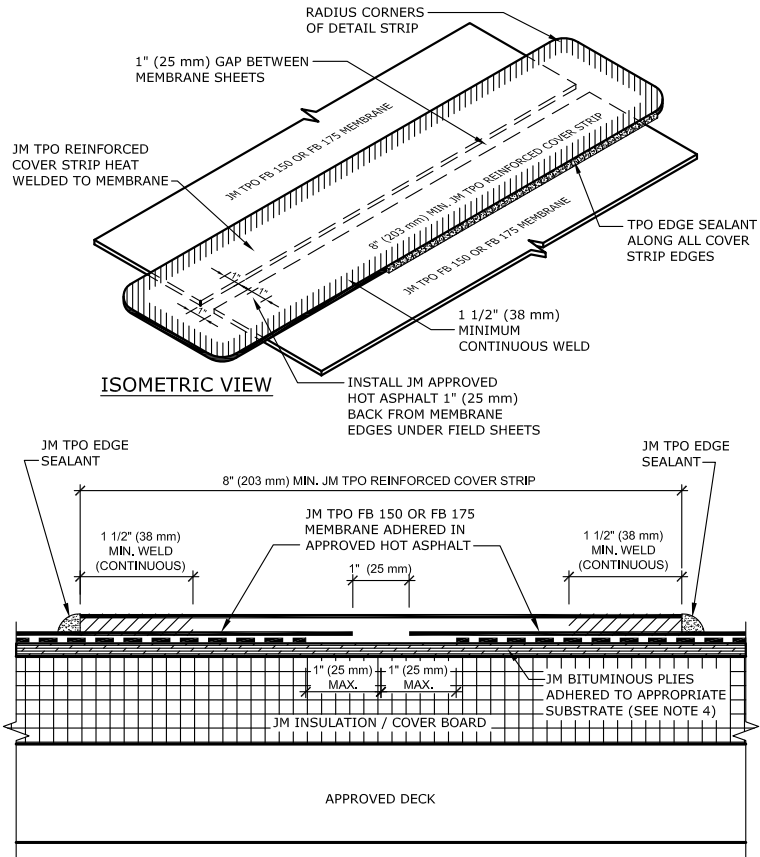

### NOTES:

1. REFER TO JOHNS MANVILLE WEBSITE ([www.jm.com](http://www.jm.com)) FOR MOST UP-TO-DATE INFORMATION.
2. PLEASE SEE SINGLE PLY FLASHING SPECIFICATIONS FOR A FULL DESCRIPTION OF INSTALLATION INSTRUCTIONS AND REQUIREMENTS WHICH ARE CONSIDERED A PART OF THIS DETAIL.
3. ANY CARPENTRY OR METAL WORK SHOULD BE DESIGNED AND CONSTRUCTED IN ACCORDANCE WITH LOCAL CODE REQUIREMENTS AND/OR PROJECT SPECIFICATIONS. THESE COMPONENTS SHOULD BE REVIEWED AND APPROVED BY A LICENSED DESIGN PROFESSIONAL.
4. BITUMINOUS PLIES INCLUDE APPROPRIATE SMOOTH JM SBS MODIFIED BITUMEN SHEETS APPLIED WITH HOT ASPHALT, MBR COLD APPLICATION ADHESIVE, OR HEAT WELDING TECHNIQUES AND/OR PLY FELTS APPLIED IN HOT ASPHALT.
5. JM TPO EDGE SEALANT IS REQUIRED ON ALL CUT OR NON-ENCAPSULATED EDGES OF REINFORCED MEMBRANE. THIS INCLUDES FACTORY CUT MEMBRANE. SEE DETAIL T-MS-01.
6. JM APPROVED ADHESIVES FOR JM TPO FLEECE BACKED MEMBRANE ADHERED OVER BITUMINOUS PLIES INCLUDE HOT ASPHALT.

## Maximum Guarantee Term: 30 Years

Johns Manville is a manufacturer of commercial roofing products and offers this general conceptual information to you as a courtesy. This complimentary assistance is not to be used or relied upon by anyone as a substitute for professional engineering design and documentation required by building code, contract, or applicable law. By accepting these comments you agree they do not constitute any representations, endorsements of, or an assumption by Johns Manville of any liability for either the adequacy of design of this building or any other material not supplied by Johns Manville.

**Note:** For the most current information on general guidelines, please refer to the System Considerations tab under Commercial Roofing Products on the JM Roofing Web site. For specifications, flashing details and general installation information please refer to the Application Tools tab.

Refer to the Safe Use Instructions and product label prior to using this product.



## Prefabricated Metal Curb Base Flashing with Cant

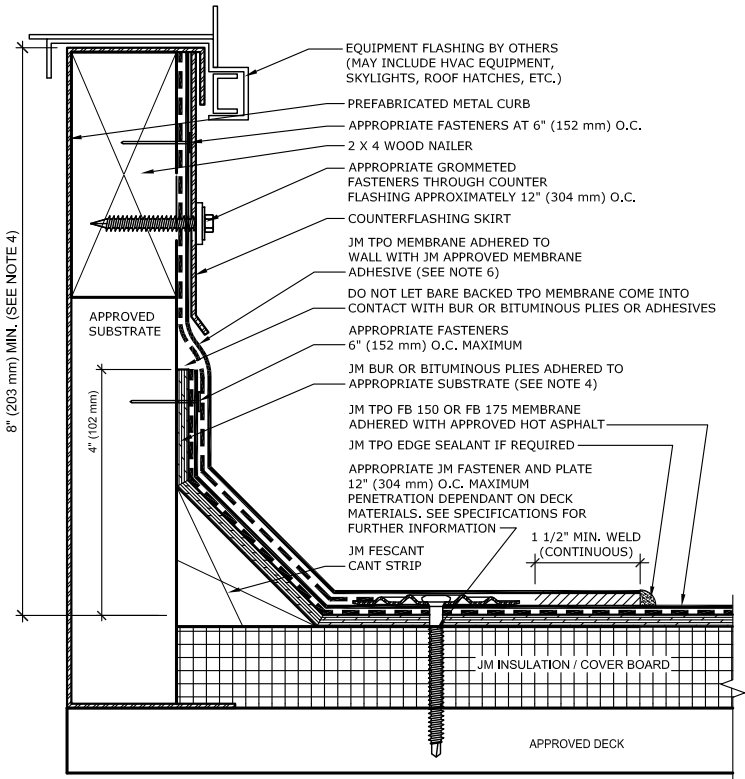

### NOTES:

1. REFER TO JOHNS MANVILLE WEBSITE ([www.jm.com](http://www.jm.com)) FOR MOST UP-TO-DATE INFORMATION.
2. PLEASE SEE SINGLE PLY FLASHING SPECIFICATIONS FOR A FULL DESCRIPTION OF INSTALLATION INSTRUCTIONS AND REQUIREMENTS WHICH ARE CONSIDERED A PART OF THIS DETAIL.
3. ANY CARPENTRY OR METAL WORK SHOULD BE DESIGNED AND CONSTRUCTED IN ACCORDANCE WITH LOCAL CODE REQUIREMENTS AND/OR PROJECT SPECIFICATIONS. THESE COMPONENTS SHOULD BE REVIEWED AND APPROVED BY A LICENSED DESIGN PROFESSIONAL.
4. BITUMINOUS PLIES INCLUDE APPROPRIATE SMOOTH JM SBS MODIFIED BITUMEN SHEETS APPLIED WITH HOT ASPHALT, MBR COLD APPLICATION ADHESIVE, OR HEAT WELDING TECHNIQUES AND/OR PLY FELTS APPLIED IN HOT ASPHALT.
5. JM TPO EDGE SEALANT IS REQUIRED ON ALL CUT OR NON-ENCAPSULATED EDGES OF REINFORCED MEMBRANE. THIS INCLUDES FACTORY CUT MEMBRANE. SEE DETAIL TH-MS-01.
6. JM APPROVED ADHESIVES FOR USE ON VERTICAL FLASHING APPLICATIONS INCLUDES JM LVOC MEMBRANE ADHESIVE (TPO & EPDM), JM MEMBRANE BONDING ADHESIVE (TPO & EPDM) AND TPO WATER BASED MEMBRANE ADHESIVE.
7. JM APPROVED ADHESIVES FOR JM TPO FLEECE BACKED MEMBRANE ADHERED OVER BITUMINOUS PLIES INCLUDE HOT ASPHALT.
8. HEIGHT OF CURB TO BE ADJUSTED WITH NAILERS. IT IS PREFERRED TO RAISE CURB ONTO NAILERS TO EXTEND FLASHING HEIGHT.
9. SEE TH-FW-B DETAILS FOR JM APPROVED BASE FLASHING TIE IN TERMINATION METHODS.

## Maximum Guarantee Term: 30 Years

Johns Manville is a manufacturer of commercial roofing products and offers this general conceptual information to you as a courtesy. This complimentary assistance is not to be used or relied upon by anyone as a substitute for professional engineering design and documentation required by building code, contract, or applicable law. By accepting these comments you agree they do not constitute any representations, endorsements of, or an assumption by Johns Manville of any liability for either the adequacy of design of this building or any other material not supplied by Johns Manville.

**Note:** For the most current information on general guidelines, please refer to the System Considerations tab under Commercial Roofing Products on the JM Roofing Web site. For specifications, flashing details and general installation information please refer to the Application Tools tab.

Refer to the Safe Use Instructions and product label prior to using this product.



## Prefabricated Metal Base Flashing

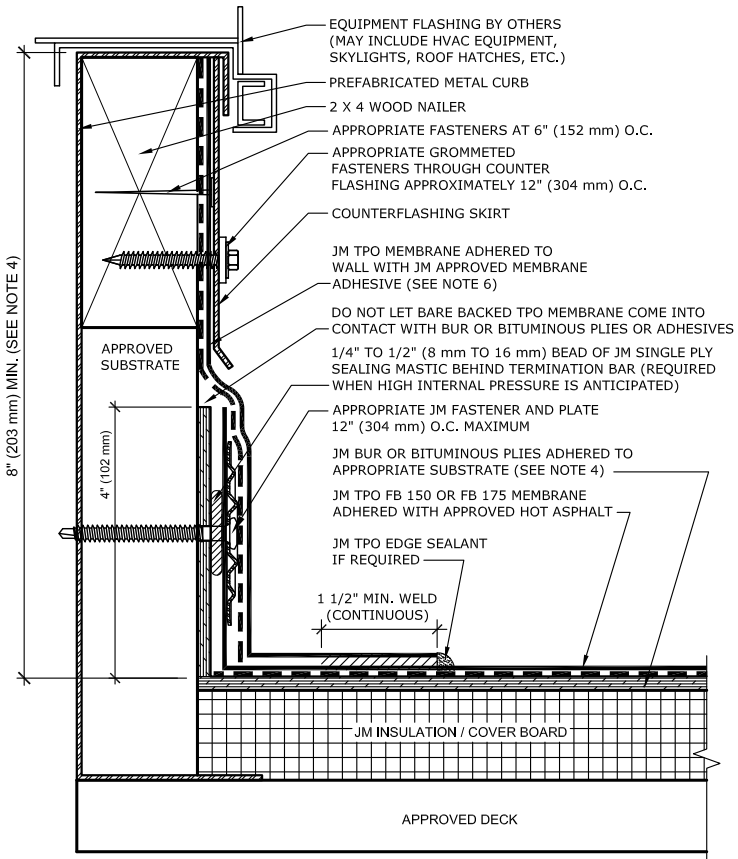

**NOTES:**

1. REFER TO JOHNS MANVILLE WEBSITE ([www.jm.com](http://www.jm.com)) FOR MOST UP-TO-DATE INFORMATION.
2. PLEASE SEE SINGLE PLY FLASHING SPECIFICATIONS FOR A FULL DESCRIPTION OF INSTALLATION INSTRUCTIONS AND REQUIREMENTS WHICH ARE CONSIDERED A PART OF THIS DETAIL.
3. ANY CARPENTRY OR METAL WORK SHOULD BE DESIGNED AND CONSTRUCTED IN ACCORDANCE WITH LOCAL CODE REQUIREMENTS AND/OR PROJECT SPECIFICATIONS. THESE COMPONENTS SHOULD BE REVIEWED AND APPROVED BY A LICENSED DESIGN PROFESSIONAL.
4. BITUMINOUS PLIES INCLUDE APPROPRIATE SMOOTH JM SBS MODIFIED BITUMEN SHEETS APPLIED WITH HOT ASPHALT, MBR COLD APPLICATION ADHESIVE, OR HEAT WELDING TECHNIQUES AND/OR PLY FELTS APPLIED IN HOT ASPHALT.
5. JM TPO EDGE SEALANT IS REQUIRED ON ALL CUT OR NON-ENCAPSULATED EDGES OF REINFORCED MEMBRANE. THIS INCLUDES FACTORY CUT MEMBRANE. SEE DETAIL TH-MS-01.
6. JM APPROVED ADHESIVES FOR USE ON VERTICAL FLASHING APPLICATIONS INCLUDES JM LVOC MEMBRANE ADHESIVE (TPO & EPDM), JM MEMBRANE BONDING ADHESIVE (TPO & EPDM) AND TPO WATER BASED MEMBRANE ADHESIVE.
7. JM APPROVED ADHESIVES FOR JM TPO FLEECE BACKED MEMBRANE ADHERED OVER BITUMINOUS PLIES INCLUDE HOT ASPHALT.
8. HEIGHT OF CURB TO BE ADJUSTED WITH NAILERS. IT IS PREFERRED TO RAISE CURB ONTO NAILERS TO EXTEND FLASHING HEIGHT.
9. SEE TH-FW-B DETAILS FOR JM APPROVED BASE FLASHING TIE IN TERMINATION METHODS.

## Maximum Guarantee Term: 30 Years

Johns Manville is a manufacturer of commercial roofing products and offers this general conceptual information to you as a courtesy. This complimentary assistance is not to be used or relied upon by anyone as a substitute for professional engineering design and documentation required by building code, contract, or applicable law. By accepting these comments you agree they do not constitute any representations, endorsements of, or an assumption by Johns Manville of any liability for either the adequacy of design of this building or any other material not supplied by Johns Manville.

**Note:** For the most current information on general guidelines, please refer to the System Considerations tab under Commercial Roofing Products on the JM Roofing Web site. For specifications, flashing details and general installation information please refer to the Application Tools tab.

Refer to the Safe Use Instructions and product label prior to using this product.



## Drip Edge - TPO-Coated Metal

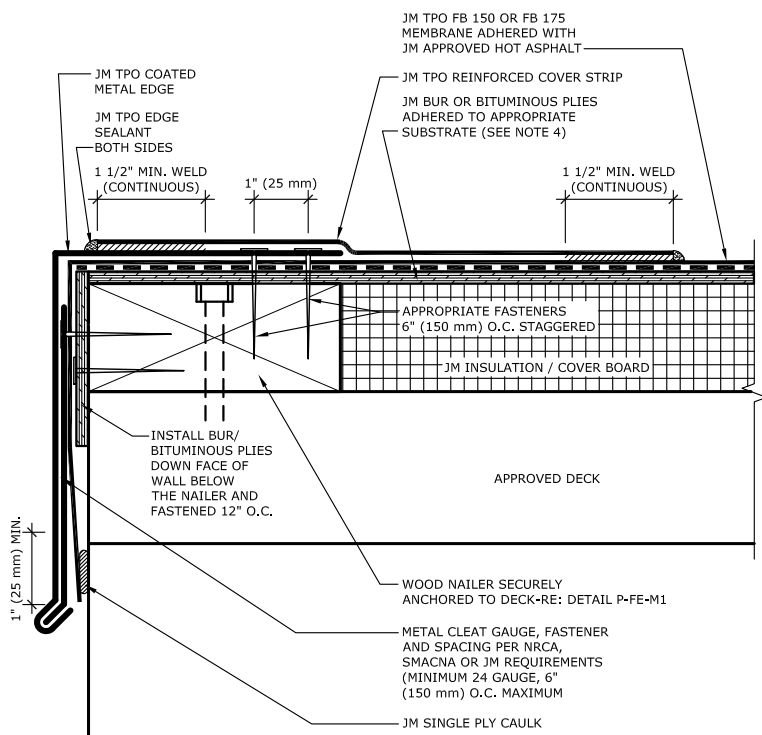

### NOTES:

- REFER TO JOHNS MANVILLE WEBSITE ([www.jm.com](http://www.jm.com)) FOR MOST UP-TO-DATE INFORMATION.
- PLEASE SEE SINGLE PLY FLASHING SPECIFICATIONS FOR A FULL DESCRIPTION OF INSTALLATION INSTRUCTIONS AND REQUIREMENTS WHICH ARE CONSIDERED A PART OF THIS DETAIL.
- ANY CARPENTRY OR METAL WORK SHOULD BE DESIGNED AND CONSTRUCTED IN ACCORDANCE WITH LOCAL CODE REQUIREMENTS AND/OR PROJECT SPECIFICATIONS. THESE COMPONENTS SHOULD BE REVIEWED AND APPROVED BY A LICENSED DESIGN PROFESSIONAL.
- BITUMINOUS PLIES INCLUDE APPROPRIATE SMOOTH JM SBS MODIFIED BITUMEN SHEETS APPLIED WITH HOT ASPHALT, MBR COLD APPLICATION ADHESIVE, OR HEAT WELDING TECHNIQUES AND/OR PLY FELTS APPLIED IN HOT ASPHALT.
- JM TPO EDGE SEALANT IS REQUIRED ON ALL CUT OR NON-ENCAPSULATED EDGES OF REINFORCED MEMBRANE. THIS INCLUDES FACTORY CUT MEMBRANE. SEE DETAIL T-MS-01.
- JM APPROVED ADHESIVES FOR JM TPO FLEECE BACKED MEMBRANE ADHERED OVER BITUMINOUS PLIES INCLUDE HOT ASPHALT.

## Maximum Guarantee Term: 30 Years

Johns Manville is a manufacturer of commercial roofing products and offers this general conceptual information to you as a courtesy. This complimentary assistance is not to be used or relied upon by anyone as a substitute for professional engineering design and documentation required by building code, contract, or applicable law. By accepting these comments you agree they do not constitute any representations, endorsements of, or an assumption by Johns Manville of any liability for either the adequacy of design of this building or any other material not supplied by Johns Manville.

**Note:** For the most current information on general guidelines, please refer to the System Considerations tab under Commercial Roofing Products on the JM Roofing Web site. For specifications, flashing details and general installation information please refer to the Application Tools tab.

Refer to the Safe Use Instructions and product label prior to using this product.



## Gravel Stop - TPO-Coated Metal

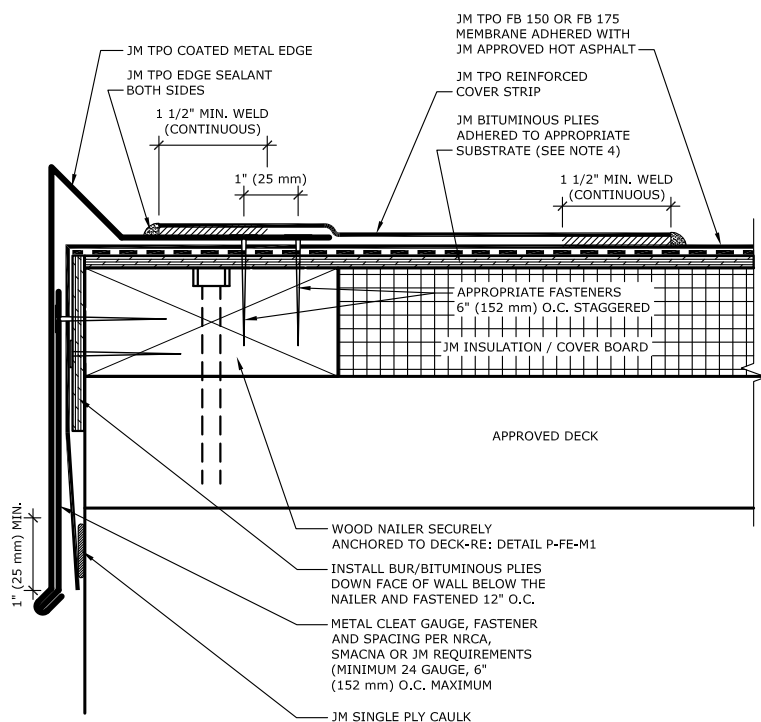

### NOTES:

- REFER TO JOHNS MANVILLE WEBSITE ([www.jm.com](http://www.jm.com)) FOR MOST UP-TO-DATE INFORMATION.
- PLEASE SEE SINGLE PLY FLASHING SPECIFICATIONS FOR A FULL DESCRIPTION OF INSTALLATION INSTRUCTIONS AND REQUIREMENTS WHICH ARE CONSIDERED A PART OF THIS DETAIL.
- ANY CARPENTRY OR METAL WORK SHOULD BE DESIGNED AND CONSTRUCTED IN ACCORDANCE WITH LOCAL CODE REQUIREMENTS AND/OR PROJECT SPECIFICATIONS. THESE COMPONENTS SHOULD BE REVIEWED AND APPROVED BY A LICENSED DESIGN PROFESSIONAL.
- BITUMINOUS PLYS INCLUDE APPROPRIATE SMOOTH JM SBS MODIFIED BITUMEN SHEETS APPLIED WITH HOT ASPHALT, MBR COLD APPLICATION ADHESIVE, OR HEAT WELDING TECHNIQUES AND/OR PLY FELTS APPLIED IN HOT ASPHALT.
- JM TPO EDGE SEALANT IS REQUIRED ON ALL CUT OR NON-ENCAPSULATED EDGES OF REINFORCED MEMBRANE. THIS INCLUDES FACTORY CUT MEMBRANE. SEE DETAIL T-MS-01.
- JM APPROVED ADHESIVES FOR JM TPO FLEECE BACKED MEMBRANE ADHERED OVER BITUMINOUS PLYS INCLUDE HOT ASPHALT.

## Maximum Guarantee Term: 30 Years

Johns Manville is a manufacturer of commercial roofing products and offers this general conceptual information to you as a courtesy. This complimentary assistance is not to be used or relied upon by anyone as a substitute for professional engineering design and documentation required by building code, contract, or applicable law. By accepting these comments you agree they do not constitute any representations, endorsements of, or an assumption by Johns Manville of any liability for either the adequacy of design of this building or any other material not supplied by Johns Manville.

**Note:** For the most current information on general guidelines, please refer to the System Considerations tab under Commercial Roofing Products on the JM Roofing Web site. For specifications, flashing details and general installation information please refer to the Application Tools tab.

Refer to the Safe Use Instructions and product label prior to using this product.



## Gutter & TPO-Coated Metal Edge

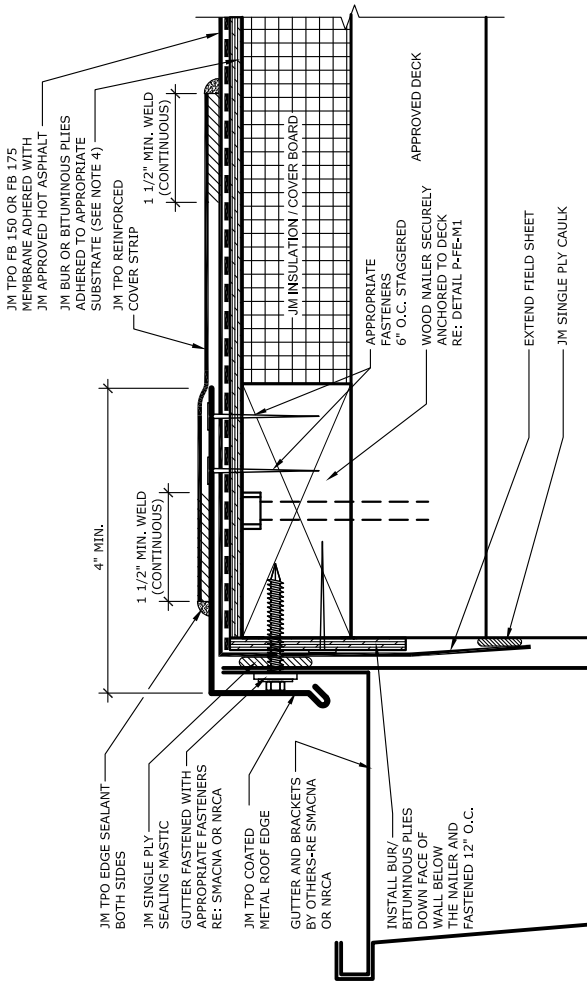

**NOTES:**

1. REFER TO JOHNS MANVILLE WEBSITE ([www.jm.com](http://www.jm.com)) FOR MOST UP-TO-DATE INFORMATION.
2. PLEASE SEE SINGLE PLY FLASHING SPECIFICATIONS FOR A FULL DESCRIPTION OF INSTALLATION INSTRUCTIONS AND REQUIREMENTS WHICH ARE CONSIDERED A PART OF THIS DETAIL.
3. ANY CARPENTRY OR METAL WORK SHOULD BE DESIGNED AND CONSTRUCTED IN ACCORDANCE WITH LOCAL CODE REQUIREMENTS AND/OR PROJECT SPECIFICATIONS. THESE COMPONENTS SHOULD BE REVIEWED AND APPROVED BY A LICENSED DESIGN PROFESSIONAL.
4. BITUMINOUS PLIES INCLUDE APPROPRIATE SMOOTH JM SBS MODIFIED BITUMEN SHEETS APPLIED WITH HOT ASPHALT, MBR COLD APPLICATION ADHESIVE, OR HEAT WELDING TECHNIQUES AND/OR PLY FELTS APPLIED IN HOT ASPHALT.
5. JM TPO EDGE SEALANT IS REQUIRED ON ALL CUT OR NON-ENCAPSULATED EDGES OF REINFORCED MEMBRANE. THIS INCLUDES FACTORY CUT MEMBRANE. SEE DETAIL T-MS-01.
6. JM APPROVED ADHESIVES FOR JM TPO FLEECE BACKED MEMBRANE ADHERED OVER BITUMINOUS PLIES INCLUDE HOT ASPHALT.

### Maximum Guarantee Term: 30 Years

Johns Manville is a manufacturer of commercial roofing products and offers this general conceptual information to you as a courtesy. This complimentary assistance is not to be used or relied upon by anyone as a substitute for professional engineering design and documentation required by building code, contract, or applicable law. By accepting these comments you agree they do not constitute any representations, endorsements of, or an assumption by Johns Manville of any liability for either the adequacy of design of this building or any other material not supplied by Johns Manville.

**Note:** For the most current information on general guidelines, please refer to the System Considerations tab under Commercial Roofing Products on the JM Roofing Web site. For specifications, flashing details and general installation information please refer to the Application Tools tab.

Refer to the Safe Use Instructions and product label prior to using this product.



## JM Presto-Tite Edge One Fascia System

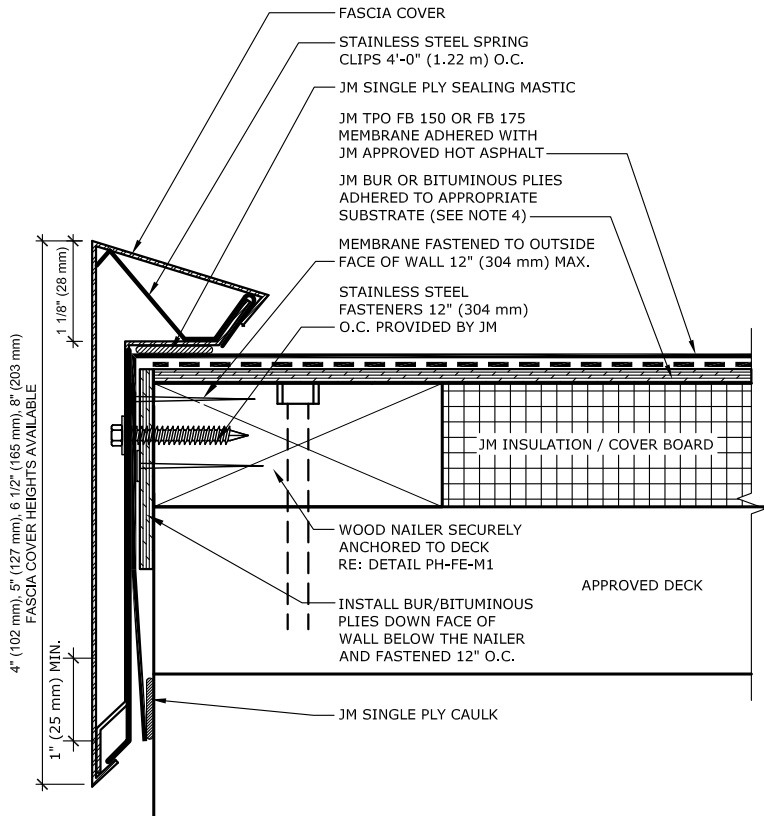

### NOTES:

1. REFER TO JOHNS MANVILLE WEBSITE ([www.jm.com](http://www.jm.com)) FOR MOST UP-TO-DATE INFORMATION.
2. PLEASE SEE SINGLE PLY FLASHING SPECIFICATIONS FOR A FULL DESCRIPTION OF INSTALLATION INSTRUCTIONS AND REQUIREMENTS WHICH ARE CONSIDERED A PART OF THIS DETAIL.
3. ANY CARPENTRY OR METAL WORK SHOULD BE DESIGNED AND CONSTRUCTED IN ACCORDANCE WITH LOCAL CODE REQUIREMENTS AND/OR PROJECT SPECIFICATIONS. THESE COMPONENTS SHOULD BE REVIEWED AND APPROVED BY A LICENSED DESIGN PROFESSIONAL.
4. BITUMINOUS PLIES INCLUDE APPROPRIATE SMOOTH JM SBS MODIFIED BITUMEN SHEETS APPLIED WITH HOT ASPHALT, MBR COLD APPLICATION ADHESIVE, OR HEAT WELDING TECHNIQUES AND/OR PLY FELTS APPLIED IN HOT ASPHALT.
5. JM TPO EDGE SEALANT IS REQUIRED ON ALL CUT OR NON-ENCAPSULATED EDGES OF REINFORCED MEMBRANE. THIS INCLUDES FACTORY CUT MEMBRANE. SEE DETAIL T-MS-01.
6. JM APPROVED ADHESIVES FOR JM TPO FLEECE BACKED MEMBRANE ADHERED OVER BITUMINOUS PLIES INCLUDE HOT ASPHALT.

## Maximum Guarantee Term: 30 Years

Johns Manville is a manufacturer of commercial roofing products and offers this general conceptual information to you as a courtesy. This complimentary assistance is not to be used or relied upon by anyone as a substitute for professional engineering design and documentation required by building code, contract, or applicable law. By accepting these comments you agree they do not constitute any representations, endorsements of, or an assumption by Johns Manville of any liability for either the adequacy of design of this building or any other material not supplied by Johns Manville.

**Note:** For the most current information on general guidelines, please refer to the System Considerations tab under Commercial Roofing Products on the JM Roofing Web site. For specifications, flashing details and general installation information please refer to the Application Tools tab.

Refer to the Safe Use Instructions and product label prior to using this product.





## JM Presto-Tite Fascia System

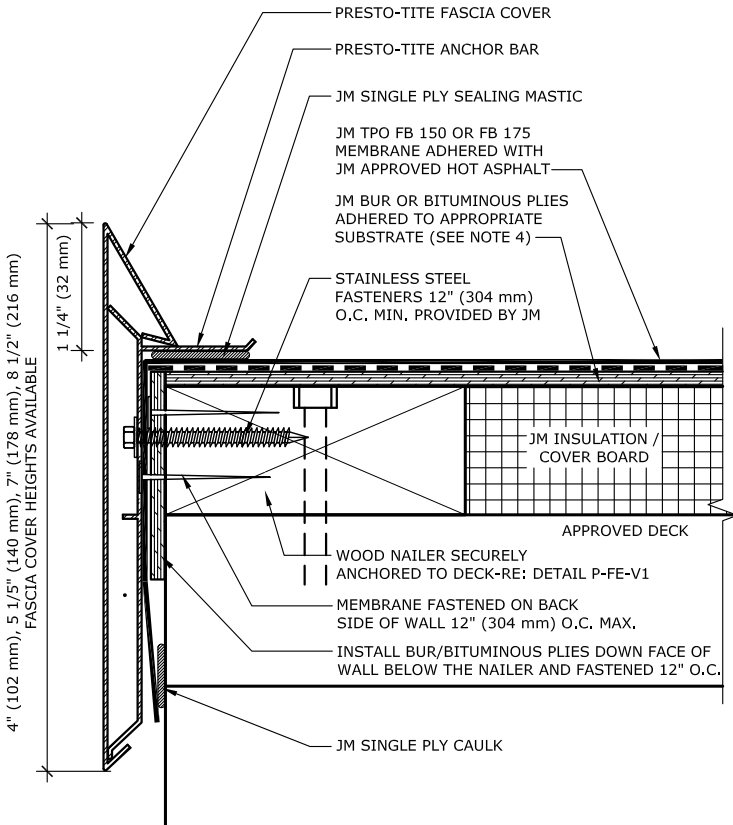

### NOTES:

1. REFER TO JOHNS MANVILLE WEBSITE ([www.jm.com](http://www.jm.com)) FOR MOST UP-TO-DATE INFORMATION.
2. PLEASE SEE SINGLE PLY FLASHING SPECIFICATIONS FOR A FULL DESCRIPTION OF INSTALLATION INSTRUCTIONS AND REQUIREMENTS WHICH ARE CONSIDERED A PART OF THIS DETAIL.
3. ANY CARPENTRY OR METAL WORK SHOULD BE DESIGNED AND CONSTRUCTED IN ACCORDANCE WITH LOCAL CODE REQUIREMENTS AND/OR PROJECT SPECIFICATIONS. THESE COMPONENTS SHOULD BE REVIEWED AND APPROVED BY A LICENSED DESIGN PROFESSIONAL.
4. BITUMINOUS PLIES INCLUDE APPROPRIATE SMOOTH JM SBS MODIFIED BITUMEN SHEETS APPLIED WITH HOT ASPHALT, MBR COLD APPLICATION ADHESIVE, OR HEAT WELDING TECHNIQUES AND/OR PLY FELTS APPLIED IN HOT ASPHALT.
5. JM TPO EDGE SEALANT IS REQUIRED ON ALL CUT OR NON-ENCAPSULATED EDGES OF REINFORCED MEMBRANE. THIS INCLUDES FACTORY CUT MEMBRANE. SEE DETAIL T-MS-01.
6. JM APPROVED ADHESIVES FOR JM TPO FLEECE BACKED MEMBRANE ADHERED OVER BITUMINOUS PLIES INCLUDE HOT ASPHALT.

## Maximum Guarantee Term: 30 Years

Johns Manville is a manufacturer of commercial roofing products and offers this general conceptual information to you as a courtesy. This complimentary assistance is not to be used or relied upon by anyone as a substitute for professional engineering design and documentation required by building code, contract, or applicable law. By accepting these comments you agree they do not constitute any representations, endorsements of, or an assumption by Johns Manville of any liability for either the adequacy of design of this building or any other material not supplied by Johns Manville.

**Note:** For the most current information on general guidelines, please refer to the System Considerations tab under Commercial Roofing Products on the JM Roofing Web site. For specifications, flashing details and general installation information please refer to the Application Tools tab.

Refer to the Safe Use Instructions and product label prior to using this product.



## Field Fabricated Vent Pipe

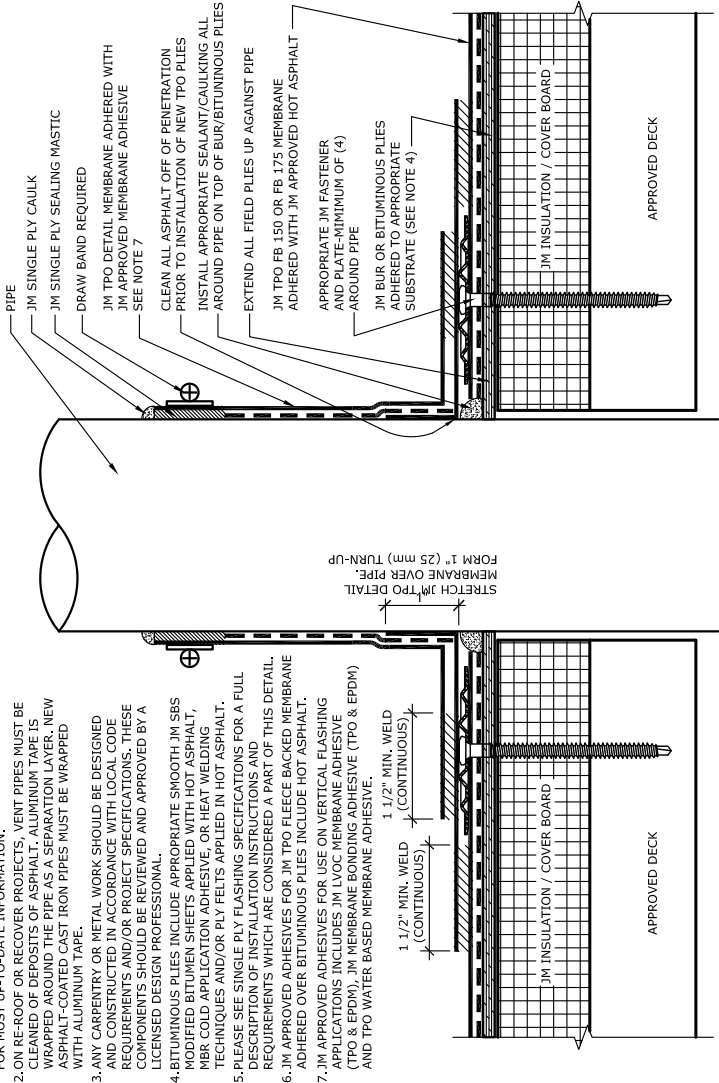

**NOTES:**

1. REFER TO JOHN'S MANVILLE WEBSITE ([www.jm.com](http://www.jm.com)) FOR MOST UP-TO-DATE INFORMATION.
2. ON RE-ROOF OR RECOVER PROJECTS, VENT PIPES MUST BE CLEANED OF DEPOSITS OF ASPHALT, ALUMINUM TAPE IS WRAPPED AROUND THE PIPE AS A SEPARATION LAYER. NEW ASPHALT-COATED CAST IRON PIPES MUST BE WRAPPED WITH ALUMINUM TAPE.
3. ANY CARPENTRY OR METAL WORK SHOULD BE DESIGNED AND CONSTRUCTED IN ACCORDANCE WITH LOCAL CODE REQUIREMENTS AND/OR PROJECT SPECIFICATIONS. THESE COMPONENTS SHOULD BE REVIEWED AND APPROVED BY A LICENSED DESIGN PROFESSIONAL.
4. BITUMINOUS PLIES INCLUDE APPROPRIATE SMOOTH JM SBS MODIFIED BITUMEN SHEETS APPLIED WITH HOT ASPHALT, MBR COLD APPLICATION ADHESIVE, OR HEAT WELDING, TECHNIQUES AND/OR PLY FELTS APPLIED IN HOT ASPHALT.
5. PLEASE SEE SINGLE PLY FLASHING SPECIFICATIONS FOR A FULL DESCRIPTION OF INSTALLATION INSTRUCTIONS AND REQUIREMENTS WHICH ARE CONSIDERED A PART OF THIS DETAIL.
6. JM APPROVED ADHESIVES FOR JM TPO FLEECE BACKED MEMBRANE ADHERED OVER BITUMINOUS PLIES INCLUDE HOT ASPHALT.
7. JM APPROVED ADHESIVES FOR USE ON VERTICAL FLASHING APPLICATIONS INCLUDES JM LVOC MEMBRANE ADHESIVE (TPO & EPDM), JM MEMBRANE BONDING ADHESIVE (TPO & EPDM) AND TPO WATER BASED MEMBRANE ADHESIVE.

### Maximum Guarantee Term: 30 Years

Johns Manville is a manufacturer of commercial roofing products and offers this general conceptual information to you as a courtesy. This complimentary assistance is not to be used or relied upon by anyone as a substitute for professional engineering design and documentation required by building code, contract, or applicable law. By accepting these comments you agree they do not constitute any representations, endorsements of, or an assumption by Johns Manville of any liability for either the adequacy of design of this building or any other material not supplied by Johns Manville.

**Note:** For the most current information on general guidelines, please refer to the System Considerations tab under Commercial Roofing Products on the JM Roofing Web site. For specifications, flashing details and general installation information please refer to the Application Tools tab.

Refer to the Safe Use Instructions and product label prior to using this product.



## Drain Detail

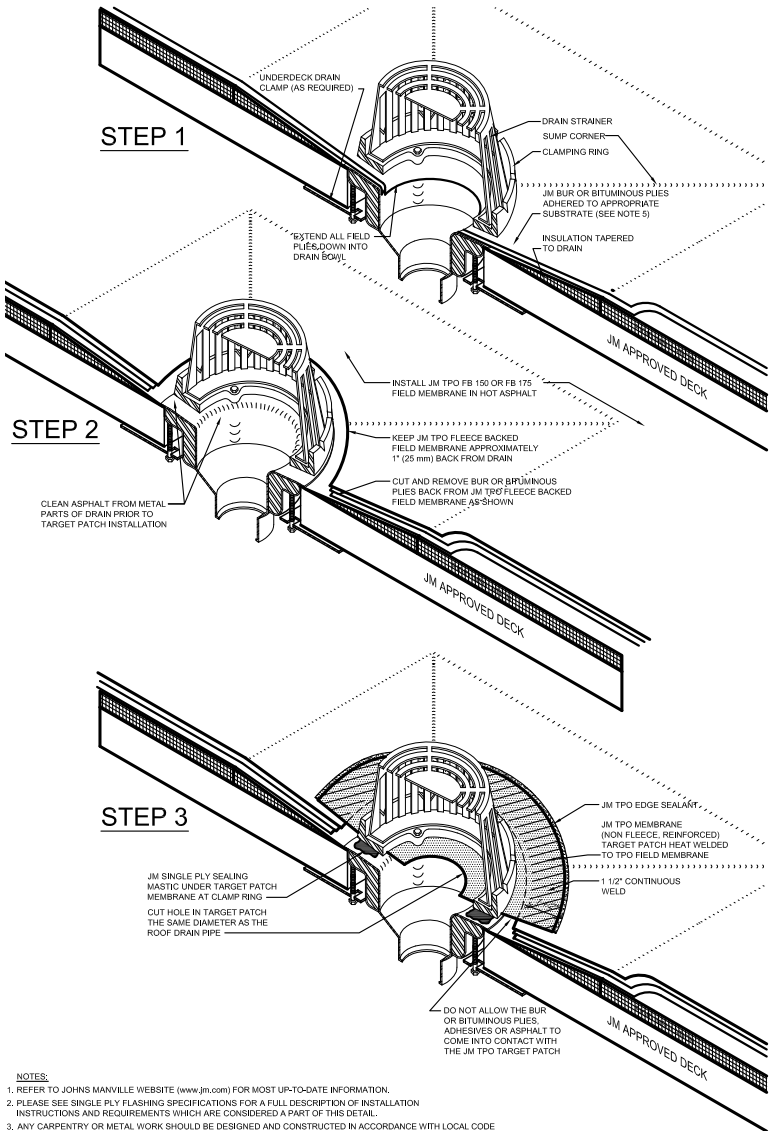

- NOTES:**
- REFER TO JOHNS MANVILLE WEBSITE ([www.jm.com](http://www.jm.com)) FOR MOST UP-TO-DATE INFORMATION.
  - PLEASE SEE SINGLE PLY FLASHING SPECIFICATIONS FOR A FULL DESCRIPTION OF INSTALLATION INSTRUCTIONS AND REQUIREMENTS WHICH ARE CONSIDERED A PART OF THIS DETAIL.
  - ANY CARPENTRY OR METAL WORK SHOULD BE DESIGNED AND CONSTRUCTED IN ACCORDANCE WITH LOCAL CODE REQUIREMENTS AND/OR PROJECT SPECIFICATIONS. THESE COMPONENTS SHOULD BE REVIEWED AND APPROVED BY A LICENSED DESIGN PROFESSIONAL.
  - JM TPO EDGE SEALANT IS REQUIRED ON ALL CUT OR NON-ENCAPSULATED EDGE OF REINFORCED MEMBRANE. THIS INCLUDES FACTORY CUT MEMBRANE. SEE DETAIL TMS-01.
  - BITUMINOUS PILES INCLUDE APPROPRIATE SMOOTH JM SBS MODIFIED BITUMEN SHEETS APPLIED WITH HOT ASPHALT, MBR COLD APPLICATION ADHESIVE, OR HEAT WELDING TECHNIQUES AND/OR BUR PLY FELTS APPLIED IN HOT ASPHALT OR COLD APPLICATION ADHESIVE.
  - JM APPROVED ADHESIVES FOR JM TPO FB 150 & 175 MEMBRANE ADHERED OVER BITUMINOUS PILES INCLUDE HOT ASPHALT.

## Maximum Guarantee Term: 30 Years

Johns Manville is a manufacturer of commercial roofing products and offers this general conceptual information to you as a courtesy. This complimentary assistance is not to be used or relied upon by anyone as a substitute for professional engineering design and documentation required by building code, contract, or applicable law. By accepting these comments you agree they do not constitute any representations, endorsements of, or an assumption by Johns Manville of any liability for either the adequacy of design of this building or any other material not supplied by Johns Manville.

**Note:** For the most current information on general guidelines, please refer to the System Considerations tab under Commercial Roofing Products on the JM Roofing Web site. For specifications, flashing details and general installation information please refer to the Application Tools tab.

Refer to the Safe Use Instructions and product label prior to using this product.



## Vent Pipe

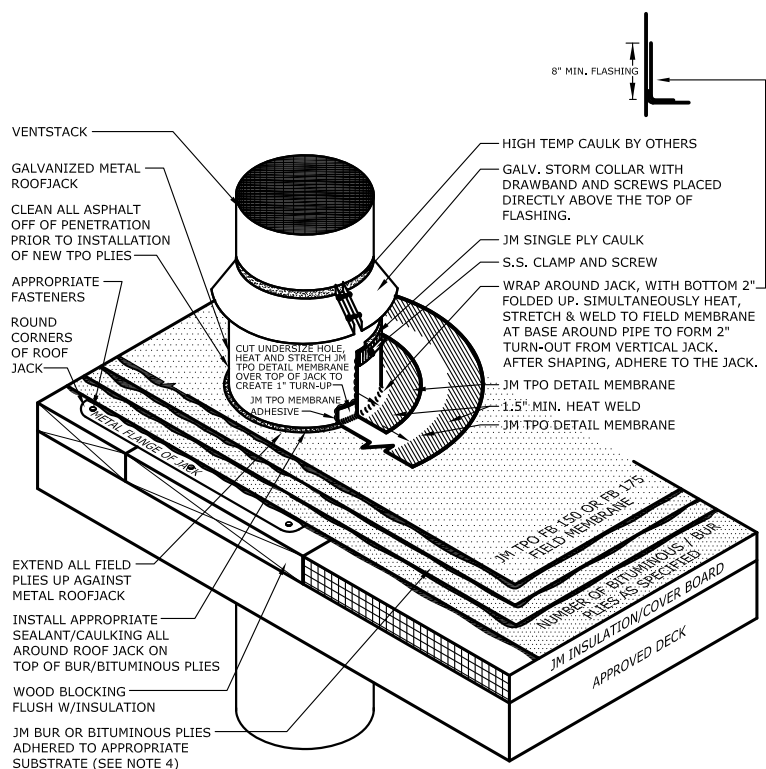

### NOTES:

1. REFER TO JOHNS MANVILLE WEBSITE ([www.Jm.com](http://www.Jm.com)) FOR MOST UP-TO-DATE INFORMATION.
2. PLEASE SEE SINGLE PLY FLASHING SPECIFICATIONS FOR A FULL DESCRIPTION OF INSTALLATION INSTRUCTIONS AND REQUIREMENTS WHICH ARE CONSIDERED A PART OF THIS DETAIL.
3. ANY CARPENTRY OR METAL WORK SHOULD BE DESIGNED AND CONSTRUCTED IN ACCORDANCE WITH LOCAL CODE REQUIREMENTS AND/OR PROJECT SPECIFICATIONS. THESE COMPONENTS SHOULD BE REVIEWED AND APPROVED BY A LICENSED DESIGN PROFESSIONAL.
4. BITUMINOUS PLIES INCLUDE APPROPRIATE SMOOTH JM SBS MODIFIED BITUMEN SHEETS APPLIED WITH HOT ASPHALT, MBR COLD APPLICATION ADHESIVE, OR HEAT WELDING TECHNIQUES AND/OR PLY FELTS APPLIED IN HOT ASPHALT.
5. JM TPO EDGE SEALANT IS REQUIRED ON ALL CUT OR NON-ENCAPSULATED EDGES OF REINFORCED MEMBRANE. THIS INCLUDES FACTORY CUT MEMBRANE. SEE DETAIL T-MS-01.
6. JM APPROVED ADHESIVES FOR JM TPO FLEECE BACKED MEMBRANE ADHERED OVER BITUMINOUS PLIES INCLUDE HOT ASPHALT.

## Maximum Guarantee Term: 30 Years

Johns Manville is a manufacturer of commercial roofing products and offers this general conceptual information to you as a courtesy. This complimentary assistance is not to be used or relied upon by anyone as a substitute for professional engineering design and documentation required by building code, contract, or applicable law. By accepting these comments you agree they do not constitute any representations, endorsements of, or an assumption by Johns Manville of any liability for either the adequacy of design of this building or any other material not supplied by Johns Manville.

**Note:** For the most current information on general guidelines, please refer to the System Considerations tab under Commercial Roofing Products on the JM Roofing Web site. For specifications, flashing details and general installation information please refer to the Application Tools tab.

Refer to the Safe Use Instructions and product label prior to using this product.



## Pipe Boot

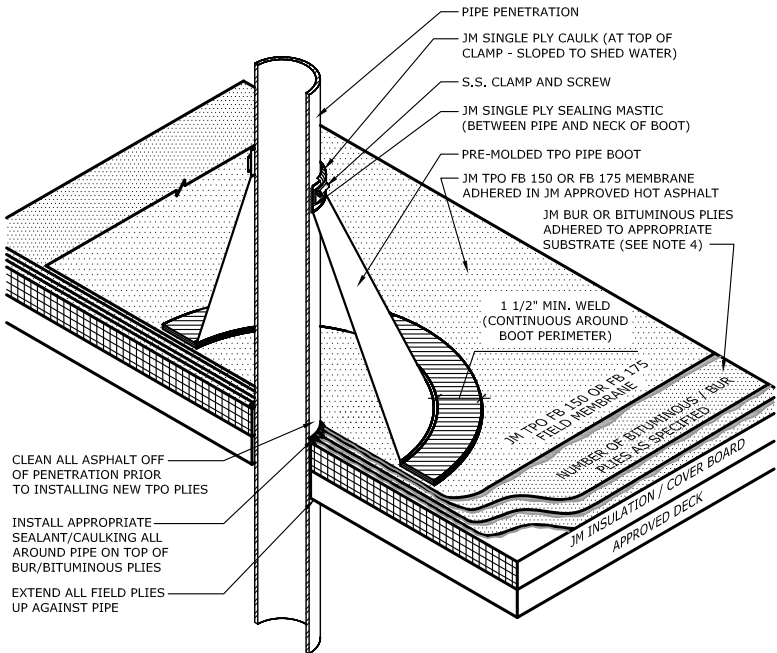

### NOTES:

1. REFER TO JOHNS MANVILLE WEBSITE ([www.jm.com](http://www.jm.com)) FOR MOST UP-TO-DATE INFORMATION.
2. PLEASE SEE SINGLE PLY FLASHING SPECIFICATIONS FOR A FULL DESCRIPTION OF INSTALLATION INSTRUCTIONS AND REQUIREMENTS WHICH ARE CONSIDERED A PART OF THIS DETAIL.
3. ANY CARPENTRY OR METAL WORK SHOULD BE DESIGNED AND CONSTRUCTED IN ACCORDANCE WITH LOCAL CODE REQUIREMENTS AND/OR PROJECT SPECIFICATIONS. THESE COMPONENTS SHOULD BE REVIEWED AND APPROVED BY A LICENSED DESIGN PROFESSIONAL.
4. BITUMINOUS PLIES INCLUDE APPROPRIATE SMOOTH JM SBS MODIFIED BITUMEN SHEETS APPLIED WITH HOT ASPHALT, MBR COLD APPLICATION ADHESIVE, OR HEAT WELDING TECHNIQUES AND/OR PLY FELTS APPLIED IN HOT ASPHALT.
5. JM TPO EDGE SEALANT IS REQUIRED ON ALL CUT OR NON-ENCAPSULATED EDGES OF REINFORCED MEMBRANE. THIS INCLUDES FACTORY CUT MEMBRANE. SEE DETAIL T-MS-01.
6. JM APPROVED ADHESIVES FOR JM TPO FLEECE BACKED MEMBRANE ADHERED OVER BITUMINOUS PLIES INCLUDE HOT ASPHALT.

## Maximum Guarantee Term: 30 Years

Johns Manville is a manufacturer of commercial roofing products and offers this general conceptual information to you as a courtesy. This complimentary assistance is not to be used or relied upon by anyone as a substitute for professional engineering design and documentation required by building code, contract, or applicable law. By accepting these comments you agree they do not constitute any representations, endorsements of, or an assumption by Johns Manville of any liability for either the adequacy of design of this building or any other material not supplied by Johns Manville.

**Note:** For the most current information on general guidelines, please refer to the System Considerations tab under Commercial Roofing Products on the JM Roofing Web site. For specifications, flashing details and general installation information please refer to the Application Tools tab.

Refer to the Safe Use Instructions and product label prior to using this product.





# PEAK *Johns Manville* ADVANTAGE

## One manufacturer, one full-system guarantee

Johns Manville offers the most comprehensive guarantee in the roofing industry. That's the advantage you can expect from a longtime, dependable leader in the roofing industry along with the financial backing from Berkshire Hathaway.



[facebook.com/JohnsManville](https://www.facebook.com/JohnsManville)



[@JMRoofingSystem](https://twitter.com/JMRoofingSystem)



[JohnsManvillevideos](https://www.youtube.com/JohnsManvillevideos)



[www.jmroofing.news](http://www.jmroofing.news)



717 17th St,  
Denver, CO 80202  
(800) 922-5922

[www.jm.com/roofing](http://www.jm.com/roofing)